ECAM22X.2Y - 22X.3Y

MAGNIFICA START

QUICK GUIDE



DeLonghi

- IT-** Prima di utilizzare l'apparecchio leggere sempre il fascicolo delle avvertenze di sicurezza. Per ulteriori indicazioni sul funzionamento, fare riferimento alle ulteriori indicazioni nel fascicolo "Istruzioni per l'uso".
- EN-** Always read the safety warnings before using the appliance. For more instructions, read the Instruction for use .
- DE-** Vor dem Gebrauch des Gerätes lesen Sie bitte immer das Heft mit den Sicherheitshinweisen durch.. Für weitere Informationen zum Betrieb wird auf die Angaben im Heft „Bedienungsanleitung“ verwiesen.
- FR-** Avant d'utiliser l'appareil toujours lire les consignes de sécurité. Pour de plus amples indications sur le fonctionnement, se référer aux indications dans le "Mode d'emploi".
- NL-** Voordat het apparaat wordt gebruikt, moet altijd het document met de veiligheidsaanschuwingen worden gelezen. Verwijs voor meer aanwijzingen over de werking naar de aanwijzingen van het document "Gebruiksaanwijzing".
- ES-** Antes de utilizar el aparato lea siempre el fascículo de las advertencias de seguridad. Para indicaciones adicionales sobre el funcionamiento, consulte las indicaciones adicionales en el fascículo "Instrucciones para el uso".
- PT-** Antes de utilizar o aparelho, leia sempre o livreto das advertências de segurança. Para mais indicações acerca do funcionamento, consulte as indicações adicionais no livreto "Instruções de utilização".
- EL-** Διαβάξτε πάντα τις προειδοποιήσεις ασφαλείας προτού χρησιμοποιήσετε τη συσκευή. Για περισσότερες οδηγίες σχετικά με τη λειτουργία, διαβάστε το εγχειρίδιο «Οδηγίες χρήσης».
- NO-** Før apparatet tas i bruk må man alltid lese heftet med sikkerhetsadvarsler. For ytterligere informasjon angående funksjonen, må man lese igjennom ytterligere indikasjoner i heftet "Bruksanvisning".
- SV-** Innan du använder apparaten läs alltid häftet med säkerhetsvarningarna. För ytterligare anvisningar beträffande dess funktion, se de ytterligare anvisningarna i häftet "Bruksanvisning".
- DA-** Læs altid sikkerhedsadvarselne inden du bruger maskinen. Se yderligere information i hæftet "Betjeningsvejledning" for yderligere driftsoplysninger.
- FI-** Lue aina turvallisuusvaroitusten vihkonen ennen laitteen käyttöä. Jos tahdot lisäohjeita käyttöä varten, katso "Käyttöohjeet"-vihkosta.
- RU-** Перед использованием устройства обязательно прочитайте руководство по безопасности. Для получения дополнительной информации о работе см. дополнительную информацию в пособии «Руководство по эксплуатации».
- UK-** Завжди читайте попередження щодо безпеки перед використанням приладу. Щоб отримати додаткові вказівки, прочитайте Інструкцію по застосуванню.
- KZ-** Құрылғыны пайдаланбас бұрын, әрқашан қауіпсіздік ескертулерін оқып алыңыз. Қосымша нұсқауларды Пайдаланушы нұсқаулығынан көріңіз.
- HU-** Mielőtt használná a készüléket, mindig olvassa el a biztonsági figyelmeztetések dossziéját. A működéssel kapcsolatos további információért lásd a „Használati utasítás” dosszié útmutatásait.
- CS-** Před použitím přístroje si vždy přečtěte dokument s bezpečnostními varováními. Další informace o provozu najdete v doplňkových informacích v dokumentu „Návod k použití“.
- SK-** Pred používaním spotrebiča si vždy prečítajte dokumentáciu bezpečnostných upozornení. Viac informácií o prevádzke nájdete v ďalších informáciách v dokumentácii „Návod na použitie“.
- PL-** Przed rozpoczęciem użytkowania, należy uważnie przeczytać broszurę, w której wskazano ostrzeżenia dotyczące bezpieczeństwa. Więcej informacji na temat funkcjonowania wskazano w dodatkowych wskazówkach w „Instrukcji obsługi”.
- HR-** Prije uporabe uređaja uvijek pročitajte sigurnosna upozorenja. Dodatne informacije o radu potražite u dodatnim informacijama u knjižici "Upute za uporabu".
- SL-** Pred uporabo aparata vedno preberite zvezek z varnostnimi opozorili. Za več informacij o delovanju glejte dodatne napotke v zvezku »Navodila za uporabo«.
- SR-** Pre korišćenja aparata uvek pročitajte dokumente s bezbednosnim upozorenjima. Za najnovije indikacije o radu pogledajte najnovije indikacije iz dokumenata „Uputstva za upotrebu”.
- BG-** Преди да използвате уреда, прочетете винаги предупрежденията за безопасност. За допълнителни инструкции относно функционирането, консултирайте допълнителните инструкции в свитъка "Инструкции за употреба".
- RO-** Înainte de a utiliza aparatul, citiți întotdeauna broșura cu avertismente de siguranță. Pentru informații suplimentare cu privire la funcționare, consultați informațiile suplimentare din broșura „Instrucțiuni de utilizare”.
- TR-** Cihazı kullanmadan önce daima güvenlik uyarılarını bölümünü okuyun. Çalışmasıyla ilgili daha fazla bilgi almak için "Kullanım talimatları" bölümünde yer alan diğer talimatlara başvurun.

- AR قبل استخدام الجهاز اقرأ دائماً ملف تحذيرات الأمان. لمزيد من المعلومات حول التشغيل ارجع إلى التوضيحات والتنبيهات الإضافية الواردة في ملف «إرشادات الاستخدام».

- FA همیشه قبل از استفاده از دستگاه، هشدارهای ایمنی را بخوانید. برای اطلاع از دستورالعمل‌های بیشتر، دستورالعمل استفاده را بخوانید.

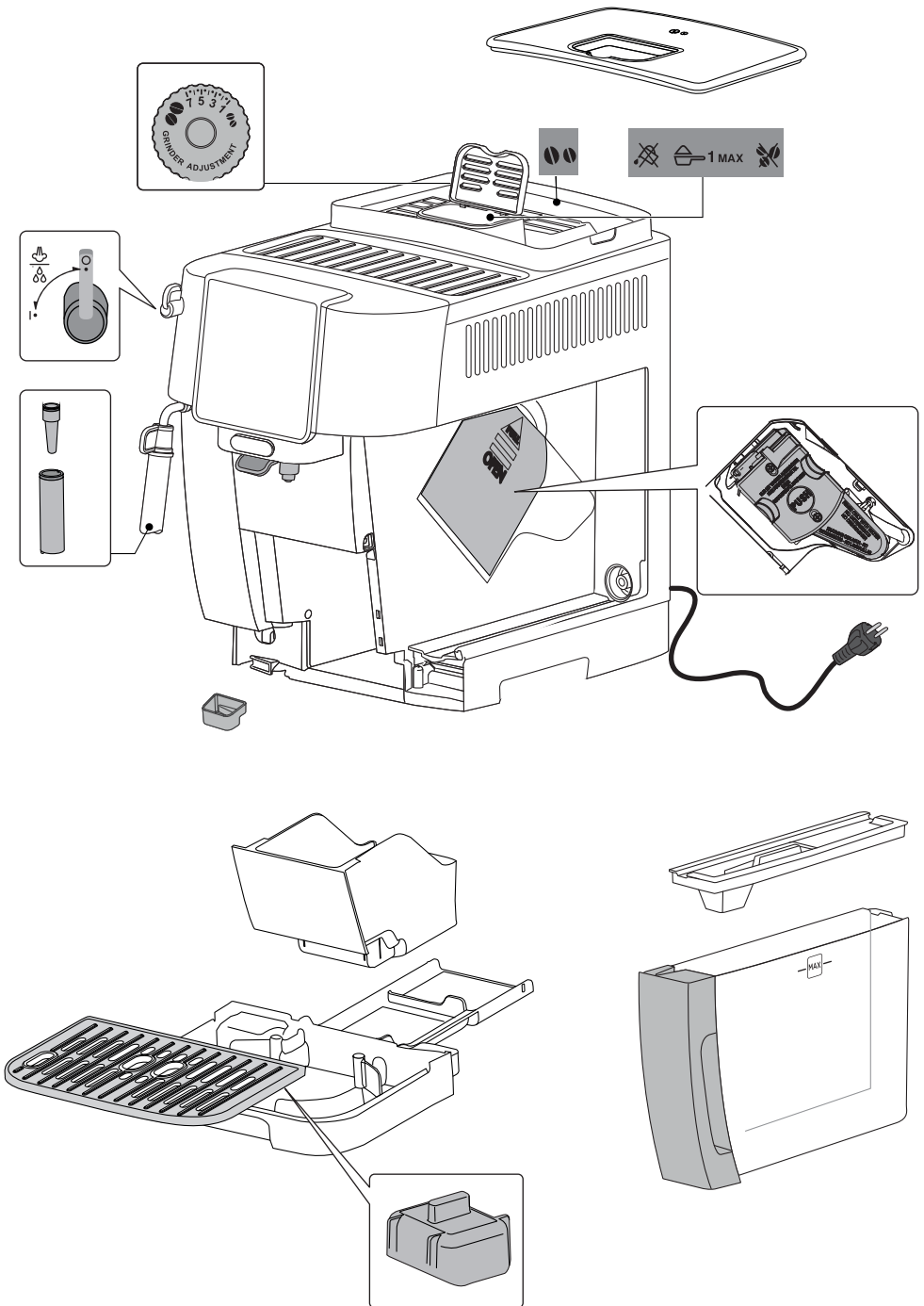

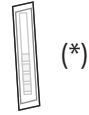
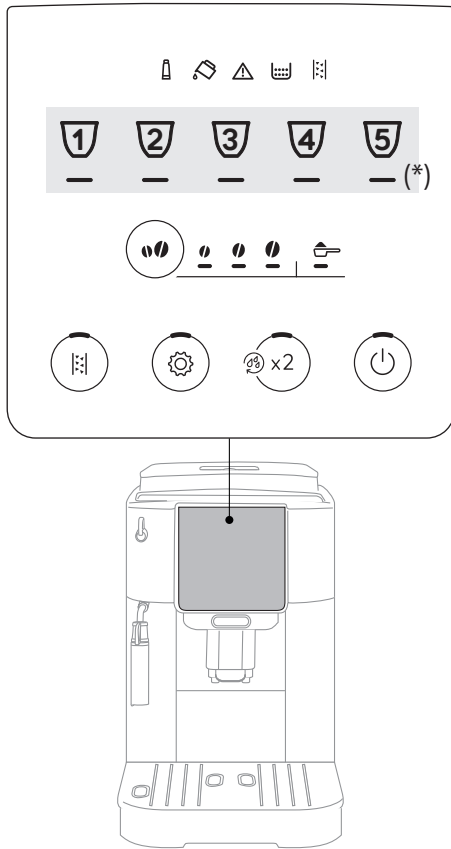

(*)

- IT Bevande e accessori diversi per tipo e numero a seconda del modello.
- EN The type and number of beverages and accessories differ according to model.
- DE Die Art und Anzahl der Getränke und Zubehörteile kann je nach Modell abweichen.
- FR Le type et le nombre de boissons et d'accessoires différent suivant le modèle.
- NL Het type en aantal van de dranken en de accessoires kunnen afhangen van het model verschillen.
- ES Bebidas y accesorios diversos por tipo y número según el modelo.
- PT Bebidas e acessórios diferentes por tipo e número consoante o modelo.
- EL Ο τύπος και ο αριθμός των ροφημάτων και των αξεσουάρ διαφέρουν αναλόγως το μοντέλο.
- NO Type og nummer for hver enkelt drikk avhenger av modell.
- SV Drycker och tillbehör är olika i typ och antal, beroende på modellen.
- DA Drikke og andet tilbehør efter type og nummer afhængigt af model.

- FI Valittavissa olevien juomien ja lisävarusteiden tyyppi ja lukumäärä ovat mallikohtaisia.
- RU Напитки и аксессуары отличаются по типу и количеству в зависимости от модели.
- UK Тип та кількість напоїв та аксесуарів відрізняються залежно від моделі.
- KZ Сусындар мен керек-жарақтардың түрлері мен саны әр модельде әртүрлі болады.
- HU Típus és szám szerint eltérő italok és tartozékok a modell alapján.
- CS Nápoje a různá příslušenství podle typu a čísla v závislosti na modelu.
- SK Rôzne nápoje a príslušenstvo podľa typu a čísla podľa modelu.
- PL Napoje i akcesoria różnego rodzaju i ilości, w zależności od modelu.
- HR Napitci i dodaci se razlikuju prema vrsti i broju, ovisno o modelu.
- SL Drugačen tip in število napitkov in pripomočkov glede na model.
- SR Pića i različiti pribor za vrstu i broj u skladu s modelom.
- BG Напитки и аксесоари, различни по вид и брой, според модела.
- RO Băuturi și accesorii diferite pentru tip și număr în funcție de model.
- TR İçecekler ve aksesuarların tür ve sayıları modele göre değişiklik gösterir.

AR مشروبات وملحقات تشغيلية مختلفة من حيث النوع والعدد وفقاً للموديل.

FA نوع و تعداد نوشیدنی ها و لوازم جانبی با توجه به مدل دستگاه متفاوت هستند.



DeLonghi



Per completare correttamente il primo avvio, la manopola deve essere in pos. 0 • Make sure the steam knob is on 0 pos. for the whole operation • Pour compléter correctement le premier démarrage, la manette doit être positionnée sur 0 • Um die erste Inbetriebnahme korrekt zu beenden, muss der Drehknopf auf Pos. 0 stehen • Om de eerste inwerkingstelling correct te voltooien, moet de knop geplaatst zijn op stand 0 • Para completar correctamente la primera puesta en funcionamiento, el mando debe estar en la pos. 0 • Para realizar correctamente o primeiro arranque, o manípulo deve estar na pos. 0 • Για να ολοκληρωθεί σωστά η αρχική εκκίνηση λειτουργίας, ο διακόπτης πρέπει να είναι στη θέση 0 • For å fullføre første oppstart korrekt må bryteren være i pos. 0 • För att fullborda den första starten korrekt, ska vredet vara i läge. 0 • Pre správné dokončenie prvého spustenia musí byť gombík v pol. 0 • Aby pravidelno dokončili prvého spuštění musí být knoflík v pol. 0 • Pre správne dokončenie prvého spustenia musí byť gombík v pol. 0 • Aby prawidłowo zakończyć pierwsze uruchomienie, pokrętkę musi się znajdować w poz. 0 • Za ispravno dovršenje prvog pokretanja, ručica mora biti u poz. 0 • Da bi pravilno zaključili prvi zagon, mora biti ručica na pol. 0 • Za ispravno završetak prvog pokretanja, ručica mora da bude u pol. 0 • Asigurati-vă că butonul pentru abur este în poziția 0 • Переконайтеся, що ручка подачі пари знаходиться в положенні 0 • Pentru a finaliza corect prima punere în funcțiune, butonul rotativ trebuie să fie pe poz. 0 • İlk başlatmayı doğru şekilde tamamlamak için düğmenin 0 konumunda olması gerekir

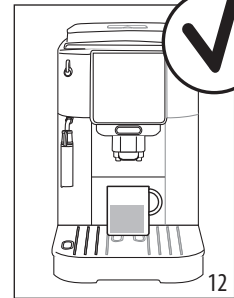
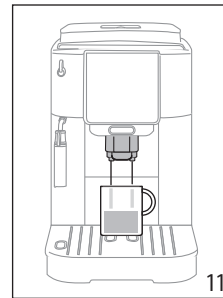
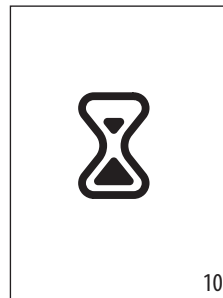
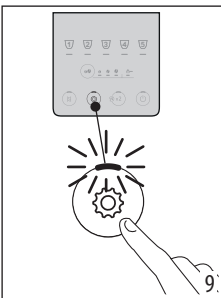
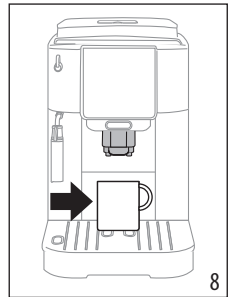
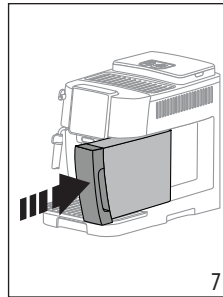
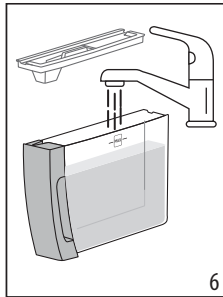
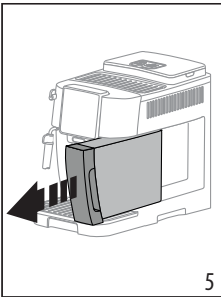
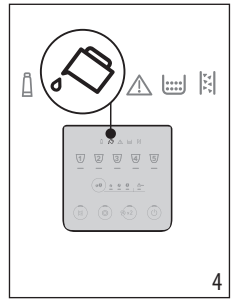
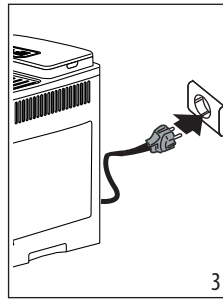
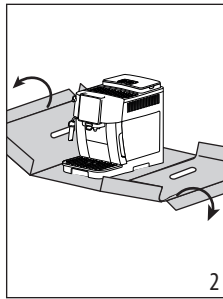
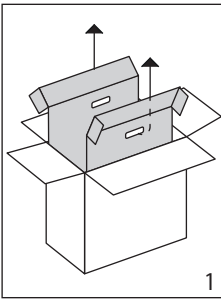

لإتمام بدء التشغيل الأول بطريقة صحيحة، يجب أن يكون المقبض في الموضع 0 • برای تکمیل صحیح تنظیمات دستگاه، گردونه بخار باید در حالت «0» قرار داشته باشد.

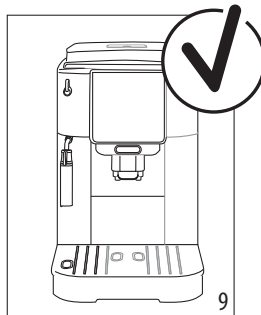
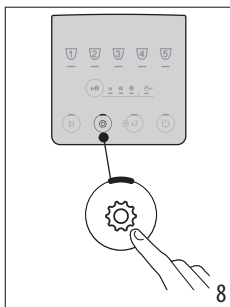
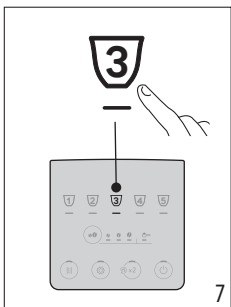
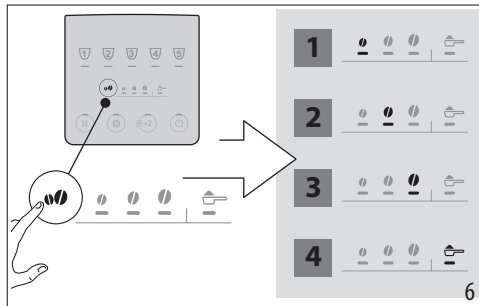
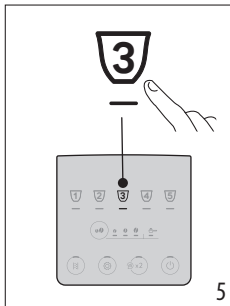
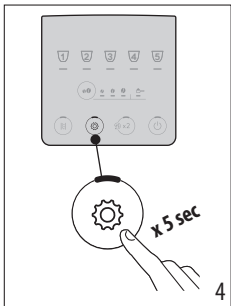
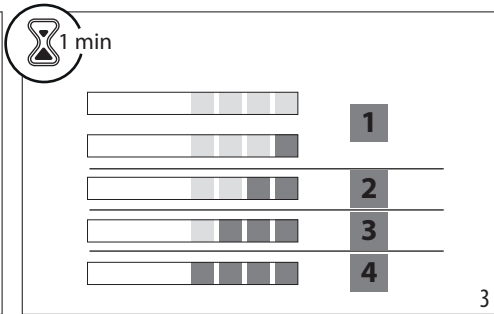
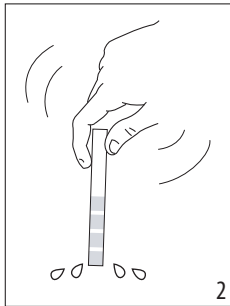
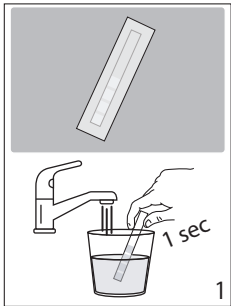

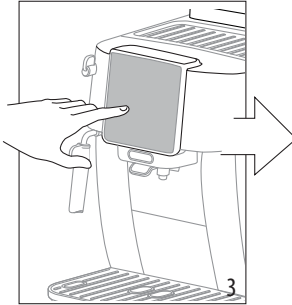
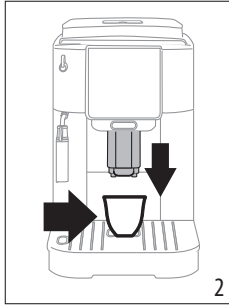
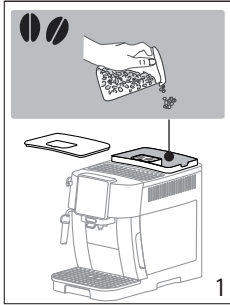



(*)

-  Espresso
-  Coffee
-  Long
-  Doppio+
-  Americano

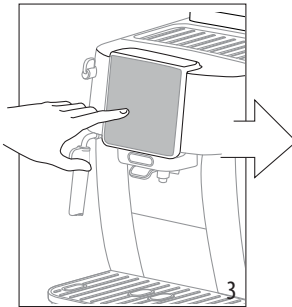
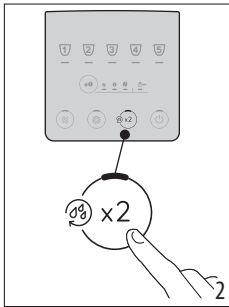
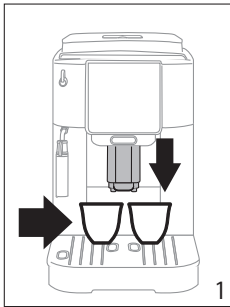
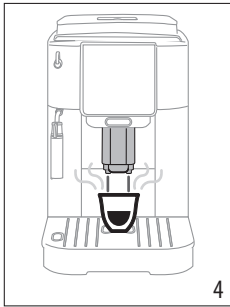

 Espresso

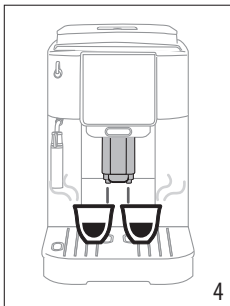

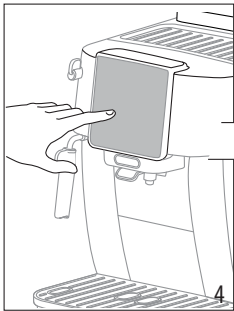
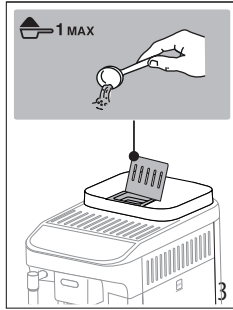
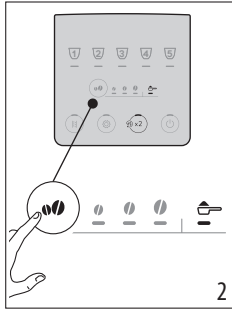
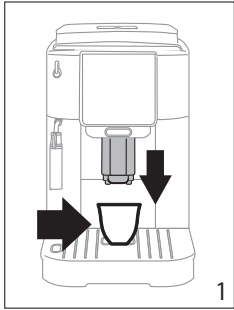

(*)

-  Espresso
-  Coffee
-  Long
-  Americano

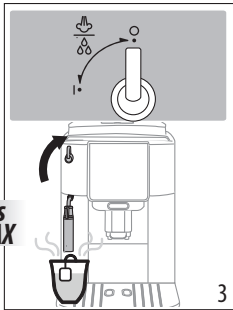
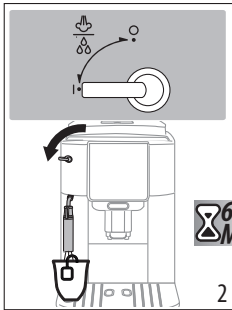
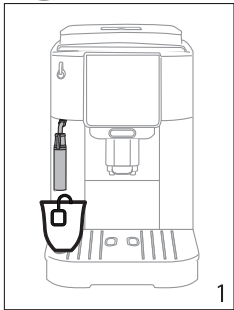
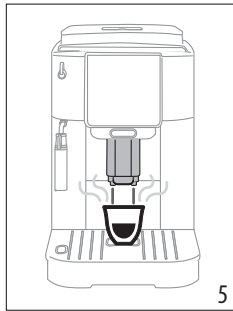

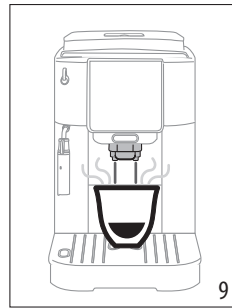
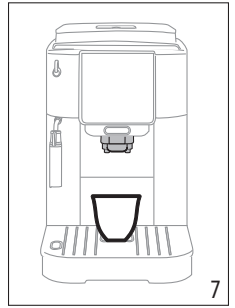
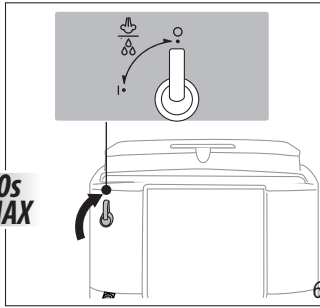
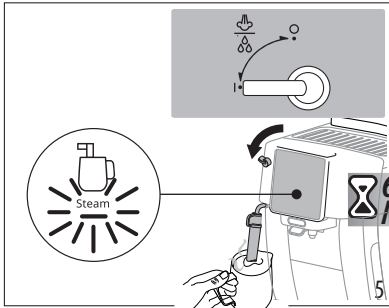
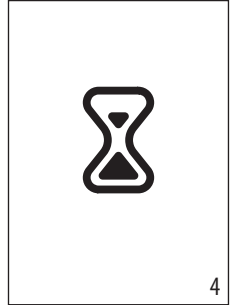
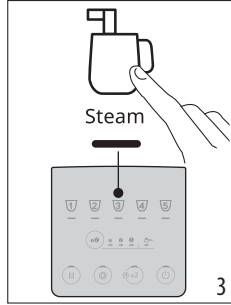
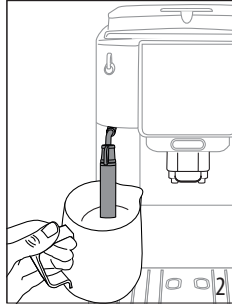
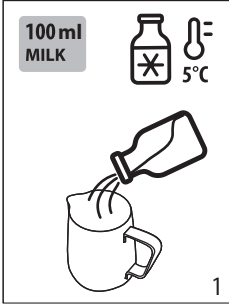



50°C	×	×	×	✓	✓
	✓	✓	✓	✓	✓

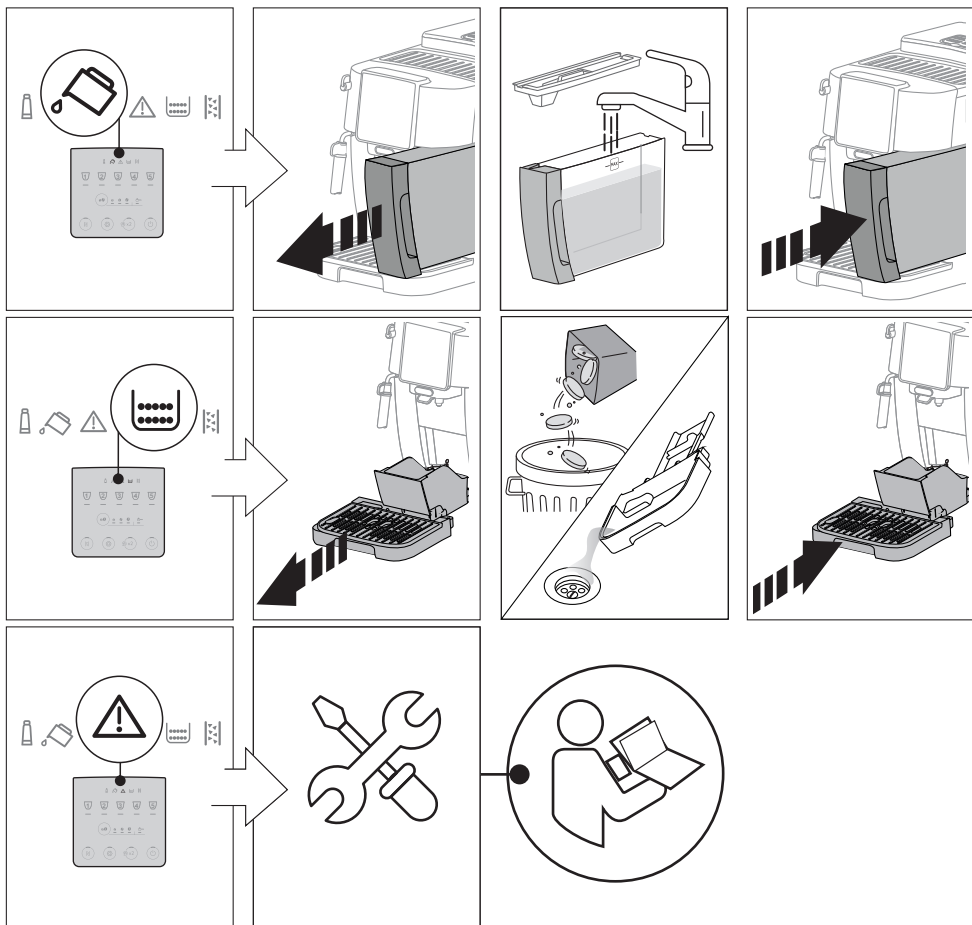

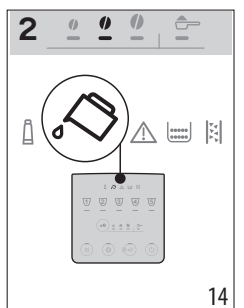
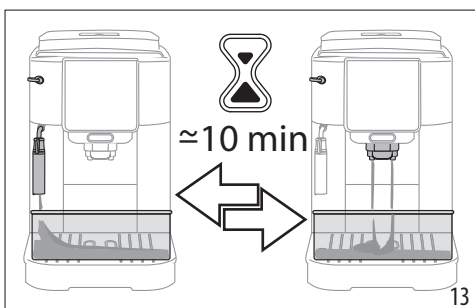
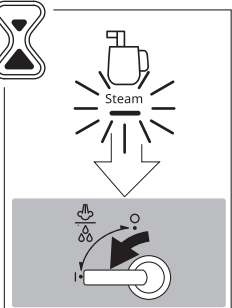
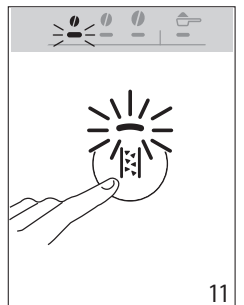
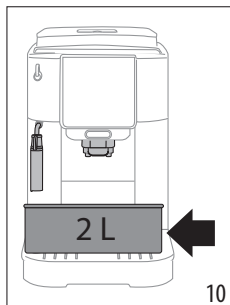
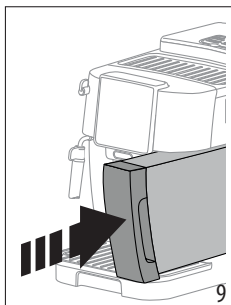
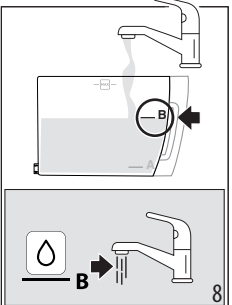
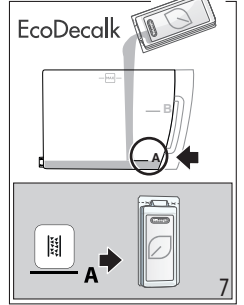
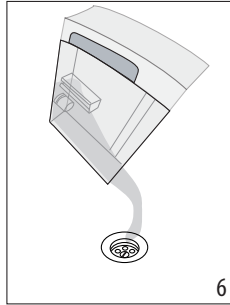
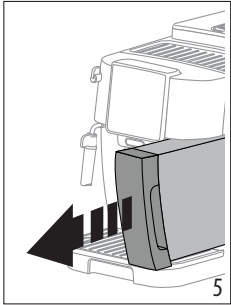
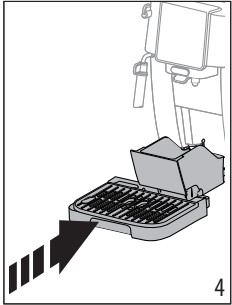
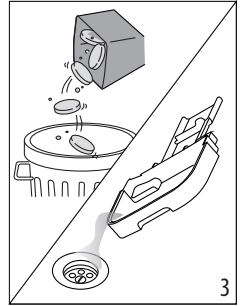
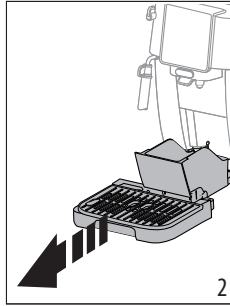
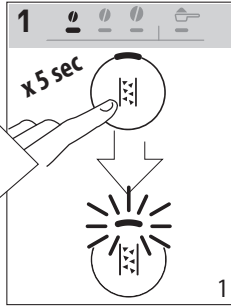
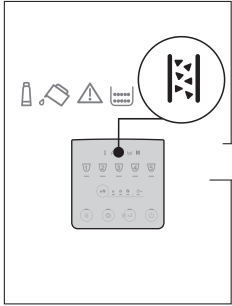

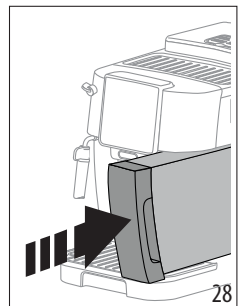
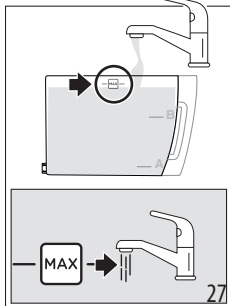
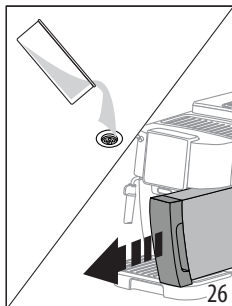
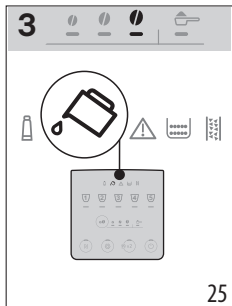
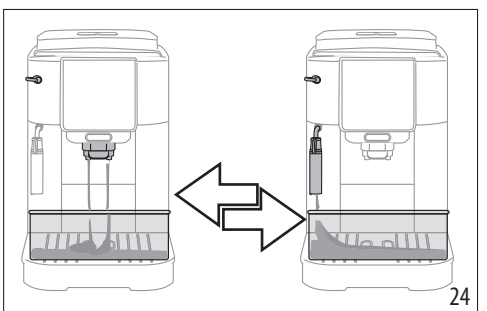
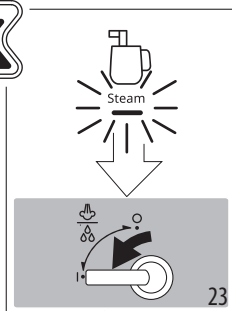
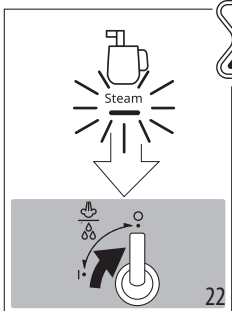
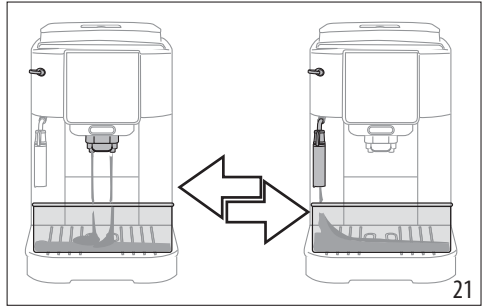
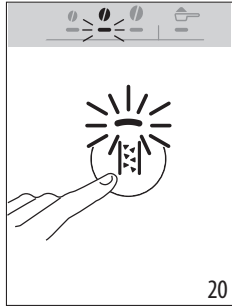
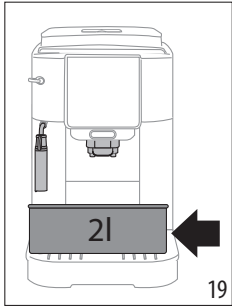
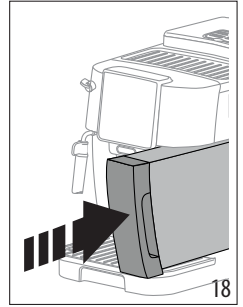
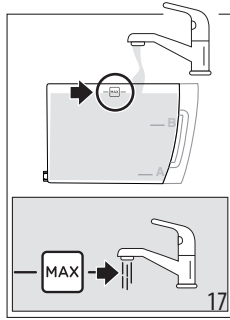
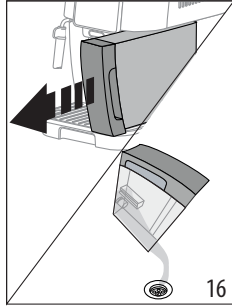
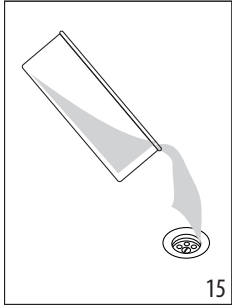

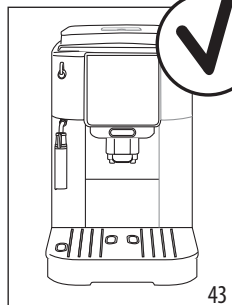
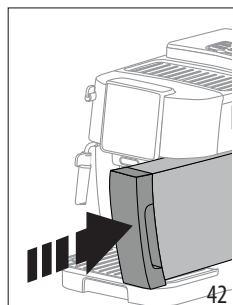
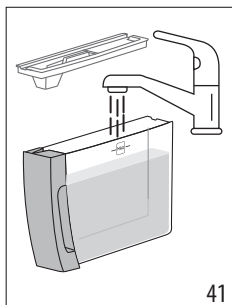
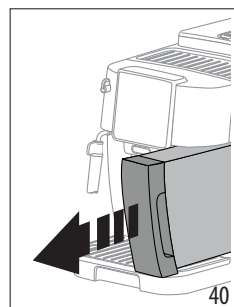
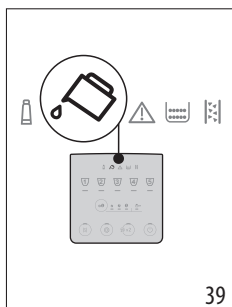
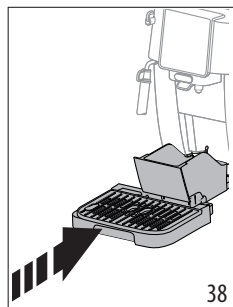
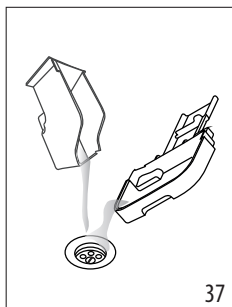
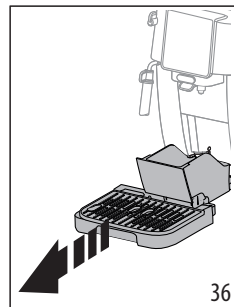
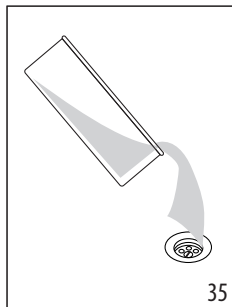
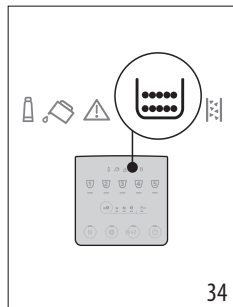
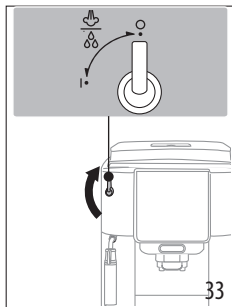
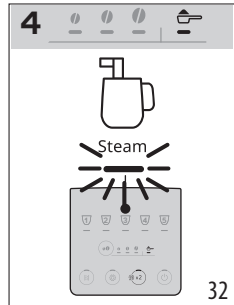
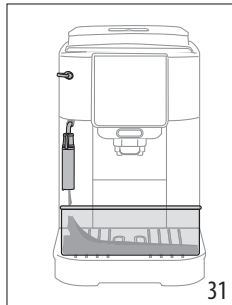
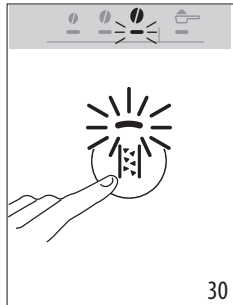
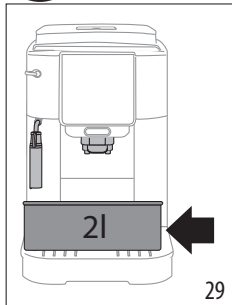

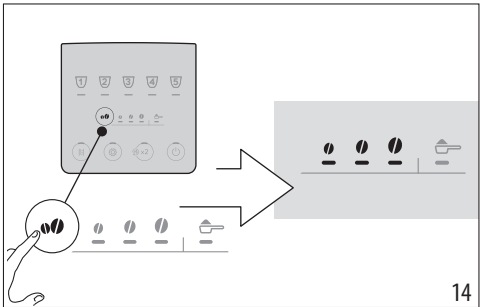
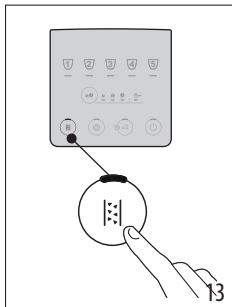
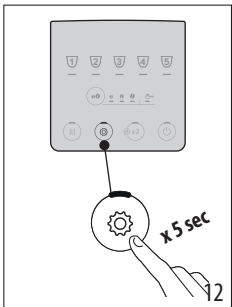
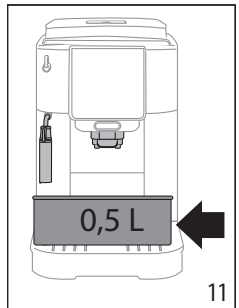
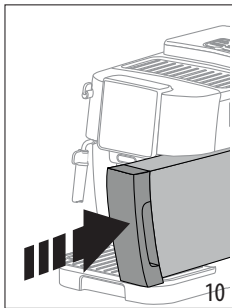
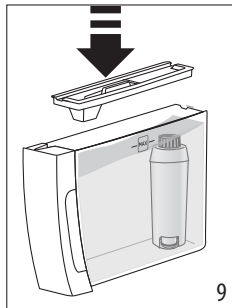
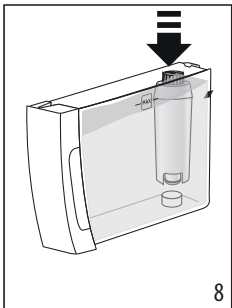
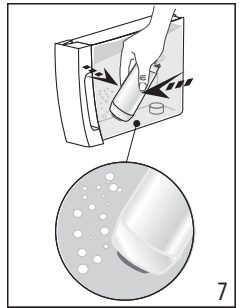
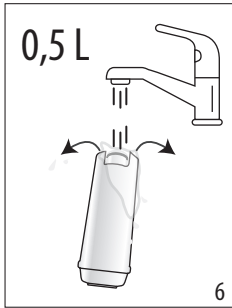
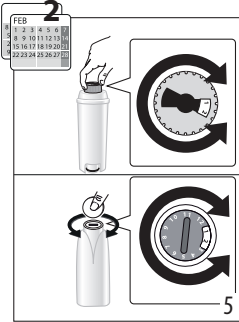
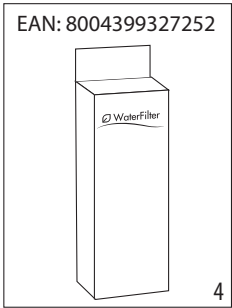
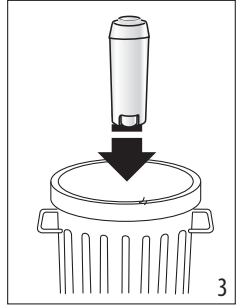
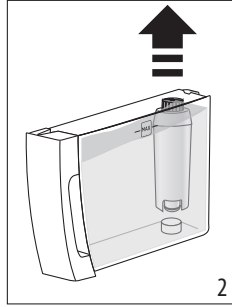
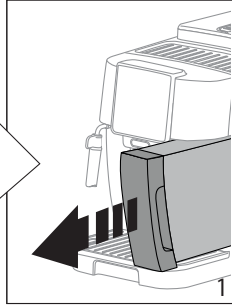
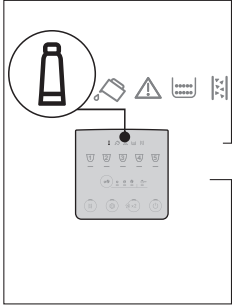

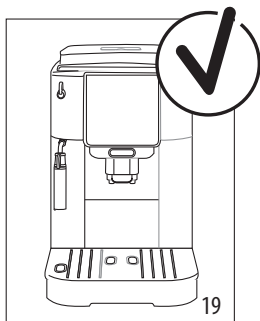
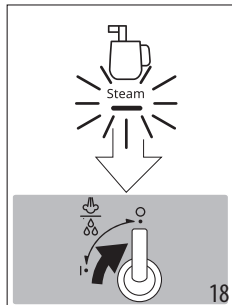
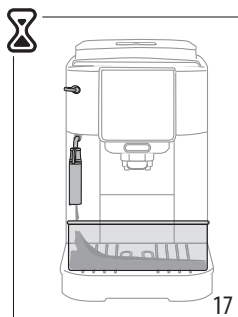
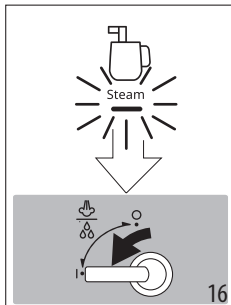
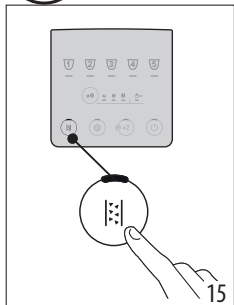

~ 220-240 V 50-60 Hz 1450 W

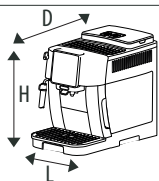

(LxDxH): 240 x 440 x 350 mm

8,8 Kg



More instructions available here



Register Now 
www.delonghi.com/register

