

ECAM22.32X

BEAN TO CUP ESPRESSO
AND CAPPUCCINO
MACHINE
Instruction for use

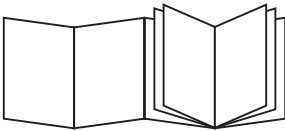

De'Longhi



B

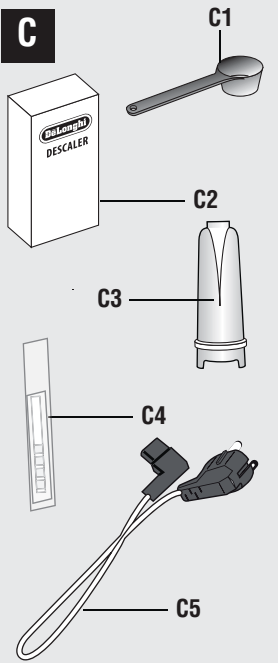
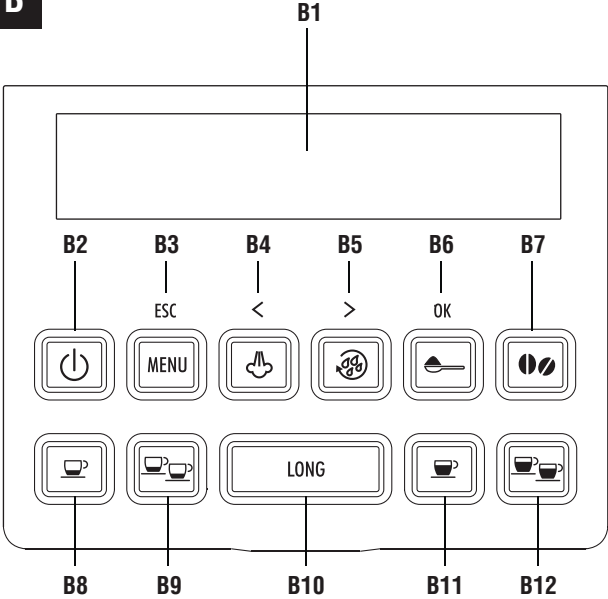

A

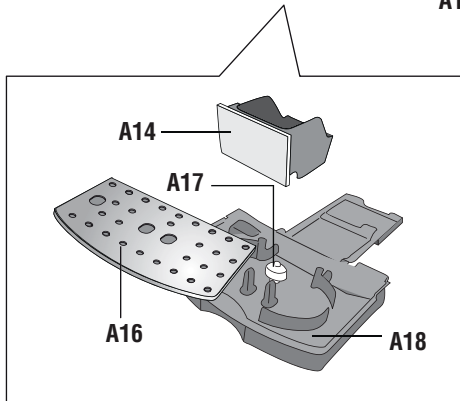
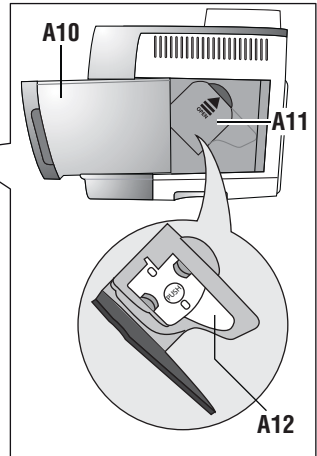
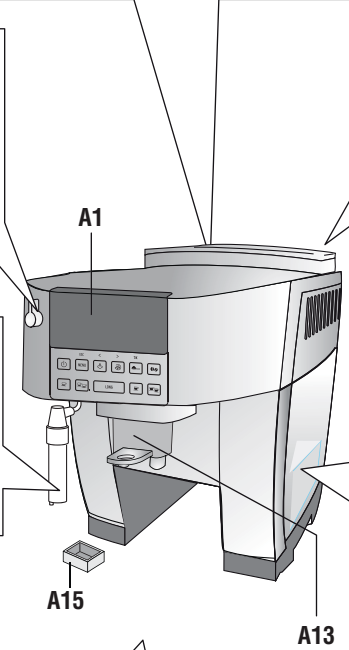
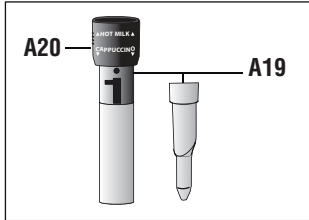
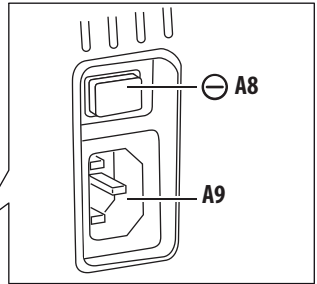
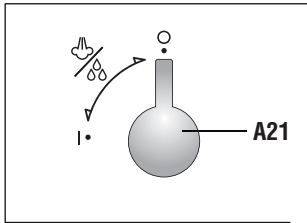
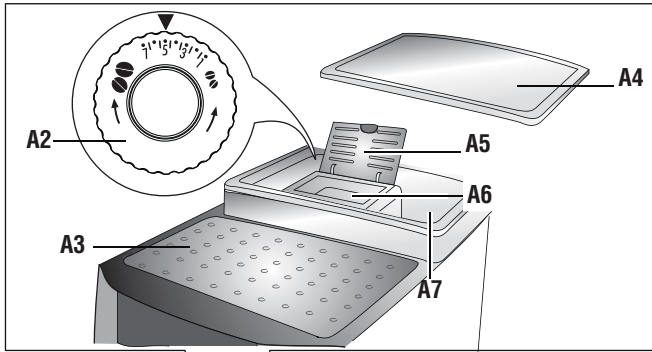

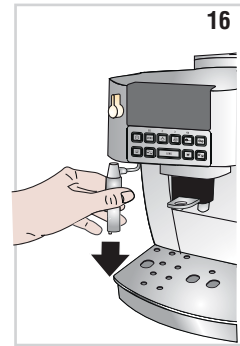
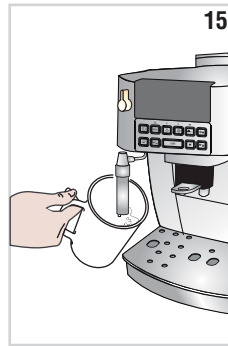
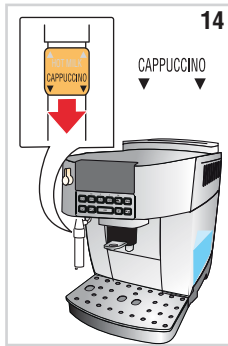
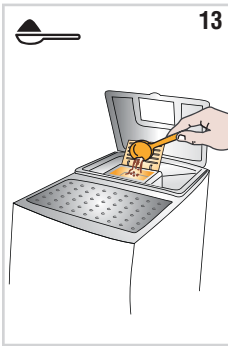
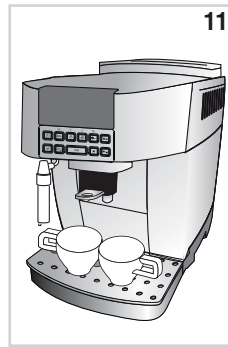
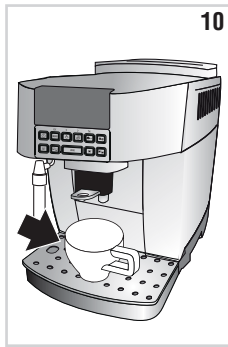
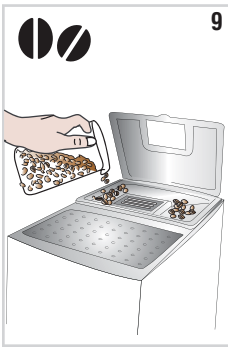
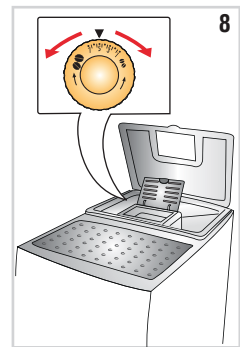
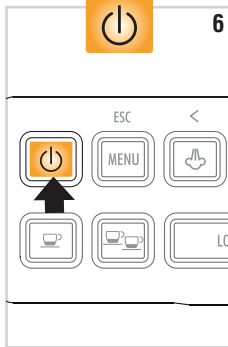
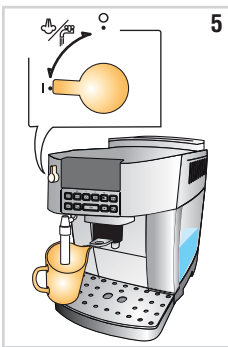
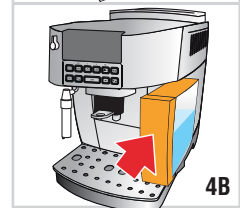
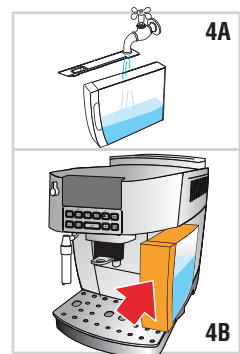
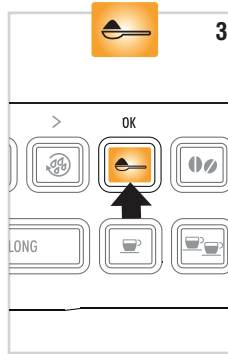
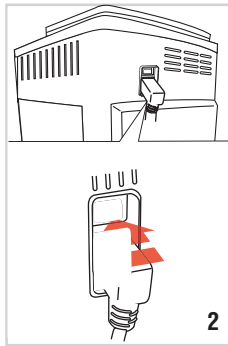
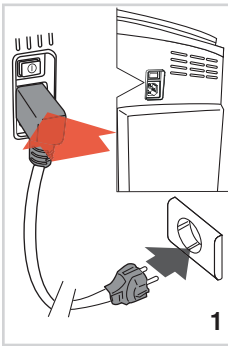

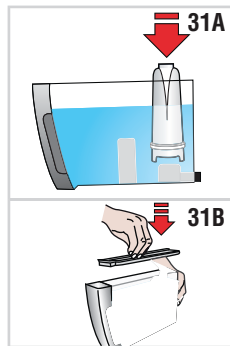
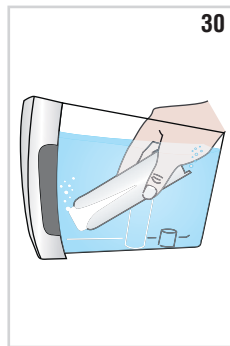
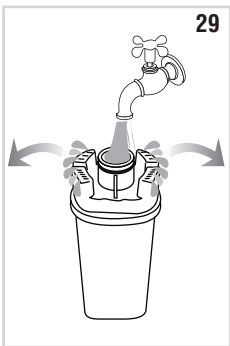
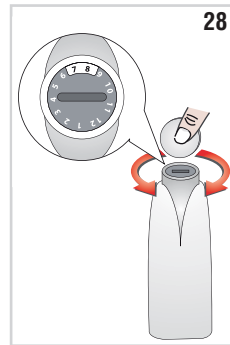
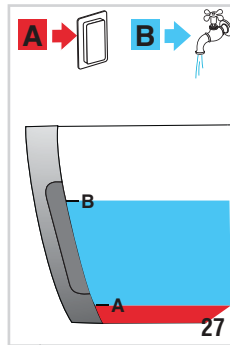
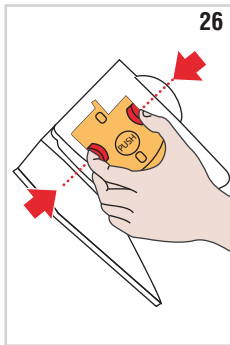
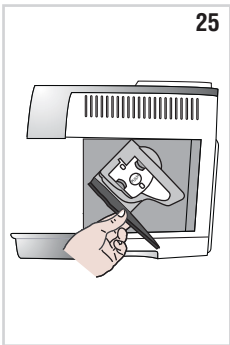
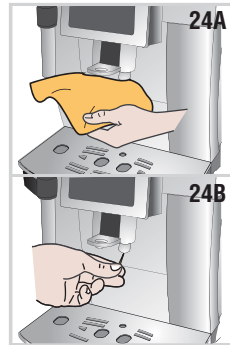
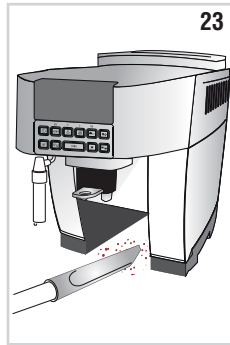
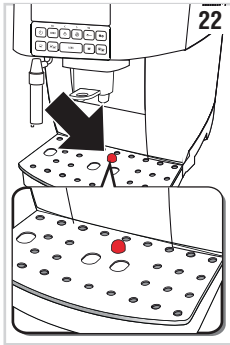
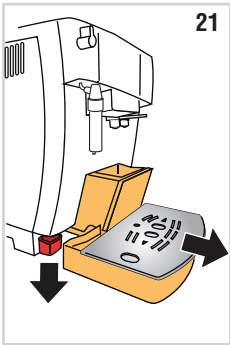
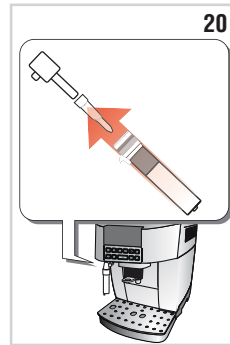
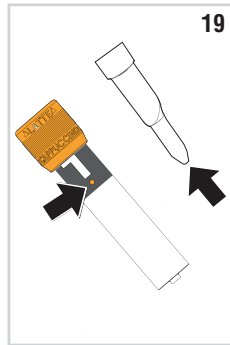
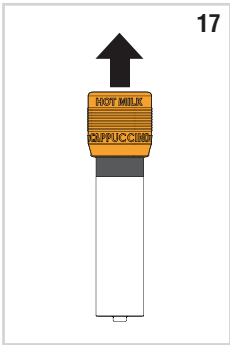

CONTENTS

INTRODUCTION	7
Symbols used in these instructions	7
Letters in brackets	7
Troubleshooting and repairs	7
SAFETY	7
Fundamental safety warnings	7
Designated use	8
Instruction for Use.....	8
DESCRIPTION	8
Description of the appliance	8
Description of the control panel	8
Description of the accessories	8
BEFORE USE	8
Checking the appliance	8
Installing the appliance	8
Setting up the appliance.....	9
TURNING THE APPLIANCE ON.....	9
TURNING THE APPLIANCE OFF	9
MENU SETTINGS	9
Descale	9
Adjust time	10
Auto-off	10
Auto-start	10
Setting the temperature	10
Energy saving.....	10
Setting water hardness	10
Setting the language	10
Install filter	10
Replacing the filter	10
Default values (reset).....	11
Statistics function	11
MAKING COFFEE	11
Selecting the coffee taste	11
Selecting the quantity of coffee in the cup.....	11
Adjusting the grinder.....	11
Tips for a hotter coffee	11
Making coffee using coffee beans	11
Making coffee using pre-ground coffee	12
MAKING LONG COFFEE	12
MAKING CAPPUCCINO AND HOT MILK (NOT FROTHED)	12
Making hot milk (not frothed)	13
Cleaning the cappuccino maker after use.....	13
MAKING HOT WATER	13
CLEANING	13
Cleaning the machine.....	13
Cleaning the coffee grounds container.....	13
Cleaning the drip tray and condensate tray.....	13
Cleaning the inside of the coffee machine	14
Cleaning the water tank.....	14
Cleaning the coffee spouts.....	14
Cleaning the pre-ground coffee funnel.....	14
Cleaning the infuser.....	14
DESCALING	14
SETTING WATER HARDNESS	15
Measuring water hardness.....	15
Set water hardness	15
WATER SOFTENER FILTER	15
Installing the filter	15
Replacing the filter	16
Removing the filter.....	16
TECHNICAL DATA	16
DISPOSAL	16
MESSAGES DISPLAYED	17
TROUBLESHOOTING	18
ELECTRICAL CONNECTION (UK ONLY)	19

INTRODUCTION

Thank you for choosing this automatic espresso and cappuccino machine.

We hope you enjoy using your new appliance.

Take a few minutes to read this Instruction for Use.

This will avoid all risks and damage to the appliance.

Symbols used in these instructions

Important warnings are identified by these symbols.

It is vital to respect these warnings.



Danger!

Failure to observe the warning may result in life threatening injury by electric shock.



Important!

Failure to observe the warning could result in injury or damage to the appliance.



Danger of burns!

Failure to observe the warning could result in burns or scalding.



Please note:

This symbol identifies important advice or information for the user.

Letters in brackets

The letters in brackets refer to the legend in the Description of the Appliance on pages 2 and 3.

Troubleshooting and repairs

In the event of problems, first try and resolve them following the information given in the sections "Displayed messages" on page 17 and "Troubleshooting" on page 18.

If this does not resolve the problem or you require further information, you should consult Customer Services by calling the number given on the annexed "Customer Service" sheet.

If your country is not among those listed on the sheet, call the number given in the guarantee.

If repairs are required, contact De'Longhi Customer Services only.

The addresses are given in the guarantee certificate provided with the machine.

SAFETY

Fundamental safety warnings



Danger!

This is an electrical appliance and may cause electric shock.

You should therefore follow these safety warnings:

- Never touch the appliance with damp hands or feet.
- Never touch the plug with damp hands.

- Make sure the socket used is freely accessible at all times, enabling the appliance to be unplugged when necessary.
- Unplug directly from the plug only.
Never pull the power cable as you could damage it.
- To disconnect the appliance completely, unplug it from the mains socket.
- If the appliance is faulty, do not attempt to repair. Turn it off, unplug from the mains socket and contact Customer Services.

If the plug or power cable is damaged, it must be replaced by De'Longhi Customer Services only to avoid all risk.

Never immerse the appliance in water when cleaning. It is an electrical appliance.

- Before cleaning the outside of the appliance, turn it off, unplug from the mains socket and allow to cool.



Important:

Keep all packaging (plastic bags, polystyrene foam) away from children.

This appliance can be used by children aged from 8 years and above and persons with reduced physical, sensory or mental capabilities or lack of experience and knowledge if they

have been given supervision or instruction concerning use of the appliance in a safe way and understand the hazards involved.

Children shall not play with the appliance.

Cleaning and user maintenance shall not be made by children without supervision.



Danger of burns!

This appliance produces hot water and steam may form while it is in operation.

Avoid contact with splashes of water or hot steam.

When the appliance is in operation, do not touch the cup warmer shelf, as it is hot.



Surfaces marked with this symbol become hot during use (the symbol is present on certain models only).

Designated use

This appliance is designed and made to prepare coffee and heat drinks.

This is a household appliance only.

It is not intended to be used in:

- staff kitchen areas in shops, offices and other working environments;
- farm houses;
- by clients in hotels, motels and other residential type environments;
- bed and breakfast type environments.

Any other use is considered improper and thus dangerous.

The manufacturer is not liable for damage deriving from improper use of the appliance.

Instruction for Use

Read these instructions carefully before using the appliance. Failure to respect these instructions may result in burns or damage to the appliance.

The manufacturer is not liable for damage deriving from failure to respect this Instruction for Use.



Please note:

Keep this Instruction for Use.

If the appliance is passed to other persons, they must also be provided with this Instruction for Use.

DESCRIPTION

Description of the appliance

(page 3 - A)

- A1 Control panel
- A2 Grinding dial
- A3 Cup shelf
- A4 Beans container lid
- A5 Pre-ground coffee funnel lid
- A6 Pre-ground coffee funnel
- A7 Beans container
- A8 Main switch
- A9 Socket for power cable connector
- A10 Water tank
- A11 Infuser door
- A12 Infuser
- A13 Coffee spout (adjustable height)
- A14 Coffee grounds container
- A15 Condensate tray
- A16 Cup rest
- A17 Drip tray water level indicator
- A18 Drip tray

A19 Cappuccino maker

A20 Cappuccino/hot milk ring

A21 Steam/hot water knob

Description of the control panel

(page 2 - B)

A number of buttons on the panel have a dual function. This is indicated in brackets in the description.

- B1. Display: guides the user in using the appliance
- B2. button : turns the appliance on and off
- B3. **MENU** button to access the menu (When in the settings MENU this button functions as an ESC button to exit the function selected and go back to the main menu)
- B4. button to deliver steam to make hot milk-based drinks
(Quando si accede al MENU' programmazione, ha la funzione di <: si preme per scorrere indietro)
- B5. button : to perform a rinse cycle.
(When in the settings MENU this button functions as a > button to scroll forward)
- B6. button : to make coffee using pre-ground coffee.
(When in the settings MENU this button functions as an OK button to confirm selection made)
- B7. Aroma selection button : press to select coffee taste
- B8. button : to make 1 cup of short espresso coffee
- B9. button : to make 2 cups of short espresso coffee
- B10. **LONG** button : to make 1 cup of LONG coffee
- B11. button : to make 1 cup of long espresso coffee
- B12. button : to make 2 cups of long espresso coffee

Description of the accessories

(page 2 - C)

- C1. Measure
- C2. Descaler
- C3. Water softener filter (certain models only)
- C4. Total Hardness Test indicator paper
- C5. Power cable

BEFORE USE

Checking the appliance

After removing the packaging, make sure the product is complete and undamaged and that all accessories are present.

Do not use the appliance if it is visibly damaged. Contact De'Longhi Customer Services .

Installing the appliance



Important!

When you install the appliance, you should observe the following safety warnings:

- The appliance gives off heat. After positioning the

appliance on the worktop, leave a space of at least 3 cm between the surfaces of the appliance and the side and rear walls and at least 15 cm above the coffee machine.

- Water penetrating the appliance could cause damage. Do not place the appliance near taps or sinks.
- The appliance could be damaged if the water inside it freezes. Do not install the appliance in a room where the temperature could drop below freezing point.
- Arrange the power cable in such a way that it cannot be damaged by sharp edges or contact with hot surfaces (e.g. electrical hot plates).

Setting up the appliance



Please note :

- Coffee has been used to factory test the appliance and it is therefore completely normal for there to be traces of coffee in the grinder. The machine is, however, guaranteed to be new.
 - You should customise water hardness as soon as possible following the instructions in the section “Setting water hardness” (page 15).
1. Insert the power cable connector in socket at the back of the appliance and connect the appliance to the mains electricity supply (fig. 1). Make sure the main switch at the back of the appliance is pressed down (fig. 2).

You must choose the language (the languages scroll through at intervals of about 3 seconds):

2. when English appears press the  button for a few seconds (fig. 3) until the display shows “ENGLISH set”.

Then follow the instructions indicated on the display:

3. “FILL TANK” : remove the water tank, fill to the MAX line with fresh water (fig. 4A) then insert back into the appliance (fig. 4B).
4. Place a container with a minimum capacity of 100 ml under the cappuccino maker (fig. 5).
5. “TURN STEAM KNOB”: turn the steam knob to the I position (fig. 5). “HOT WATER Confirm?” appears on the display;
6. To confirm press  : the appliance delivers hot water from the cappuccino maker and then turns off automatically.
7. Turn the steam knob to the “0” position.

The coffee machine is now ready for normal use.



Please note :

- When setting up the appliance, you need to make 4-5 cups of coffee or 4-5 cappuccinos before the appliance starts to give satisfactory results.

TURNING THE APPLIANCE ON



Please note :

Before turning the appliance on, make sure the main switch at the back of the appliance is pressed down (fig. 2).

Each time the appliance is turned on, it performs an automatic preheat and rinse cycle which cannot be interrupted.

The appliance is ready for use only once this cycle is complete.



Danger of scalding!

During rinsing, a little hot water comes out of the coffee spouts and is collected in the drip tray underneath. Avoid contact with splashes of water.

- Press the  button to turn on the appliance (fig. 6). The message “Heating up Please wait” is displayed.

When the heating up is complete, the message changes to “Rinsing”. By circulating hot water, the appliance heats both the boiler and the internal circuits.

The appliance is at temperature when the message indicating the taste and quantity of coffee is displayed.

TURNING THE APPLIANCE OFF

Each time the appliance is turned off, it performs an automatic rinse cycle which cannot be interrupted.



Danger of scalding!

During rinsing, a little hot water comes out of the coffee spouts. Avoid contact with splashes of water.

To turn the appliance off, press the  button (fig. 6). The appliance performs a rinse cycle then turns off (stand-by).



Please note:

If you will not be using the appliance for some time, unplug it from the mains socket:

- first turn the appliance off by pressing the  button (fig. 6);
- press the main switch (fig. 2).



Important!

Never press the main switch while the appliance is switched on.

MENU SETTINGS









When you access the settings menu by pressing the MENU button, the following menu items can be selected: Descale, Adjust time, Auto-off, Auto-start, Set temperature, Energy saving, Water hardness, Set language, Install filter, Replace filter, Default values, Statistics..

Descale

For instructions on descaling, see page 14.

Adjust time







To adjust the time on the display, proceed as follows:

1. Press the **MENU** button to access the menu;
2. Press the  or  button until "Adjust time" is displayed;
3. Press the button ;
4. Press the  or  button to change the hour;
5. Press the  button to confirm;
6. Press the  or  button to change the minutes;
7. Press the  button to confirm.

The time is set: press **MENU** to exit menu.

Auto-off

Auto-off can be set so that the appliance turns off after 15 or 30 minutes, or after 1, 2 or 3 hours.

1. Press the **MENU** button to access the menu;
2. Press the  or  button until "Auto-off" is displayed;
3. Press the button ;
4. Press the  or  until the number of minutes/hours of operation is displayed (15 or 30 minutes, or 1, 2 or 3 hours);
5. Press the  button to confirm.

The auto-off is set. Press **MENU** to exit menu.











Auto-start

You can set the auto-start time in order to have the appliance ready for use at a certain time (for example in the morning) so you can make coffee immediately.





Please note:

To enable this function you must ensure the time is set correctly.

1. Press the **MENU** button to access the menu;
2. Press the  or  button until "Auto-start" is displayed;
3. Press the  button and "Enable?" is displayed;
4. Press the  button to confirm;
5. Press the  or  button to choose the hour;
6. Press the  button to confirm;
7. Press the  or  button to change the minutes;
8. Press the  button to confirm;
9. Then press **MENU** to exit menu.

Once the time has been confirmed, activation of auto-start is indicated by the symbol  which is displayed alongside the time and under the Auto-start item in the menu.







To disable the function:

1. Select auto-start from the menu;
2. Press the  button and "Disable?" is displayed;
3. Press the  button to confirm.

The symbol  is no longer displayed.

Setting the temperature





If you want to modify the temperature of the water used to make the coffee (low, medium, high), proceed as follows:

1. Press the **MENU** button to access the menu;
2. Press the  or  button until "Set temperature" is displayed;
3. Press the button ;
4. Press the  or  button until the required temperature is displayed (low, medium, high);
5. Press the  button to confirm.

The temperature is set. Press **MENU** to exit menu.

Energy saving

Use this function to enable or disable Energy Saving. When enabled, the function reduces energy consumption in compliance with EU regulations. When energy saving mode is enabled an asterisk appears under "Energy saving" in the menu.

1. Press the **MENU** button to access the menu;
2. Press the  or  button until "Energy saving" is displayed;
3. Press the  button and "Enable?" or "Disable?" is displayed;
4. Press the  button to enable or disable the energy saving mode;

Then press **MENU** to exit menu.

When the function is enabled, if the machine is not used for about 1 minute "Energy saving" is displayed.



Please note:







When in energy saving mode, a few seconds may elapse before the first coffee is delivered as the appliance must heat up again.

Setting water hardness

For instructions on setting water hardness, see page 15.

Setting the language

To change the language on the display, proceed as follows:

1. Press the **MENU** button to access the menu;
2. Press the  or  button until "Set language" is displayed;
3. Press the button ;
4. Press the  or  button until the required language is displayed;
5. Press the  button to confirm;

The language is set. Press **MENU** to exit menu.

Install filter





For instructions on installing the filter, see section on "Installing the filter" (page 15).

Replacing the filter

For instructions on replacing the filter, see section on "Replacing the filter" (page 10).







Default values (reset)

This resets all menu settings and programmed quantities back to the default values (with the exception of the language which remains as set).

1. Press the MENU button to access the menu;
2. Press the  or  button until "Default values" is displayed;
3. Press the button ;
4. The message "Confirm?" appears on the display;
5. Press the  button to confirm and exit.

Statistics function

This displays statistics relating to the machine. To display, proceed as follows:

1. Press the MENU button to access the menu;
2. Press the  or  button until "Statistics" is displayed;
3. Press the button ;
4. By pressing the  or  button you can check:
 - how many coffees have been made;
 - how many times the machine has been descaled;
 - the total number of litres of water delivered;
 - how many times the water filter has been replaced.
5. Then press the  button twice to exit menu.

MAKING COFFEE

Selecting the coffee taste

The appliance is set by default to make coffee with a standard taste.





You can also choose one of these tastes:

- Extra-mild taste
- Mild taste
- Standard taste
- Strong taste
- Extra-strong taste

To change the taste, press the  button repeatedly (fig. 7) until the required taste is displayed.

Selecting the quantity of coffee in the cup

The appliance is set by default to automatically make the following quantities of coffee:

- short espresso coffee, when the  button is pressed (≈40ml);
- long espresso coffee when the  button is pressed (≈120ml);
- two short espresso coffees when the  button is pressed;
- two long espresso coffees when the  button is pressed.

To change the quantity of coffee the appliance delivers automatically into the cup, proceed as described below:

- press the button corresponding to the quantity to be modified and hold it down until "Program quantity" is displayed, then release the button;
- when the coffee in the cup reaches the desired level, press the same button again to memorise the new amount.

The machine is now reprogrammed with the new quantities.

Adjusting the grinder

The coffee mill is set by default to prepare coffee correctly and should not require regulating initially.

However, if after making the first few coffees you find that the coffee is either too weak and not creamy enough or delivery is too slow (in drops), this can be corrected by adjusting the grinding dial (fig. 8).

 *Please note :*

The grinding dial must only be turned while the coffee mill is in operation.

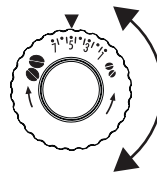

If the coffee is delivered too slowly or not at all, turn one click clockwise.

For fuller bodied creamier coffee, turn one click anticlockwise (do not turn more than one click at a time otherwise the coffee could be delivered in drops).

These adjustments will only be evident after at least 2 cups of coffee have been delivered.

If this adjustment does not obtain the desired result, turn the dial another click.

Tips for a hotter coffee

For hotter coffee, you should:

- before delivering the coffee, perform a rinse cycle by pressing the  button. Hot water is delivered from the spout, heating the internal circuits of the appliance and thus raising the coffee temperature;
- warm the cups by rinsing them with hot water (using the hot water function);
- increase the temperature of the coffee in the menu (page 10).

Making coffee using coffee beans

 *Important!*

Do not use caramelised or candied coffee beans as they could stick to the coffee mill and damage it.

1. Fill the container with coffee beans (fig. 9).
2. Place under the coffee spouts:

- 1 cup, if you want to make 1 coffee (fig. 10);
 - 2 cups, if you want 2 coffees (fig. 11).
3. Lower the spout as close as possible to the cup(s). A creamier coffee is obtained in this way (fig. 12).
 4. Press the button for delivery of the required coffee.



5. Delivery begins and the selected quantity and taste are displayed.

Once the coffee has been made, the appliance is ready to be used again.

i Please note :

- While the machine is making coffee, delivery can be interrupted at any moment by pressing one of the coffee buttons.
- At the end of delivery, to increase the quantity of coffee in the cup, just press and hold (within 3 seconds) one of the coffee buttons.

i Please note :

For hotter coffee, see the section “**Tips for a hotter coffee**”.

! Important!

- If the coffee is delivered in drops, too weak and not creamy enough or too cold, read the tips in the “Troubleshooting” section on page 18.
- Various warning messages could be displayed while the machine is in use. Their meaning is explained in the section “Messages displayed” on page 17.

Making coffee using pre-ground coffee

! Important!

- Never place coffee beans in the pre-ground coffee funnel as this could damage the appliance.
- Never add pre-ground coffee when the machine is turned off or it could spread through the inside of the appliance and dirty it. This could damage the appliance.
- Never use more than 1 level measure or it could dirty the inside of the appliance or block the funnel.



i Please note :

If you use pre-ground coffee, you can only make one cup of coffee at a time.

1. Make sure the appliance is turned on.
2. Press the ☞ button.

3. Make sure the funnel is not blocked, and then add one level measure of pre-ground coffee (fig. 13).
4. Place a cup under the coffee spouts.
5. Press the 1 cup ☞ or ☞ button.
6. Delivery begins.

MAKING LONG COFFEE

LONG coffee can be made using either coffee beans or pre-ground coffee.

Follow the directions above to prepare the machine and press the **LONG** button.

MAKING CAPPUCCINO AND HOT MILK (NOT FROTHED)

! Danger of scalding!

Be careful of scalding as steam escapes during preparation of these drinks.

1. When preparing cappuccino, make the coffee in a large cup;
2. Fill a container with about 100 grams of milk for each cappuccino. In choosing the size of the container, bear in mind that the milk will double or triple in volume;

i Please note :

For a richer denser froth, use skimmed or partially skimmed milk at refrigerator temperature (about 5°C). To avoid milk with poor froth or large bubbles, always clean the cappuccino maker as described in the section “Cleaning the cappuccino maker after use”.

3. Make sure the cappuccino/hot milk ring is positioned downwards in the CAPPUCCINO position (fig. 14);
4. Press the ☞ button. “Heating up Please wait” is displayed, followed after a few seconds by “TURN STEAM KNOB”;
5. Turn the cappuccino maker outwards and immerse it in the milk container (fig. 15). Take care not to immerse the black ring;
6. Turn the steam knob to the I position (fig. 5). Steam is delivered from the cappuccino maker, giving the milk a creamy frothy appearance and making it more voluminous;
7. For a creamier froth, rotate the container with slow movements in an upward direction. (You should not discharge steam for more than 3 minutes at a time);
8. When you have obtained the required froth, stop steam delivery by turning the steam knob back to the 0 position.

! Danger of scalding!

Stop steam delivery before removing the container with the frothed milk to avoid burns caused by splashes of boiling milk.

9. Add the milk froth to the cup of coffee prepared previously. The cappuccino is ready. Sweeten to taste and, if desired, sprinkle the froth with a little cocoa powder.

Making hot milk (not frothed)

To make hot milk without froth, proceed as described in the above section, making sure the cappuccino/hot milk ring of the cappuccino maker is positioned upwards in the "HOT MILK" position.

Cleaning the cappuccino maker after use

Clean the cappuccino maker each time you use it to avoid the build-up of milk residues or blockages.



Danger of scalding!

When cleaning the cappuccino maker, a little hot water is delivered. Avoid contact with splashes of water.

1. Let a little water run for a few seconds by rotating the steam knob to the I position. Then turn the steam knob to the 0 position to stop the flow of hot water.
2. Wait a few minutes for the cappuccino maker to cool down. To remove the cappuccino maker turn it outwards and slide it down (fig. 16).
3. Move the cappuccino/hot milk ring upwards (fig. 17).
4. Slide the nozzle downwards (fig. 18).
5. Make sure the two holes shown by the arrows in fig. 19 are not blocked. If necessary, clean with a pin.
6. Replace the nozzle, move the ring downwards and put the cappuccino maker back on the nozzle (fig. 20), turning it and pushing it upwards until it is attached.

MAKING HOT WATER



Danger of scalding!

Never leave the machine unsupervised while hot water is being delivered. As shown below, stop delivery of hot water when the cup is full.

The cappuccino maker becomes hot while hot water is being delivered and must be held by the black ring only.

1. Place a container under the cappuccino maker (as close as possible to avoid splashes) (fig. 15).
2. Turn the steam knob to the I position (fig. 5). "HOT WATER" is displayed and delivery begins.
3. Stop by turning the steam knob to the 0 position.



Please note :

If "Energy Saving" mode is active, you may have to wait a few seconds before the hot water is delivered.

CLEANING

Cleaning the machine

The following parts of the machine must be cleaned regularly:

- coffee grounds container (A14),
- drip tray (A18) and condensate tray (A15),
- water tank (A10),
- coffee spouts (A13),
- pre-ground coffee funnel (A6),
- inside of the machine, accessible after opening the infuser door (A11),
- infuser (A12).



Important!

- Do not use solvents, abrasive detergents or alcohol to clean the machine. You do not need to use chemical products to clean De'Longhi superautomatic coffee machines.
- None of the components can be washed in a dishwasher.
- Do not use metal objects to remove encrustations or coffee deposits as they could scratch metal or plastic surfaces.

Cleaning the coffee grounds container

When "EMPTY GROUNDS CONTAINER" is displayed, the grounds container must be emptied and cleaned.

Unless you clean the grounds container, the above message will continue to be displayed and the appliance cannot be used to make coffee. To clean (with the machine turned on):

- Remove the drip tray (fig. 21), empty and clean.
- Empty the grounds container and clean thoroughly to remove all residues left on the bottom.
- Check the red condensate tray and empty if necessary.



Important!

When removing the drip tray, the grounds container must be emptied, even if it contains few grounds.

If this is not done, when you make the next coffees, the grounds container may fill up more than expected and clog the machine.

Cleaning the drip tray and condensate tray



Important!

If the drip tray is not emptied regularly, the water could overflow and seep inside or around the machine.

This could damage the machine, the surface it rests on or the surrounding area.

The drip tray is fitted with a floating level indicator (red) showing the level of water it contains (fig. 22).

Before the indicator protrudes from the cup rest, the drip tray must be emptied and cleaned.

To remove the drip tray:

1. Remove the drip tray and the grounds container (fig. 21);
2. Empty the drip tray and grounds container and wash them;
3. Check the red condensate tray and empty if necessary.
4. Replace the drip tray and grounds container.

Cleaning the inside of the coffee machine



Before cleaning internal parts, the machine must be turned off (see "Turning off") and unplugged from the mains power supply. Never immerse the machine in water.

1. Check regularly (about once a month) that the inside of the appliance (accessible after removing the drip tray) is not dirty. If necessary, remove coffee deposits with a brush and a sponge.
2. Remove the residues with a vacuum cleaner (fig. 23).

Cleaning the water tank

1. Clean the water tank (A9) regularly (about once a month) and each time you replace the water softener filter (if provided) with a damp cloth and a little mild washing up liquid.
2. Remove the filter (if present) and rinse with running water.
3. Replace the filter (if provided), fill the tank with fresh water and replace the tank.

Cleaning the coffee spouts

1. Clean the coffee spouts with a sponge or cloth (fig. 24A).
2. Check the holes in the coffee spout are not blocked. If necessary, remove coffee deposits with a toothpick (fig. 24B).

Cleaning the pre-ground coffee funnel

Check regularly (about once a month) that the pre-ground coffee funnel (A6) is not blocked.

If necessary, remove coffee deposits with a brush.

Cleaning the infuser

The infuser (A12) must be cleaned at least once a month.



The infuser may not be extracted when the machine is on.

1. Make sure the machine is correctly turned off (see "Turning off" on page 9).
2. Remove the water tank.
3. Open the infuser door (fig. 25) positioned on the right side of the machine.
4. Press the 2 red release buttons inwards and at the same time pull the infuser outwards (fig. 26).



RINSE WITH WATER ONLY

NO WASHING UP LIQUID - NO DISHWASHER

Do not use washing up liquid to clean the infuser as it may damage it.

5. Soak the infuser in water for about 5 minutes, then rinse under the tap.
6. Use a brush to remove any coffee residues left in the infuser housing, visible through the infuser door.
7. After cleaning, replace the infuser by sliding it onto the internal support, then push the PUSH symbol fully in until it clicks into place.

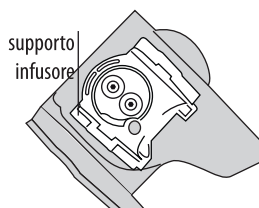

If the infuser is difficult to insert, before insertion, squeeze the two levers shown in the figure to make it smaller.

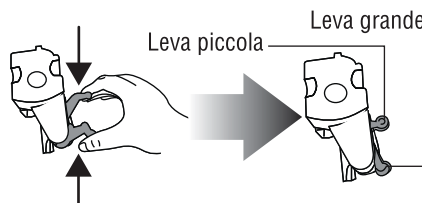

7. Once inserted, make sure the two red buttons have popped out again.

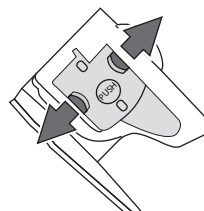

8. Close the infuser door.
9. Replace the water tank.

DESCALING

Descale the machine when the message "DESCALE" flashes on the display.



Descaler contains acids which may irritate the skin and eyes.

It is essential that you observe the manufacturer's safety warnings indicated on the descaler packet and the warnings relating to the procedure to follow in the event of contact with the skin and eyes.



Please note:

Use descaler recommended by De'Longhi only. Failure to descale the appliance as described above also invalidates the guarantee.

1. Turn the coffee machine on.
2. Press the MENU button to access the menu.
3. Press the or button until "Descal" is displayed.
4. Select by pressing the button. The message "Descal Confirm?" appears on the display. Press again to enable the function.
5. "Add descaler Confirm?" appears on the display.
6. Empty the water tank (A10) completely and remove the water softener filter (if present).
7. Pour the descaler into the tank up to the level **A** (equal to one 100ml packet) marked on the back of the tank (fig. 27), then add water (1 litre) up to level **B** (fig. 27).
8. Place an empty container with a minimum capacity of 1.5 litres under the cappuccino maker (A19) (fig. 5).



Danger of scalding!

Hot water containing acid is delivered from the cappuccino maker. Avoid contact with splashes of water.

9. Press the button to confirm that the solution has been introduced. "TURN STEAM KNOB" then appears on the display.
10. Turn the steam knob to the I position (fig. 5). The descaling programme starts and the descaler liquid comes out of the cappuccino maker. The descaling programme automatically performs a series of rinses and pauses to remove all the scale residues inside the coffee machine. After about 30 minutes, the message "FILL TANK!" is displayed. The appliance is now ready for rinsing through with clean water.
11. Empty the container used to collect the descaler solution and replace it empty under the cappuccino maker.
12. Remove the water tank, empty, rinse under running water, fill with clean water and replace. "Rinsing" appears on the display.
13. Hot water comes out of the cappuccino maker.
14. When the water tank is completely empty, "TURN STEAM KNOB" is displayed.
15. Turn the knob to the 0 position, insert the filter in the tank (if present), fill the water tank and the machine is ready for use.

SETTING WATER HARDNESS

The DESCALE message is displayed after a period of operation established according to the water hardness.

The machine is set by default for a hardness value of 4.

The machine can also be programmed according to the hardness of the mains water in the various regions so that the machine needs to be descaled less often.

Measuring water hardness

1. Remove the TOTAL HARDNESS TEST indicator paper attached to this manual from its pack.
2. Immerse the paper completely in a glass of water for about one second.
3. Remove the paper from the water and shake lightly. After about a minute, 1, 2, 3, or 4 red squares form, depending on the hardness of the water. Each square corresponds to one level.

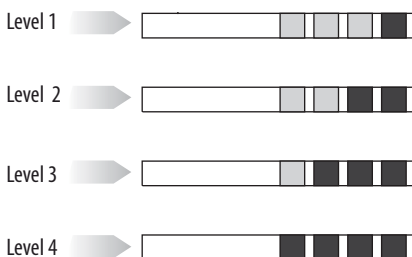

Set water hardness

1. Press the MENU button to access the menu.
2. Press the or button until "Water hardness" is displayed.
3. Press the button to confirm the selection.
4. Press the or button repeatedly to set the level as measured by the indicator paper (see previous section).
5. Press the button to confirm setting.

The machine is now reprogrammed with the new water hardness setting. Press the MENU button again to exit menu.

WATER SOFTENER FILTER

Certain models are fitted with a water softener filter. If this is not the case with your model, you are recommended to purchase one from authorised De'Longhi Customer Services.

To use the filter correctly, follow the instructions below.

Installing the filter





1. Remove the filter from the packaging.
2. Turn the date indicator disk (see fig. 28) until the next two months of use are displayed.

i Please note :

The filter lasts about two months if the appliance is used normally. If the coffee machine is left unused with the filter installed, it will last a maximum of three weeks.

3. To activate the filter run tap water into the hole as indicated in the diagram letting the water run out of the side openings for at least one minute (fig. 29).
4. Take out the tank from the appliance and fill with water.
5. Place the filter in the water tank and submerge it completely for ten seconds, tilting it to enable the air bubbles to escape (fig. 30).
6. Insert the filter into the filter housing and press as far as it will go (fig. 31A).
7. Close the tank with the lid (fig. 31B), and then replace the tank in the machine.



When you install the filter you must notify the appliance of its presence.

8. Press the **MENU** button to access the menu;
9. Press the  or  button repeatedly until "Install filter" is displayed.
10. Press the button .
11. The message "Enable?" appears on the display.
12. Press the  button to confirm selection. "TURN STEAM KNOB" appears on the display.
13. Place a container under the cappuccino maker (min. capacity of 100 ml).
14. Turn the steam knob (fig. 5). "HOT WATER Confirm?" is displayed.
15. Press the  button to confirm selection. The appliance begins hot water delivery and the message "Please wait" is displayed.
16. Once delivery is completed, "TURN STEAM KNOB" is displayed.
17. Turn the steam knob to the 0 position (fig. 5). The appliance automatically resets to "Coffee ready" status.



The filter is now active and indicated by an asterisk displayed in the menu under the item "Install filter". You can now use the coffee machine.

Replacing the filter

When the message "Replace filter" is displayed or after two months (see date indicator) or when the appliance has not been used for 3 weeks, you should replace the filter.

1. Remove the water tank and used up filter;
2. Take the new filter out of its packet and proceed as illustrated in points 3, 4, 5 and 6 in the previous section.
3. Place a container under the cappuccino maker (min. capacity of 100 ml).
4. Press the **MENU** button to access the menu;
5. Press the  or  button repeatedly until "Replace





filter" is displayed.

10. Press the  button;
11. The message "Confirm?" is displayed.
12. Press the  button to confirm selection. "TURN STEAM KNOB" appears on the display;
13. Turn the steam knob. "HOT WATER Confirm?" is displayed.
14. Press the  button to confirm selection. The appliance begins hot water delivery and the message "Please wait" is displayed.
15. Once delivery is completed, "TURN STEAM KNOB" appears on the display. Turn the steam knob to the 0 position. The appliance automatically resets to "Coffee ready" status.

The new filter is now active and you can use the coffee machine.

Removing the filter

If you want to continue use the appliance without the filter, you must remove it and notify the appliance of its removal. Proceed as follows:

1. Remove the water tank and used up filter;
2. Press the **MENU** button to access the menu;
3. Press the  or  button repeatedly until "Install filter" is displayed.
4. Press the button  ;
5. The message "Disable?" appears on the display;
6. Press the  button to confirm and the MENU button to exit the menu.

TECHNICAL DATA

Voltage:	220-240 V ~ 50/60 Hz max. 10A
Absorbed power:	1450W
Pressure:	15 bar
Max. capacity water tank:	1,8 litres
Size: LxHxD:	238x345x430 mm
Cable length:	1,15 m
Weight:	9,1 Kg
Max. capacity beans container:	250 g

The appliance complies with the following EU directives:

- EC Regulation 1275/2008 for standby;
- Low Voltage Directive 2006/95/EC and subsequent amendments;
- EMC Directive 2004/108/EC and subsequent amendments;
- All materials and accessories coming into contact with food conform to EC regulation 1935/2004.

DISPOSAL



In compliance with European directive 2002/96/EC, the appliance must not be disposed of with household waste, but taken to an authorised waste separation and recycling centre.

MESSAGES DISPLAYED

MESSAGE DISPLAYED	POSSIBLE CAUSE	SOLUTION
FILL TANK	Insufficient water in the tank.	Fill the tank with water and/or insert it correctly, pushing it as far as it will go until it clicks into place (fig. 4).
EMPTY GROUNDS CONTAINER	The grounds container (A13) is full.	Empty the grounds container and drip tray, clean and replace (fig. 23). Important: When removing the drip tray, the grounds container must be emptied, even if it contains few grounds. If this is not done, when you make the next coffees, the grounds container may fill up more than expected and clog the machine.
GROUND TOO FINE ADJUST MILL <i>alternating</i> WITH TURN STEAM KNOB	The grinding is too fine and the coffee is delivered too slowly or not at all.	Repeat coffee delivery and turn the grinding dial (fig. 8) one click clockwise towards "7" while the coffee mill is in operation. If after making at least 2 coffees delivery is still too slow, repeat the correction procedure, turning the grinding dial another click until delivery is correct (see the section "Adjusting the grinder" on page 11). If the problem persists, turn the steam knob to the I position and let some water run from the cappuccino maker.
INSERT GROUNDS CONTAINER	After cleaning, the grounds container has not been replaced.	Remove the drip tray and insert the grounds container.
ADD PRE-GROUND COFFEE	The "pre-ground coffee" function has been selected without placing any pre-ground coffee in the funnel.	Place pre-ground coffee in the funnel or deselect the pre-ground function.
DESCALE	The machine must be descaled.	The descaling procedure described in the "Descaling" section (page 14) needs to be performed as soon as possible.
LESS COFFEE	Too much coffee has been used.	Select a milder taste or reduce the quantity of pre-ground coffee.
FILL BEANS CONTAINER	The coffee beans have run out.	Fill the beans container.
	The pre-ground coffee funnel is clogged.	Empty the funnel with the help of a brush, as described in the section "Cleaning the pre-ground coffee funnel".
INSERT INFUSER ASSEMBLY	The infuser has not been properly replaced after cleaning.	Insert the infuser as described in the section "Cleaning the infuser" (page 14).
INSERT TANK	The tank is not correctly in place.	Insert the tank correctly and press as far as it will go.

GENERAL ALARM	The inside of the appliance is very dirty.	Clean the inside of the appliance thoroughly, as described in the section "Cleaning" (page 13). If the message is still displayed after cleaning, contact De'Longhi Customer Services.
REPLACE FILTER	The water softener filter has been used up.	Replace the filter or remove it as described in the section "Water softener filter" (page 15).
EMPTY CIRCUIT FILL CIRCUIT <i>alternating</i> WITH HOT WATER PRESS OK	The water circuit is empty.	Press OK to deliver water from the spout until it flows out normally.

TROUBLESHOOTING

Below is a list of some of the possible malfunctions.

If the problem cannot be resolved as described, contact customer services.

PROBLEM	POSSIBLE CAUSE	SOLUTION
The coffee is not hot.	The cups were not preheated.	Warm the cups by rinsing them with hot water. (N.B. you can use the hot water function).
	The infuser has cooled down because 2/3 minutes have elapsed since the last coffee was made.	Before making coffee, heat up the infuser by pressing the  button.
	A low coffee temperature is set.	Set a high coffee temperature in the menu.
The coffee is weak or not creamy enough.	The coffee is ground too coarsely.	Turn the grinding dial one click anticlockwise towards "1" while the coffee mill is in operation (fig. 8). Continue one click at a time until coffee delivery is satisfactory. The effect is only visible after 2 coffees have been made (see the section "Adjusting the grinder" on page 11).
	The coffee is unsuitable.	Use pre-ground coffee for espresso machines.
The coffee is delivered too slowly or in drops.	The coffee is ground too finely.	Turn the grinding dial one click clockwise to "7" while the coffee mill is in operation (fig. 10). Continue one click at a time until coffee delivery is satisfactory. The effect is only visible after 2 coffees have been made (see the section "Adjusting the grinder" on page 11).
Coffee does not come out of one or both spouts.	The spouts are blocked.	Clean the spouts with a toothpick.
The frothed milk has large bubbles	The milk is not cold enough or is not semi-skimmed.	You should ideally use skimmed or semi-skimmed milk at refrigerator temperature (about 5°C). If the result is not as you wished, try changing brand of milk.

The milk is not frothed	Cappuccino maker is dirty.	Clean as described in the section "Cleaning the cappuccino maker after use" (page 13).
	The ring on the cappuccino maker is NOT in the cappuccino position.	Place the ring in the CAPPUCCINO position.
Steam delivery stops	A safety device stops steam delivery after 3 minutes.	Wait, and then enable the steam function again.
The appliance does not turn on.	It is not plugged into the mains socket.	Plug into the mains socket.
	The main switch (A8) is not turned on.	Push the main switch in the I position (fig. 1).

ELECTRICAL CONNECTION (UK ONLY)

Before using this appliance ensure that the voltage indicated on the product corresponds with the main voltage in your home, if you are in any doubt about your supply contact your local electricity company.

The flexible mains lead is supplied connected to a B.S. 1363 fused plug having a fuse of 13 amp capacity.

Should this plug not fit the socket outlets in your home, it should be cut off and replaced with a suitable plug, following the procedure outlined below.

Note: Such a plug cannot be used for any other appliance and should therefore be properly disposed of and not left where children might find it and plug it into a supply socket - with the obvious consequent danger.

Please note: We recommend the use of good quality plugs and wall sockets that can be switched off when the machine is not in use.

IMPORTANT: The wires in the mains lead fitted to this appliance are coloured in accordance with the following code:

GREEN AND YELLOW
BLUE
BROWN

EARTH
NEUTRAL
LIVE

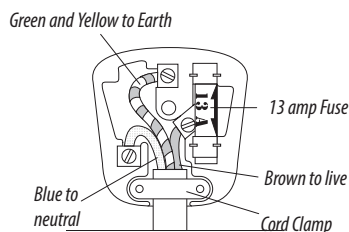

As the colours of the wires in the mains lead of this appliance may not correspond with the coloured markings identifying the terminals in your plug, proceed as follows:

- The wire which is coloured green and yellow must be connected to the terminal in the plug which is marked with the letter E or by the earth symbol  or coloured green or green and yellow.
- The wire which is coloured blue must be connected to the terminal which is marked with the letter N or coloured black.
- The wire which is coloured brown must be connected to the terminal which is marked with the letter L or coloured red.

When wiring the plug, ensure that all strands of wire are securely retained in each terminal. Do not forget to tighten the mains lead clamp on the plug. If your electricity supply point has only two pin socket outlets, or if you are in doubt, consult a qualified electrician.

Should the mains lead ever require replacement, it is essential that this operation be carried out by a qualified electrician and should only be replaced with a flexible cord of the same size.

After replacement of a fuse in the plug, the fuse cover must be refitted. If the fuse cover is lost, the plug must not be used until a replacement cover is obtained. The colour of the correct replacement fuse cover is that of the coloured insert in the base of the fuse recess or elsewhere on the plug. Always state this colour when ordering a replacement fuse cover.