

CONTENTS

1. FUNDAMENTAL SAFETY WARNINGS.....	7
2. SAFETY WARNINGS	8
2.1 Symbols used in these instructions	8
2.2 Designated use.....	8
2.3 Instruction for Use.....	8
3. INTRODUCTION.....	8
3.1 Letters in brackets	8
3.2 Troubleshooting and repairs.....	8
4. DESCRIPTION.....	9
4.1 Description of the appliance.....	9
4.2 Description of the control panel	9
4.3 Description of the accessories	9
4.4 Description of the milk container	9
5. BEFORE USE.....	9
5.1 Checking the appliance	9
5.2 Installing the appliance.....	9
5.3 Connecting the appliance.....	9
5.4 Setting up the appliance	10
6. TURNING THE APPLIANCE ON.....	10
7. TURNING THE APPLIANCE OFF	10
8. MENU SETTINGS	10
8.1 Descale.....	10
8.2 Adjust time	10
8.3 Auto-off	11
8.4 Auto-start	11
8.5 Set temperature.....	11
8.6 Energy saving.....	11
8.7 Set water hardness.....	11
8.8 Set language	11
8.9 Install filter	11
8.10 Remove filter.....	11
8.11 Replace filter	12
8.12 Default values (reset)	12
8.13 Statistics function.....	12
9. RINSING.....	12
10. MAKING COFFEE.....	12
10.1 Selecting the coffee taste	12
10.2 Selecting the quantity of coffee in the cup..	12
10.3 Adjusting the coffee mill	12
10.4 Tips for a hotter coffee.....	13
10.5 Making coffee using coffee beans	13
10.6 Making coffee using pre-ground coffee.....	13
11. MAKING CAPPUCCINOS AND MILK-BASED COFFEES	13
11.1 Filling and attaching the milk container.....	13
11.2 Adjusting the amount of froth	14
11.3 Making cappuccino	14
11.4 Making frothed milk (without coffee)	14
11.5 Making milk without froth (without coffee)	14
12. CLEANING THE MILK CONTAINER AFTER USE ..	14
12.1 Programming the quantity of coffee and milk in the cup for cappuccino or milk	15
13. PREPARING HOT WATER	15
13.1 Changing the quantity of water delivered automatically	15
14. CLEANING.....	15
14.1 Cleaning the machine	15
14.2 Cleaning the machine's internal circuit.....	15
14.3 Cleaning the coffee grounds container	15
14.4 Cleaning the drip tray and condensate tray ..	16
14.5 Cleaning the inside of the coffee machine...	16
14.6 Cleaning the water tank.....	16
14.7 Cleaning the coffee spouts	16
14.8 Cleaning the pre-ground coffee funnel	16
14.9 Cleaning the infuser	16
14.10 Cleaning the milk container	17
14.11 Cleaning the hot water/steam connection nozzle.....	17
15. DESCALING.....	17
16. SETTING WATER HARDNESS	18
16.1 Measuring water hardness	18
16.2 Setting water hardness	18
17. WATER SOFTENER FILTER	18
17.1 Installing the filter	18
17.2 Replacing the filter.....	19
17.3 Removing the filter	19
18. TECHNICAL DATA.....	19
19. DISPOSAL.....	19
20. DISPLAYED MESSAGES.....	20
21. TROUBLESHOOTING	21
22. ELECTRICAL CONNECTION (UK ONLY)	23

1. FUNDAMENTAL SAFETY WARNINGS

- The appliance is not intended for use by persons (including children) with reduced physical, sensory or mental capabilities, or lack of experience and knowledge, unless they have been given supervision or instruction concerning use of the appliance by a person responsible for their safety.
- Children should be supervised to ensure that they do not play with the appliance.
- Cleaning and user maintenance shall not be made by children without supervision.
- Never clean by immersing the appliance in water.
- This is an household appliance only. It is not intended to be used in: staff kitchen areas in shops, offices and other working environments; farm houses; by clients in hotels, motels and other residential type environments; bed and breakfast type environments.
- If the plug or cord is damaged, it must be replaced by Customer Services only to avoid all risk.

FOR EUROPEAN MARKETS ONLY:

- This appliance can be used by children aged from 8 years and above if they have been given supervision or instruction concerning use of the appliance in a safe way and understand the hazards involved. Cleaning and user maintenance shall not be made by children unless they are older than 8 and supervised. Keep the appliance and power cord away from children under 8 years of age.
- Appliances can be used by persons with reduced physical, sensory or mental capabilities or lack of experience and knowledge if they are supervised or have been given instruction concerning use of the appliance in a safe way and if they understand the hazards involved.
- Children shall not play with the appliance.
- Always unplug the appliance when left unattended and before assembly, taking apart or cleaning.



Surfaces marked with this symbol become hot during use (the symbol is present in certain models only).

2. SAFETY WARNINGS

2.1 Symbols used in these instructions

Important warnings are identified by these symbols. It is vital to respect these warnings.



Failure to observe the warning may result in life threatening injury by electric shock.



Failure to observe the warning could result in injury or damage to the appliance.



Failure to observe the warning could result in scalds or burns.



This symbol identifies important advice or information for the user.



This is an electrical appliance and may cause electric shock. You should therefore follow these safety warnings:

- Never touch the appliance with damp hands or feet.
- Never touch the plug with damp hands.
- Make sure the socket used is freely accessible at all times, enabling the appliance to be unplugged when necessary.
- Unplug directly from the plug only. Never pull the cord as you could damage it.
- To disconnect the appliance completely you must unplug it from the mains socket.
- If the appliance is faulty, do not attempt to repair. Turn it off, unplug from the mains socket and contact Customer Services.
- Before cleaning the appliance, turn it off, unplug from the mains socket and allow to cool.



Keep all packaging (plastic bags, polystyrene foam) away from children.



This appliance produces hot water and steam may form while it is in operation.

Avoid contact with splashes of water or hot steam.

When the appliance is in operation, the cup shelf (A3) could become very hot.

2.2 Designated use

This appliance is designed and made to prepare coffee and hot drinks.

Any other use is considered improper and thus dangerous. The manufacturer is not liable for damage deriving from improper use of the appliance.

2.3 Instruction for Use

Read this Instruction for Use carefully before using the appliance. Failure to follow this Instruction for Use may result in injury or damage to the appliance.

The manufacturer is not liable for damage deriving from failure to respect this Instruction for Use.



Keep this Instruction for Use. If the appliance is passed to other persons, they must also be provided with this Instruction for Use.

3. INTRODUCTION

Thank you for choosing this bean to cup espresso and cappuccino machine.

We hope you enjoy using your new appliance.

Take a few minutes to read this Instruction for Use. This will avoid all risks and damage to the appliance.

3.1 Letters in brackets

The letters in brackets refer to the legend in the description of the appliance on pages 2-3.

3.2 Troubleshooting and repairs

In the event of problems, first try and resolve them following the information given in sections "20. Displayed messages" and "21. Troubleshooting".

If this does not resolve the problem or you require further information, you should consult Customer Services by calling the number given on the annexed "Customer Service" sheet.

If your country is not among those listed on the sheet, call the number given in the guarantee. If repairs are required, contact De'Longhi Customer Services only. The addresses are given in the guarantee certificate provided with the machine.

4. DESCRIPTION

4.1 Description of the appliance









(page 3 - A)

- A1. Control panel
- A2. Grinding adjustment dial
- A3. Cup shelf
- A4. Beans container lid
- A5. Pre-ground coffee funnel lid
- A6. Pre-ground coffee funnel
- A7. Beans container
- A8. Main switch
- A9. Power cord connector socket
- A10. Water tank
- A11. Infuser door
- A12. Infuser
- A13. Coffee spouts (adjustable height)
- A14. Coffee grounds container
- A15. Condensate tray
- A16. Cup tray
- A17. Drip tray water level indicator
- A18. Drip tray
- A19. Hot water/steam connection nozzle

4.2 Description of the control panel

(page 2 - B)

A number of buttons on the panel have a double function. This is indicated in brackets in the description.

- B1. Display: guides the user in using the appliance
- B2.  button: turns the appliance on and off
- B3. **MENU** button to access the menu (*when in the settings MENU: "ESC" button to exit from the selected function and go back to the main menu*)
- B4.  button: to deliver steam to make cappuccino and milk-based coffees (*when in the settings MENU: < button to scroll backwards*)
- B5.  button: to rinse the appliance (*when in the settings MENU: > button to scroll forwards*)
- B6.  button: to make coffee using pre-ground coffee (*when in the settings MENU: "OK" button to confirm the current selection*)
- B7.  aroma selection button: to select the coffee taste
- B8.  button: to make 1 cup of short espresso coffee
- B9.  button: to make 2 cups of short espresso coffee
- B10. **CAPPUCCINO** button: to make 1 cup of cappuccino or frothed milk
- B11.  button: to make 1 cup of long espresso coffee
- B12.  button: to make 2 cups of long espresso coffee

4.3 Description of the accessories

(page 2 - C)

- C1. Indicator paper
- C2. Measure
- C3. Descaler
- C4. Water softener filter
- C5. Brush
- C6. Hot water spout
- C7. Power cord

4.4 Description of the milk container

(page 3 - D)

- D1. Froth adjustment dial
- D2. Milk container lid
- D3. Milk container
- D4. Milk intake tube
- D5. Frothed milk spout (adjustable)

5. BEFORE USE

5.1 Checking the appliance

After removing the packaging, make sure the product is complete and undamaged and that all accessories are present. Do not use the appliance if it is visibly damaged. Contact De'Longhi Customer Services.

5.2 Installing the appliance



Important!

When you install the appliance, you should respect the following safety warnings:

- The appliance gives off heat. After positioning the appliance on the worktop, leave a space of at least 3 cm between the surfaces of the appliance and the side and rear walls and at least 15 cm above the machine.
- Water penetrating the coffee maker could cause damage. Do not place the appliance near taps or sinks.
- The appliance could be damaged if the water it contains freezes.
Do not install the appliance in a room where the temperature could drop below freezing point.
- Arrange the power cord (C7) in such a way that it cannot be damaged by sharp edges or contact with hot surfaces (e.g. electric hot plates).

5.3 Connecting the appliance



Important!

Check that the mains power supply voltage corresponds to that indicated on the rating plate on the bottom of the appliance. Connect the appliance to an efficiently earthed and correctly installed socket with a minimum current rating of 10A only.

If the power socket does not match the plug on the appliance, have the socket replaced with a suitable type by a qualified electrician.

5.4 Setting up the appliance

Please note:

- Coffee has been used to factory test the appliance and it is therefore completely normal for there to be traces of coffee in the mill. The machine is, however, guaranteed to be new.
- You should customise water hardness as soon as possible following the instructions in section “16. Setting water hardness”.

1. Insert the power cord connector (C7) into the socket at the back of the appliance (A9) and connect the appliance to the mains electricity supply (fig. 1). Make sure the main switch (A8) at the back of the appliance is pressed (fig. 2).

You must first choose the language (the languages scroll through at intervals of about 3 seconds):

2. When “English” appears, press the  button (B6) (fig. 3) for a few seconds until “ENGLISH set” appears on the display (B1).

Follow the instructions indicated on the appliance display:

3. “FILL TANK”: remove the water tank (A10), fill to the MAX line with fresh water (fig. 4A), then replace in the appliance (fig. 4B).
4. “INSERT WATER SPOUT”: Check that the hot water spout (C6) is inserted on the connection nozzle and place a container holding a minimum of 100ml underneath (fig. 5);
5. “Hot water Confirm?” appears on the display;
6. Press the  button to confirm. The appliance delivers water from the spout then goes off automatically.

The coffee machine is now ready for normal use.

Please note:

- When setting up the appliance, you need to make 4-5 cups of coffee or 4-5 cappuccinos before the appliance starts to give satisfactory results.

6. TURNING THE APPLIANCE ON

Please note:

Before turning the appliance on, make sure the main switch (A8) on the back of the appliance is pressed (fig. 2).

Each time the appliance is turned on, it performs an automatic preheat and rinse cycle which cannot be interrupted. The appliance is ready for use only after completion of this cycle.

Danger of burns!

During rinsing, a little hot water comes out of the coffee spouts (A13) and is collected in the drip tray (A18) underneath. Avoid contact with splashes of water.

- To turn the appliance on, press the  button (B2) (fig. 6). The message “Heating up Please wait” appears on the display (B1).

When heating is complete, the message changes to “Rinsing”. As well as heating the boiler, this also heats the internal circuits by circulating hot water.

The appliance is at temperature when the message “Ready” appears on the display and the taste has been selected.

7. TURNING THE APPLIANCE OFF

Each time the appliance is turned off, it performs an automatic rinse cycle which cannot be interrupted.

Danger of burns!

During rinsing, a little hot water flows from the coffee spouts (A13).

Avoid contact with splashes of water.

To turn the appliance off, press the  button (B2) (fig. 6). The appliance performs a rinse cycle then goes off (stand-by).

Please note:

If you will not be using the appliance for some time, unplug from the mains socket:

- first turn the appliance off by pressing the  button (fig. 6);
- press the main switch (A8) (fig. 2).

Important!

Never press the main switch while the appliance is on.









8. MENU SETTINGS

8.1 Descale

For instructions on descaling, see section “15. Descaling”.

8.2 Adjust time







To adjust the time on the display (B1), proceed as follows:

1. Press the **MENU** button (B3) to enter the menu;
2. Press the  (B4) or  (B5) button until “Adjust time” appears on the display (B1);
3. Press the  button (B6);
4. Press the  or  button to change the hour;
5. Press the  button to confirm;
6. Press the  or  button to change the minutes;
7. Press the  button to confirm.

The time is set: press the MENU button to exit the menu.

8.3 Auto-off

Auto-off can be set so that the appliance goes off after 15 or 30 minutes, or after 1, 2 or 3 hours.

1. Press the **MENU** button (B3) to enter the menu;
2. Press the  (B4) or  (B5) finchè appare sul display (B1) la scritta "Autospegnimento";
3. Press the  button (B6);
4. Press the  or  until the number of minutes/hours of operation appears on the display (15 or 30 minutes, or 1, 2 or 3 hours);
5. Press the  button to confirm.











Auto-off is set. Press the **MENU** button to exit the menu.

8.4 Auto-start

You can set the auto-start time in order to have the appliance ready at a certain time (for example in the morning) so you can make coffee immediately.



Please note :

To enable this function, the time must already be set correctly.

1. Press the **MENU** (B3) button to enter the menu;
2. Press the  (B4) or  (B5) button until "Auto-start" appears on the display (B1);
3. Press the  (B6) button (B6). "Enable?" appears on the display;
4. Press the  button to confirm;
5. Press the  or  button to choose the hour;
6. Press the  button to confirm;
7. Press the  or  button to change the minutes;
8. Press the  button to confirm;
9. Then press the **MENU** button to exit the menu.

Once the time has been confirmed, activation of auto-start is indicated by the  symbol displayed alongside the time and under "Auto-start" in the menu.



To disable the function:

1. Select auto-start from the menu;
2. Press the  button. "Disable?" appears on the display;
3. Press the  button to confirm.

The  symbol is no longer displayed.

8.5 Set temperature

If you want to modify the temperature of the water used to make the coffee (low, medium, high, maximum), proceed as follows:

1. Press the **MENU** button (B3) to enter the menu;
2. Press the  (B4) or  (B5) button until "Set temperature" appears on the display (B1);
3. Press the  button (B6);

4. Press the  or  button until the required temperature (low, medium, high, maximum) appears on the display;





5. Press the  button to confirm.

The temperature is set. Press the **MENU** button to exit the menu.

8.6 Energy saving

Use this function to enable or disable energy saving. When enabled, the function reduces energy consumption in compliance with European regulations.

When energy saving mode is active, an asterisk appears below "Energy saving" in the menu.

1. Press the **MENU** button (B3) to enter the menu;
2. Press the  (B4) or  (B5) button until "Energy saving" appears on the display;
3. Press the  button (B6). "Enable?" or "Disable?" appears on the display;
4. Press the  button to enable or disable energy saving mode.

Then press the **MENU** button to exit the menu.

When the function is active, if the machine is not used for some time, "Energy Saving" appears on the display.

Please note:







When in energy saving mode, a few seconds may elapse before the first coffee is delivered as the appliance must heat up again.

8.7 Set water hardness

For instructions on setting water hardness, see section "16. Setting water hardness".

8.8 Set language

To modify the language on the display, proceed as follows:

1. Press the **MENU** button (B3) to enter the menu;
2. Press the  (B4) or  (B5) button until "Set language" appears on the display (B1);
3. Press the  button (B6);
4. Press the  or  button until the required language appears on the display;
5. Press the  button to confirm;

The language is set. Press the **MENU** button to exit the menu.

8.9 Install filter

For instructions on how to install the filter (C4), see section "17.1 Installing the filter".

8.10 Remove filter





For instructions on how to remove the filter (C4), see section "17.3 Removing the filter".

8.11 Replace filter

For instructions on how to replace the filter (C4), see section "17.2 Replacing the filter".

8.12 Default values (reset)







This resets all menu settings and programmed quantities back to the default values (with the exception of the language which remains as set).

1. Press the **MENU** button (B3) to enter the menu;
2. Press the  (B4) or  (B5) button until "Default values" appears on the display (B1);
3. Press the -button (B6);
4. The message "Confirm?" appears on the display;
5. Press the  button to confirm and exit.

8.13 Statistics function

This displays statistics relating to the machine.

To display, proceed as follows:

1. Press the **MENU** button (B3) to enter the menu;
2. Press the  (B4) or  (B5) button until "Statistics" appears on the display (B1);
3. Press the -button (B6);
4. By pressing the  or  button you can check:
 - how many coffees have been made;
 - how many times the machine has been descaled;
 - the total number of litres of water delivered;
 - how many times the water filter has been replaced;
 - how many cappuccinos and milk-based coffees have been made (CAPPUCCINO).
5. Press the  button twice to exit the menu.

9. RINSING

Use this function to deliver hot water from the coffee spouts (A13) and hot water spout (C6, if inserted), to clean and heat the appliance's internal circuit.

Place a container with a minimum capacity of 100ml under the hot water spout (fig. 5).



Danger of burns!

Do not leave the appliance unattended while hot water is being delivered.

To enable the function, proceed as follows:

1. Press the  button (B5);
2. After a few seconds, hot water is delivered first from the coffee spouts, then from the hot water spout (if inserted) to clean and heat the appliance's internal circuit. "RINSING" appears on the display, together with a progress bar which fills gradually as preparation proceeds;
3. To stop the process press any button or wait for delivery of water to stop automatically.



Please note:

- If the appliance is not used for more than 3-4 days, when switched on again, we strongly recommend performing 2/3 rinses before use;
- After cleaning, it is normal for the coffee grounds container (A14) to contain water.

10. MAKING COFFEE

10.1 Selecting the coffee taste

The appliance is set by default to make coffee with a standard taste.

You can also choose one of these tastes:

Extra-mild taste

Mild taste

Standard taste





Strong taste

Extra-strong taste

To change the taste, press the  button (B7) (fig. 7) repeatedly until the required taste appears on the display (B1).

10.2 Selecting the quantity of coffee in the cup

The appliance is set by default to automatically make the following quantities of coffee:

- short espresso coffee (≈40ml) when the  (B8) button (B8) is pressed;
- long espresso coffee (≈120ml) when the  (B11) button (B11) is pressed;
- two short espresso coffees when the  button (B9) is pressed;
- two long espresso coffees when the  button (B12) is pressed.

To change the quantity of coffee the appliance delivers automatically into the cup, proceed as described below:

- press and hold the button corresponding to the quantity to be modified until "PROGRAM QUANTITY" appears on the display (B1), then release the button;
- when the coffee in the cup reaches the desired level, press the same button again to memorise the new amount.

The machine is now reprogrammed with the new quantities.

10.3 Adjusting the coffee mill

The coffee mill is set by default to prepare coffee correctly and should not require regulating initially.

However, if after making the first few coffees you find that the coffee is either too weak and not creamy enough or delivery is too slow (a drop at a time), this can be corrected by adjusting the grinding adjustment dial (A2) (fig. 8).

i Please note :

The grinding adjustment dial must only be turned when the coffee mill is in operation.

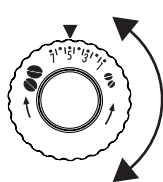

If the coffee is delivered too slowly or not at all, turn one click clockwise. For fuller bodied creamier coffee, turn one click anticlockwise (do not turn more than one click at a time otherwise the coffee could be delivered a drop at a time).

These adjustments will only be evident after at least 2 cups of coffee have been delivered. If this adjustment does not obtain the desired result, turn the dial another click.

10.4 Tips for a hotter coffee

For hotter coffee, you should:

- before delivering the coffee, perform a rinse cycle by pressing the  button (B5). Hot water is delivered from the coffee spouts (A13) then the hot water spout (C6, if present), heating and cleaning the internal circuit of the appliance and thus raising the coffee temperature;
- set a hotter coffee temperature in the settings menu (see section “8.5 Setting the temperature”).

10.5 Making coffee using coffee beans

! Important!

Do not use caramelised or candied coffee beans as they could stick to the coffee mill and damage it.

1. Fill the container (A7) (fig. 9) with coffee beans.
2. Place under the coffee spouts (A13):
 - 1 cup, if you want to make 1 coffee (fig. 10);
 - 2 cups, if you want 2 coffees (fig. 11);
3. Lower the spouts as near as possible to the cup. This makes a creamier coffee (fig. 12);
4. Press the button corresponding to the required coffee:



5. Preparation begins and information on the coffee selected appears on the display (B1).

Once the coffee has been made, the appliance is ready to make the next drink.

i Please note :

- While the machine is making coffee, delivery can be interrupted at any moment by pressing one of the coffee buttons.

- At the end of delivery, to increase the quantity of coffee in the cup, just press one of the coffee buttons (within 3 seconds).
- For hotter coffee, see section “10.4 Tips for a hotter coffee”.

! Important!

- If the coffee is delivered a drop at a time, too weak and not creamy enough or too cold, read the tips in section “21. Troubleshooting”.
- Various alarm messages could be displayed while the machine is in use. Their meaning is explained in section “20. Displayed messages”.

10.6 Making coffee using pre-ground coffee



! Important!

- Never place coffee beans in the pre-ground coffee funnel (A6) as this could damage the appliance.
- Never add pre-ground coffee when the machine is off or it could spread through the inside of the machine and dirty it. This could damage the appliance.
- Never use more than 1 level measure (C2) or it could dirty the inside of the coffee machine or block the funnel.



i Please note :

When you use pre-ground coffee, you can only make one cup of coffee at a time.

1. Make sure the appliance is on;
2. Press the  button (B6);
3. Make sure the funnel is not blocked, then add one level measure of pre-ground coffee (fig. 13);
4. Place a cup under the coffee spouts (A13);
5. Press the corresponding one cup coffee button (B8 -  or B11 - );
6. Preparation begins.

11. MAKING CAPPUCCINOS AND MILK-BASED COFFEES

i Please note!

- To avoid producing milk with poor froth or large bubbles, always clean the milk container lid (D2) and hot water connection nozzle (A19) as described in sections “12. Cleaning the milk container after every use”, “14.10 Cleaning the milk container” and “14.11 Cleaning the hot water/steam connection nozzle”.

11.1 Filling and attaching the milk container

1. Remove the lid (D2) (fig. 14);

- Fill the milk container (D4) with a sufficient quantity of milk, not exceeding the MAX level marked on the container (fig. 15). Each mark on the side of the container corresponds to 100ml of milk.

i Please note!

- For a denser more even froth, you must use skimmed or partially skimmed milk at refrigerator temperature (about 5°C).
 - If “energy saving” mode is enabled, you may have to wait a few seconds before the drink is delivered.
- Make sure the milk intake tube (D5) is correctly inserted in the bottom of the milk container lid (fig. 16);
 - Place the lid back on the milk container;
 - Remove the hot water spout (C6) from the connection nozzle;
 - Attach the container to the connection nozzle, pushing as far as it will go (fig. 17);
 - Place a sufficiently large cup under the coffee spouts and frothed milk spout (D3). Adjust the length of the milk spout. To move it nearer the cup, simply pull it downwards (fig. 18);
 - Follow the instructions below for each function.

11.2 Adjusting the amount of froth

Turn the froth adjustment dial (D1) on the milk container lid (D2) to adjust the amount of froth on the milk delivered while making cappuccino and milk-based coffee.

Dial position	Description	Recommended for...
	No froth	caffelatte/hot milk (without froth)
	Min. froth	macchiato
	Max. froth	CAPPUCCINO/ FROTHED MILK

11.3 Making cappuccino

- Fill the milk container (D) and attach it as described above;
- Turn the froth adjustment dial (D1) on the milk container lid (D2) to the position corresponding to the required froth;
- Press the CAPPUCCINO button (B10). “CAPPUCCINO” appears on the display (B1), together with a progress bar which fills gradually as preparation proceeds;
- After a few seconds, milk is delivered from the milk spout (D3) into the cup below. For drinks with coffee, the ma-

chine automatically makes the coffee after delivering the milk.

i Please note!

- If during delivery you want to stop making milk or coffee, press the CAPPUCCINO button twice.
- At the end of delivery, to increase the quantity of milk or coffee in the cup, within 3 seconds, press and hold the CAPPUCCINO button.
- Do not leave the milk container out of the refrigerator for long periods. The warmer the milk (5°C is ideal), the poorer the quality of froth produced.

11.4 Making frothed milk (without coffee)

Proceed as described in the previous section (“11.3 Making cappuccino”), pressing the CAPPUCCINO button (B10) twice instead of once.

i Please note!

If during delivery you want to stop preparation, press the CAPPUCCINO button once.

11.5 Making milk without froth (without coffee)

Proceed as described in the previous section, turning the froth adjustment dial (D1) to the  position.

12. CLEANING THE MILK CONTAINER AFTER USE

⚠ Important! Danger of burns

When cleaning the internal tubes of the milk container (D), a little hot water and steam leak out of the frothed milk spout (D3). Avoid contact with splashes of water.

After preparing a cappuccino or milk-based coffee, the machine must be cleaned to remove the milk residues.

Proceed as follows:

- Leave the milk container in the machine (you do not need to empty it);
- Place a cup or other recipient under the frothed milk spout;
- Turn the froth adjustment dial (D1) to CLEAN (fig. 19): the operation appears on the display (B1) and stops automatically;
- Turn the dial back to one of the froth selections;
- Remove the milk container and always clean the steam connection nozzle (A19) with a sponge (fig. 20);

i Please note!

- To prepare a number of cappuccinos or milk-based coffees, clean the milk container after you have prepared the last drink only.
- The milk container can be kept in the refrigerator.

- In some cases, to clean you must wait for the appliance to heat up.

12.1 Programming the quantity of coffee and milk in the cup for cappuccino or milk

The appliance is set by default to automatically deliver standard quantities. To change these quantities, proceed as follows:

1. Place a cup under the coffee spouts (A13) and milk spout (D3);
2. Press and hold the CAPPUCCINO button (B10) until the message “PROGRAM MILK Program Quantity” appears on the display (B1);
3. Release the button. The appliance starts delivering milk;
4. Once the required quantity of milk has been delivered into the cup, press the CAPPUCCINO button again;
5. The appliance stops delivering milk and after a few seconds the coffee is delivered into the cup. “PROGRAM COFFEE Program Quantity” appears on the display;
6. Once the required quantity of coffee has been delivered into the cup, press the CAPPUCCINO button. Coffee delivery stops.

The machine is now reprogrammed with the new milk and coffee quantities.

13. PREPARING HOT WATER



Important! Danger of burns

Never leave the machine unattended while delivering hot water. The hot water spout (C6) becomes hot during delivery. Hold by the handle only.

1. Make sure the hot water spout is attached correctly;
2. Place a container under the hot water spout (as close as possible to avoid splashes);
3. Press the ☉ button (B4) (fig. 21). “HOT WATER” appears on the display (B1), together with a progress bar which fills gradually as preparation proceeds;
4. The machine delivers 250ml of hot water, then delivery stops automatically. To interrupt delivery of hot water manually, press the ☉ button again.



Please note!

If “Energy Saving” mode is active, you may have to wait a few seconds before the hot water is delivered.

13.1 Changing the quantity of water delivered automatically

The machine is set by default to automatically deliver 250ml of hot water. To modify these quantities, proceed as follows:

1. Position a container under the hot water spout (C6);

2. Press and hold the ☉ button (B4) until “Hot Water Program Quantity” appears on the display (B1), then release the ☉ button;
3. When the hot water in the cup reaches the required level, press the ☉ button again.

The machine is now reprogrammed with the new quantity.

14. CLEANING

14.1 Cleaning the machine

The following parts of the machine must be cleaned regularly:

- the appliance's internal circuit;
- coffee grounds container (A14);
- drip tray (A18);
- water tank (A10);
- coffee spouts (A13);
- hot water/steam connection nozzle (A19);
- pre-ground coffee funnel (A6);
- infuser (A12), accessible after opening the infuser door (A11).



Important!

- Do not use solvents, abrasive detergents or alcohol to clean the coffee machine. With De'Longhi superautomatic coffee machines, you need not use chemical products to clean the machine.
- None of the components of the appliance can be washed in a dishwasher with the exception of the milk container.
- Do not use metal objects to remove encrustations or coffee deposits as they could scratch metal or plastic surfaces.

14.2 Cleaning the machine's internal circuit

If the appliance is not used for more than 3/4 days, before using it again, we strongly recommend switching it on and:

- performing 2/3 rinse cycles by pressing the ☉ button (B5);
- delivering hot water for a few seconds by pressing the ☉ button (B4) with the hot water spout (C6) inserted on the appliance.



Please note :

After cleaning, it is normal for the grounds container (A14) to contain water.

14.3 Cleaning the coffee grounds container

When “EMPTY GROUNDS CONTAINER” appears on the display (B1), the grounds container must be emptied and cleaned. Until the grounds container (A14) has been cleaned, the appliance continues to display the message and coffee cannot be made.

To clean (with the machine on):

- remove the drip tray (A18) (fig. 22), empty and clean;

- Empty the grounds container and clean thoroughly to remove all residues left on the bottom;
- Check the condensate tray (A15) (red) and empty if necessary.

 **Important!**

When removing the drip tray, the grounds container **must** be emptied, even if it contains few grounds.

If this is not done, when you make the next coffees, the grounds container may fill up more than expected and clog the machine.

14.4 Cleaning the drip tray and condensate tray

 **Important!**

If the drip tray (A18) is not emptied regularly, the water could overflow from the edge and seep inside or around the machine. This could damage the machine, the surface it rests on or the surrounding area.

The drip tray is fitted with a level indicator (A17) (red) showing the level of water it contains (fig. 23). Before the indicator protrudes from the cup tray (A16), the drip tray must be emptied and cleaned.

To remove the drip tray:

1. Remove the drip tray and the grounds container (A14) (fig. 22);
2. Empty the drip tray and grounds container and wash them;
3. Check the condensate tray (A15) (red) and empty if necessary;
4. Replace the drip tray and grounds container.

14.5 Cleaning the inside of the coffee machine

 **Danger!**

Before cleaning internal parts, the machine must be turned off (see section “7. Turning the appliance off”) and unplugged from the mains power supply. Never immerse the coffee machine in water.

1. Check regularly (about once a month) that the inside of the appliance (accessible after removing the drip tray - A18) is not dirty. If necessary, remove coffee deposits with the brush (C5) or a sponge;
2. Remove all the residues with a vacuum cleaner (fig. 24).

14.6 Cleaning the water tank

1. Clean the water tank (A10) regularly (about once a month) and whenever you replace the water softener filter (C4, if provided) with a damp cloth and a little mild washing up liquid;
2. Remove the filter (if present) and rinse with running water;

3. Replace the filter (if provided), fill the tank with fresh water and replace the tank;
4. (Models with water softener filter only) Deliver about 100ml of hot water to reactivate the filter.

14.7 Cleaning the coffee spouts

1. Clean the coffee spouts (A13) with a sponge or cloth (fig. 25A);
2. Check that the holes in the coffee spouts are not blocked. If necessary, remove coffee deposits with a toothpick (fig. 25B).

14.8 Cleaning the pre-ground coffee funnel

Check regularly (about once a month) that the pre-ground coffee funnel (A6) is not blocked.

If necessary, remove coffee deposits with the brush (C5).

14.9 Cleaning the infuser

The infuser (A12) must be cleaned at least once a month.

 **Important!**

The infuser may not be extracted when the machine is on.

1. Make sure the machine is correctly turned off (see section “7. Turning the appliance off”);
2. Remove the water tank (A10);
3. Open the infuser door (A11) (fig. 26) on the right side of the appliance;
4. Press the two coloured release buttons inwards and at the same time pull the infuser outwards (fig. 27);

 **Important!**

RINSE WITH WATER ONLY NO WASHING UP LIQUID – NO DISH WASHER

Clean the infuser without using washing up liquid as it could be damaged.

5. Soak the infuser in water for about 5 minutes, then rinse under the tap;
6. Use the brush (C5) to remove any coffee residues left in the infuser housing, visible through the infuser door;
7. After cleaning, replace the infuser by sliding it onto the internal support (fig. 28), then push the PUSH symbol fully in until it clicks into place;

 **Please note :**

If the infuser is difficult to insert, before insertion, adapt it to the right size by pressing the two levers shown in fig. 29.

8. Once inserted, make sure the two coloured buttons have snapped out (fig. 30);
9. Close the infuser door;
10. Put the water tank back.

14.10 Cleaning the milk container

Clean the milk container (D) each time you prepare milk as described below:

1. Remove the lid (D2);
2. Remove the milk spout (D3) and intake tube (D5) (fig. 31);
3. Turn the froth adjustment dial (D1) clockwise to the "INSERT" position (fig. 31) and pull it off upwards;
4. Wash all the components thoroughly with hot water and mild washing-up liquid. All components are dishwasher safe, placing them in the top basket of the dishwasher. Make sure there are no milk residues on the hollow and groove under the dial (fig. 32). If necessary, scrape the groove with a toothpick;

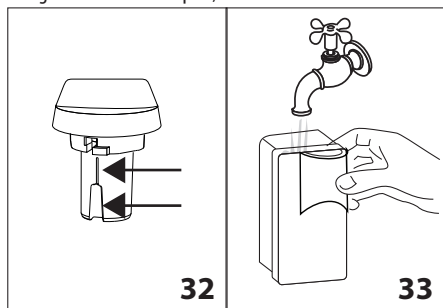

5. Rinse inside the froth adjustment dial seat with running water (fig. 33);
6. Check that the intake tube and spout are not clogged with milk residues;
7. Replace the dial (lining up the arrow with the word "INSERT"), the spout and the milk intake tube;
8. Place the lid back on the milk container.

14.11 Cleaning the hot water/steam connection nozzle

Each time you prepare milk, clean the connection nozzle (A19) with a sponge to remove milk residues from the gaskets (fig. 20).





15. DESCALING

Important!

- Before use, read the instructions and the labelling on the descaler pack (C3).
- You should use De'Longhi descaler only. Using unsuitable descaler and/or performing descaling incorrectly may result in faults not covered by the manufacturer's guarantee.

Descal the machine when the message "DESCALE" flashes on the display (B1).

1. Turn the coffee machine on;

2. Press the **MENU** button (B3) to access the menu;
3. Press the  (B4) or  (B5) button until "Descal" appears on the display;
4. Select by pressing the button  (B6). The message "Descaling Confirm?" appears on the display (B1);
5. Press again  to enable the function. "Add descaler Confirm?" appears on the display, alternating with "EMPTY DRIP TRAY";
6. Extract and empty the drip tray (A18) and grounds container (A14) and put both back in the machine;
7. Empty the water tank (A10) completely and remove the water softener filter (C4 - if present);

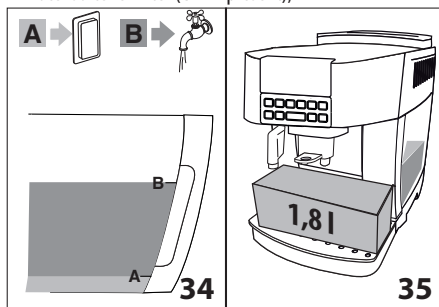

8. Pour the descaler (C3) into the tank up to level **A** (corresponding to a 100ml pack) marked on the inner surface of the tank, then add a litre of water up to level **B** (fig. 34) and put the water tank back in the appliance;
9. Place a container with a minimum capacity of 1.8 litres under the water spout (C6) and coffee spouts (A13) (fig. 35).



Danger of burns!

Hot water containing acid flows out of the water spout and coffee spouts. Take care to avoid contact with splashes of this solution.

10. Press the button  to confirm that the solution has been introduced. "Descal underway" appears on the display. The descale programme starts and the descaler liquid comes out of the water spout and coffee spouts. A series of rinses and pauses is performed automatically to remove all the scale residues inside the coffee machine;

After about 25 minutes, descaling stops and the message "Rinsing FILL TANK" appears on the display. The appliance is now ready for rinsing through with clean water;

11. Empty the container used to collect the descaler solution;
12. Remove the water tank, empty, rinse under running water, fill with fresh water up to the MAX level and put back in the appliance: the message "Rinsing Confirm?" appears on the display;

- Place the container used to collect the descaler solution empty under the spouts and press the  button to confirm. Hot water is delivered first from the water spout to continue and end with the coffee spouts. The message "Rinsing" appears on the display;
- When the water tank is empty, the message "Rinsing FILL TANK" appears on the display;
- Empty the container used to collect the rinsing water;
- Remove the water tank, replace the water softener filter (if previously removed), fill the tank up to the MAX level with cold water and insert in the appliance. "Rinsing... Confirm?" appears on the display;
- Place the container used to collect the rinsing water empty under the water spout (fig. 35) and press the  button to confirm. Hot water is delivered from the water spout;
- When the process is complete, "Descalc complete Confirm?" appears on the display;
- Press the  button to confirm. The message "FILL TANK" appears on the display;
- Top up the water tank with fresh water to the MAX level and put back in the machine.

Descaling is complete.

Please note!

- If the descaling cycle is not completed correctly (e.g. no electricity) we recommend repeating the cycle;
- After descaling, it is normal for the grounds container to contain water.

16. SETTING WATER HARDNESS

The DESCAL message appears on the display after a period of time established according to water hardness.

The machine is set by default for a hardness value of 4.





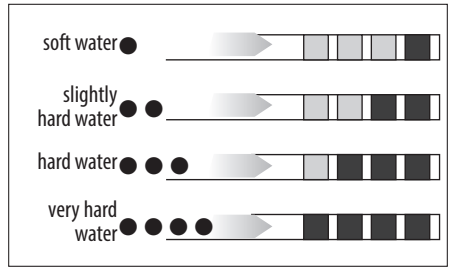

The machine can also be programmed according to the hardness of the mains water in the various regions so that the machine needs to be descaled less often.

16.1 Measuring water hardness

- Remove the "TOTAL HARDNESS TEST" indicator paper (C1) from its pack (attached to the English instructions);
- Immerse the paper completely in a glass of water for about one second;
- Remove the paper from the water and shake lightly. After about a minute, 1, 2, 3, or 4 red squares form, depending on the hardness of the water. Each square corresponds to one level.



16.2 Setting water hardness

- Press the **MENU** button (B3) to enter the menu;
- Press the  (B4) or  (B5) button until "Water hardness" appears on the display (B1);
- Confirm the selection by pressing the  button (B6);
- Press the  or  button repeatedly to set the level as measured by the indicator paper (see previous section);
- Press the  button to confirm the setting.

The machine is now reprogrammed with the new water hardness setting. Press the **MENU** button to exit the menu.

17. WATER SOFTENER FILTER

Certain models are fitted with a water softener filter (C4). If this is not the case with your model, you are recommended to purchase one from De'Longhi Customer Services. To use the filter correctly, follow the instructions below.

17.1 Installing the filter

- Remove the filter (C4) from the packaging;
- Turn the date indicator disk (see fig. 36) until the next two months of use are displayed;

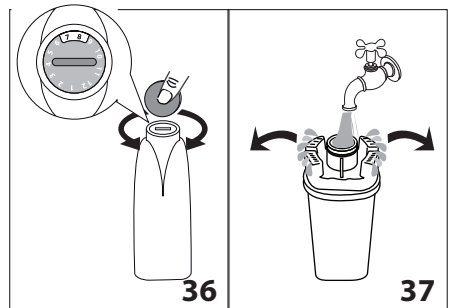

Please note :

The filter lasts about two months if the appliance is used normally. If the coffee machine is left unused with the filter installed, it will last a maximum of three weeks.

- To activate the filter, run tap water through the hole in the filter as shown in the figure until water comes out of the openings at the side for more than a minute (fig. 37);
- Extract the tank (A10) from the appliance and fill with water;
- Insert the filter in the water tank and immerse it completely for about ten seconds, sloping it to enable the air bubbles to escape (fig. 38);

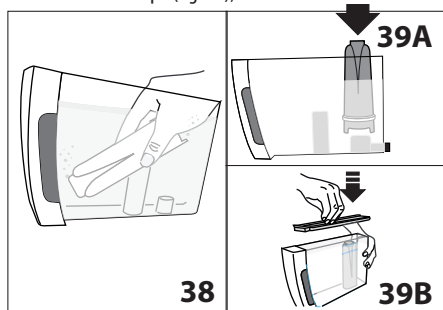

- Insert the filter in its housing (fig. 39A) and push down as far as it will go; soft water slightly hard water hard water very hard water
- Close the tank with the lid (fig. 39B), then replace the tank in the appliance;

When you install the filter, you must notify the appliance of its presence.

- Press the **MENU** button (B3) to enter the menu;
- Press the (B4) or (B5) button repeatedly until "Install filter" appears on the display (B1);
- Press the button (B6);
- "Enable?" appears on the display;
- Press the button to confirm the selection. "HOT WATER Confirm?" appears on the display;
- Position a container under the hot water spout (C6) (min. capacity: 500ml);
- Press the button to confirm the selection. The appliance begins hot water delivery and the message "Please wait..." appears on the display;
- After the flow of hot water stops, the appliance automatically resets to "Ready for coffee" status.

The new filter is active and indicated by an asterisk displayed under "Install filter" in the menu. You can now use the appliance.

17.2 Replacing the filter

When "REPLACE FILTER" appears on the display (B1), after two months (see date indicator) or when the appliance has not been used for 3 weeks, you should replace the filter (C4):

- Extract the tank (A10) and exhausted filter;
- Take the new filter out of its packet and proceed as illustrated in points 3, 4, 5 and 6 in the previous section;

- Position a container under the hot water spout (C6) (min. capacity: 500ml);
- Press the **MENU** button (B3) to enter the menu;
- Press the (B4) or (B5) button repeatedly until "Replace filter" appears on the display (B1);
- Press the button (B6);
- The message "Confirm?" appears on the display;
- Press the button to confirm the selection;
- "HOT WATER Confirm?" appears on the display;
- Press the button to confirm the selection. The appliance begins hot water delivery and the message "Please wait..." appears on the display;
- After the flow of hot water stops, the appliance automatically resets to "Ready for coffee" status.

The new filter is now active and you can use the coffee machine.

17.3 Removing the filter

If you want to use the appliance without the filter (C4), you must remove it and notify the appliance of its removal. Proceed as follows:

- Extract the tank (A10) and exhausted filter;
- Press the **MENU** button (B3) to enter the menu;
- Press the (B4) or (B5) button repeatedly until "Remove filter*" appears on the display (B1);
- Press the button (B6);
- The message "Confirm?" appears on the display;
- Press the button to confirm and the MENU button to exit the menu.

18. TECHNICAL DATA

Voltage:	220-240 V~ 50/60 Hz max. 10A
Absorbed power:	1450W
Pressure:	1,5 MPa (15 bar)
Max. water tank capacity:	1,8 l
Dimensioni LxDxH :	240x430x350 mm
Cord length:	1750 mm
Weight:	9,6 Kg
Max. beans container capacity:	250 g

Max. beans container capacity:

- European Standby Regulation 1275/2008
- Materials and accessories coming into contact with food conform to EEC regulation 1935/2004.

19. DISPOSAL



The appliance must not be disposed of with household waste, but taken to an authorised waste separation and recycling centre.

20. DISPLAYED MESSAGES

DISPLAYED MESSAGE	POSSIBLE CAUSE	SOLUTION
FILL TANK	Insufficient water in the tank (B10).	Fill the tank with water and/or insert it correctly, pushing it as far as it will go until it clicks into place (fig. 4).
EMPTY GROUNDS CONTAINER	The grounds container (A14) is full.	Empty the grounds container and drip tray (A18), clean and replace (fig. 23). Important: when removing the drip tray, the grounds container (A14) must be emptied, even if it contains few grounds. If this is not done, when you make the next coffees, the grounds container may fill up more than expected and clog the machine.
GROUND TOO FINE ADJUST MILL	The grinding is too fine and the coffee is delivered too slowly or not at all.	Repeat coffee delivery and turn the grinding adjustment dial (A2) (fig. 8) one click clockwise towards "7" while the coffee mill is in operation. If after making at least 2 coffees delivery is still too slow, repeat the correction procedure, turning the grinding adjustment dial another click until delivery is correct (see section: "10.3 Adjusting the coffee mill"). If the problem persists, turn the steam dial to the I position and deliver a little water from the hot water spout (C6).
	If the water softener filter (C4) is present, an air bubble may have been released inside the circuit, obstructing delivery.	Insert the hot water spout (C6) in the appliance and deliver a little water until the flow becomes regular.
INSERT GROUNDS CONTAINER	After cleaning, the grounds container (A14) has not been replaced.	Remove the drip tray (A18) and insert the grounds container.
ADD PRE-GROUND COFFEE	The "pre-ground coffee" function has been selected without placing any pre-ground coffee in the funnel (A6).	Place pre-ground coffee in the funnel or deselect the "pre-ground" function.
DESCALE	The machine must be descaled.	The descaling procedure described in section "15. Descaling" needs to be performed as soon as possible.
REDUCE COFFEE AMOUNT	Too much coffee has been used.	Select a milder taste or reduce the quantity of pre-ground coffee.
FILL BEANS CONTAINER	The coffee beans have run out.	Fill the beans container (A7).
	The pre-ground coffee funnel (A6) is clogged.	Empty the funnel with the help of a brush (C5) as described in section "14.8 Cleaning the pre-ground coffee funnel".
INSERT INFUSER ASSEMBLY	The infuser (A12) has not been replaced after cleaning.	Insert the infuser as described in section "14.9 Cleaning the infuser".

INSERT TANK	The tank (A10) is not correctly in place.	Insert the tank correctly and press as far as it will go.
GENERAL ALARM	The inside of the appliance is very dirty.	Clean the inside of the appliance thoroughly, as described in section "14. Cleaning". If the message is still displayed after cleaning, contact a service centre.
REPLACE FILTER	The water softener filter (C4) is exhausted.	Replace the filter or remove it as described in section "17. Water softener filter".
SET DIAL TO CLEAN	Milk has been delivered recently and the tubes inside the milk container must be cleaned.	Turn the froth adjustment dial (D1) to the CLEAN position.
INSERT WATER SPOUT	The hot water spout is not inserted or is inserted incorrectly.	Insert the water spout (C6) as far as it will go.
WATER CIRCUIT EMPTY FILL WATER CIRCUIT <i>alternating with...</i> HOT WATER PRESS OK	The water circuit is empty.	Press OK to deliver water from the hot water spout (C6) until it flows out normally. If the problem persists, make sure the water tank (A10) is fully inserted.
INSERT MILK CONTAINER	The milk container (D) is not inserted correctly.	Insert the milk container (fig. 13) as far as it will go.

21. TROUBLESHOOTING

Below is a list of some of the possible malfunctions.

If the problem cannot be resolved as described, contact Customer Services.

PROBLEM	POSSIBLE CAUSE	SOLUTION
The coffee is not hot.	The cups were not preheated.	Warm the cups by rinsing them with hot water (Please note: you can use the hot water function).
	The internal circuits have cooled down because 2/3 minutes have elapsed since the last coffee was made.	Before making coffee, heat the internal circuits by using the  rinse function (see section "9. Rinsing").
	A low coffee temperature is set.	Set a high coffee temperature in the menu.
The coffee is weak or not creamy enough.	The coffee is ground too coarsely.	Turn the grinding adjustment dial (A2) one click anticlockwise towards "1" while the coffee mill is in operation (fig. 8). Continue one click at a time until coffee delivery is satisfactory. The effect is only visible after delivering 2 coffees (see section "10.3 Adjusting the coffee mill").
	The coffee is unsuitable.	Use pre-ground coffee for espresso machines.

The coffee is delivered too slowly or a drop at a time.	The coffee is ground too finely.	Turn the grinding adjustment dial (A2) one click clockwise towards "7" while the coffee mill is in operation (fig. 10). Continue one click at a time until coffee delivery is satisfactory. The effect is only visible after delivering 2 coffees (see section "10.3 Adjusting the coffee mill").
Coffee does not come out of one or both of the spouts.	The coffee spouts (A13) are blocked.	Clean the spouts with a toothpick.
Milk is not delivered from the milk spout.	Milk is not delivered from the milk spout The milk container lid (D2) is dirty.	Clean the milk container lid as described in section "14.10 Cleaning the milk container".
The milk contains large bubbles and squirts out of the milk spout or there is little froth.	The milk is not sufficiently cold or semi-skimmed.	Use skimmed or semi-skimmed milk at refrigerator temperature (about 5° C). If the result is not as you wished, try changing brand of milk.
	The froth adjustment dial (D1) is incorrectly adjusted.	Adjust according to the instructions in section "11.2 Adjusting the amount of froth"
	The milk container lid (D2) or froth adjustment dial (D1) is dirty.	Clean the milk container lid and dial as described in section "14.10 Cleaning the milk container".
	The hot water/steam connection nozzle (A19) is dirty.	Clean the connection nozzle as described in section "14.11 Cleaning the hot water/steam connection nozzle".
The appliance does not come on.	It is not plugged into the mains socket.	Plug into the mains socket.
	The main switch (A8) is not turned on.	Press the main switch (fig. 1).
The infuser cannot be extracted .	The appliance has not been turned off correctly.	Turn the appliance off by pressing the  button (see section "7. Turning the appliance off").

22. ELECTRICAL CONNECTION (UK ONLY)

Before using this appliance ensure that the voltage indicated on the product corresponds with the main voltage in your home, if you are in any doubt about your supply contact your local electricity company.

The flexible mains lead is supplied connected to a B.S. 1363 fused plug having a fuse of 13 amp capacity.

Should this plug not fit the socket outlets in your home, it should be cut off and replaced with a suitable plug, following the procedure outlined below.

Note: Such a plug cannot be used for any other appliance and should therefore be properly disposed of and not left where children might find it and plug it into a supply socket - with the obvious consequent danger.

Please note: We recommend the use of good quality plugs and wall sockets that can be switched off when the machine is not in use.

IMPORTANT: The wires in the mains lead fitted to this appliance are coloured in accordance with the following code:

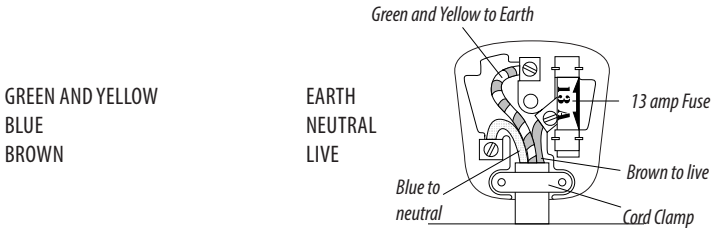

As the colours of the wires in the mains lead of this appliance may not correspond with the coloured markings identifying the terminals in your plug, proceed as follows:

- The wire which is coloured green and yellow must be connected to the terminal in the plug which is marked with the letter E or by the earth symbol  or coloured green or green and yellow.
- The wire which is coloured blue must be connected to the terminal which is marked with the letter N or coloured black.
- The wire which is coloured brown must be connected to the terminal which is marked with the letter L or coloured red.

When wiring the plug, ensure that all strands of wire are securely retained in each terminal. Do not forget to tighten the mains lead clamp on the plug. If your electricity supply point has only two pin socket outlets, or if you are in doubt, consult a qualified electrician. Should the mains lead ever require replacement, it is essential that this operation be carried out by a qualified electrician and should only be replaced with a flexible cord of the same size.

After replacement of a fuse in the plug, the fuse cover must be refitted. If the fuse cover is lost, the plug must not be used until a replacement cover is obtained. The colour of the correct replacement fuse cover is that of the coloured insert in the base of the fuse recess or elsewhere on the plug. Always state this colour when ordering a replacement fuse cover.

Only 13amp replacement fuses which are asta approved to B.S. 1362 should be fitted.

This appliance conforms to the Norms EN 55014 regarding the suppression of radio interference.

Warning - this appliance must be earthed