



De'Longhi Appliances
via Seitz, 47
31100 Treviso Italia

BEAN TO CUP ESPRESSO AND CAPPUCCINO MACHINE

Instruction for use

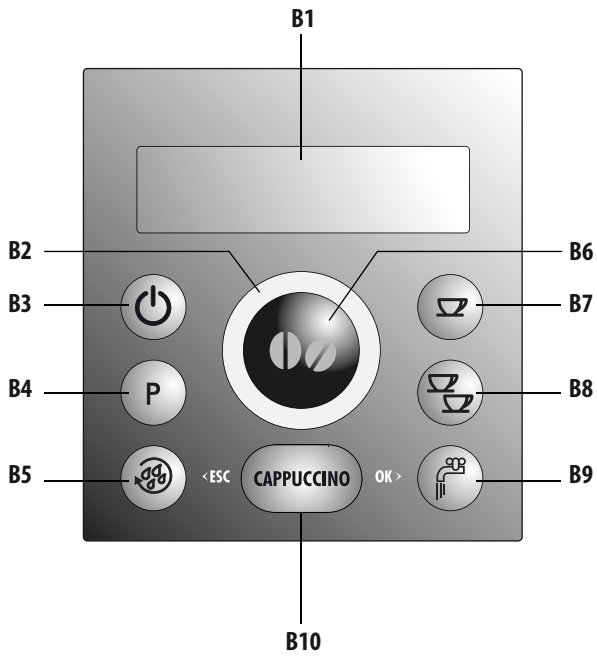
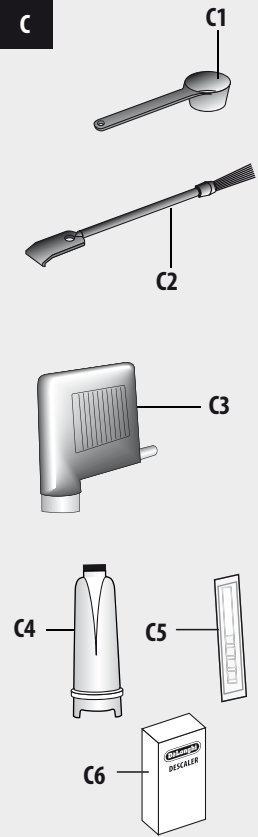
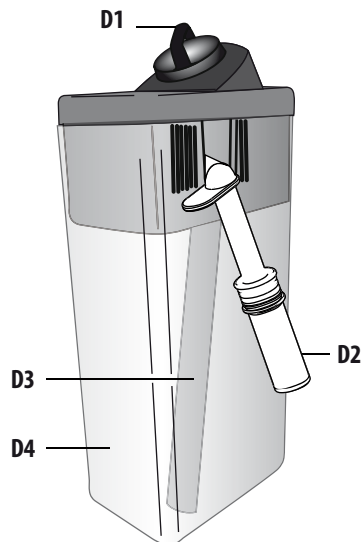

ECAM23.460

B**C****D**

A

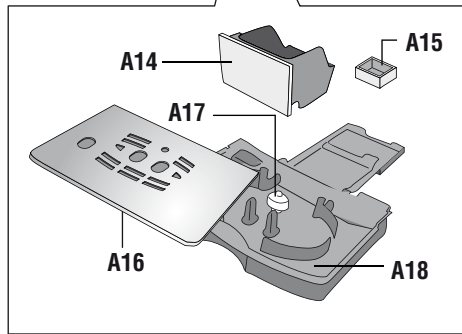
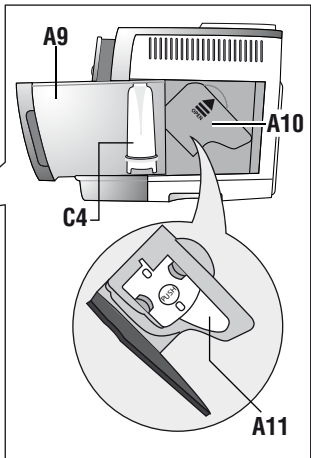
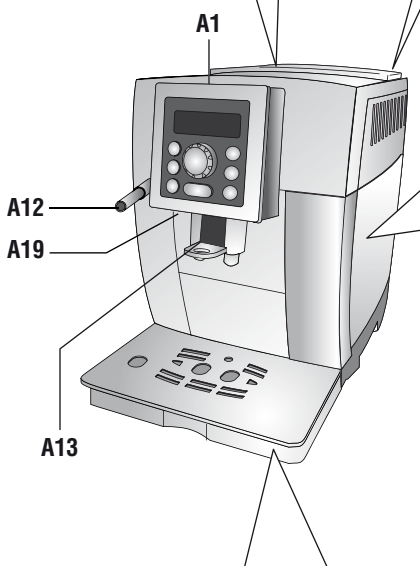
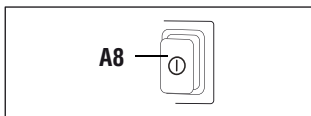
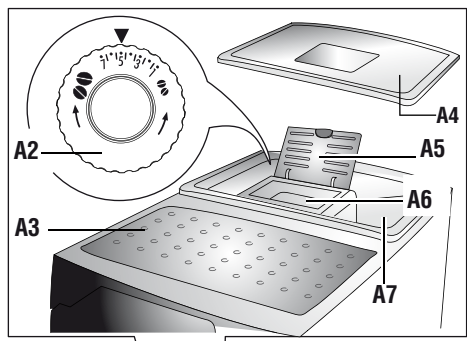

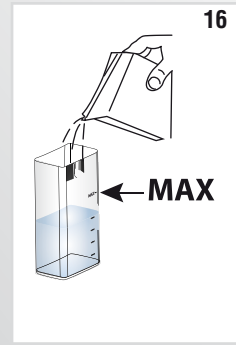
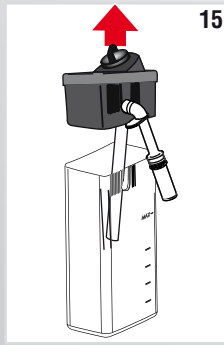
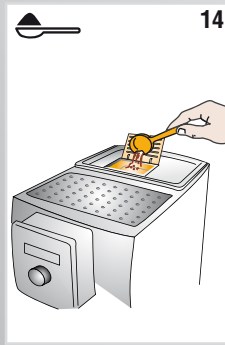
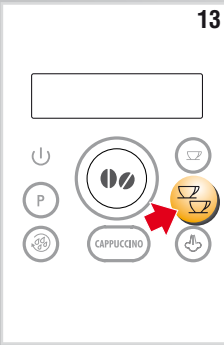
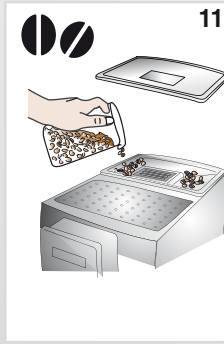
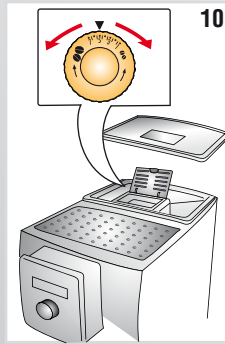
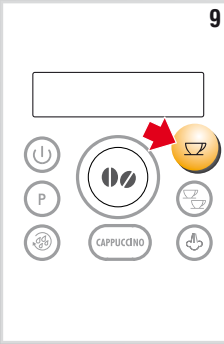
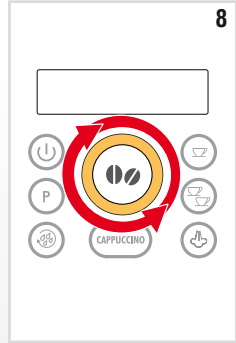
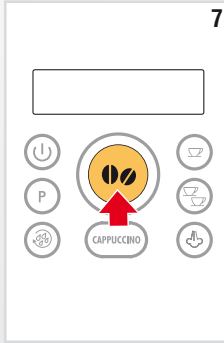
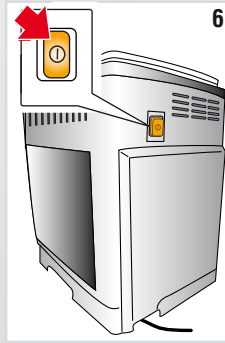
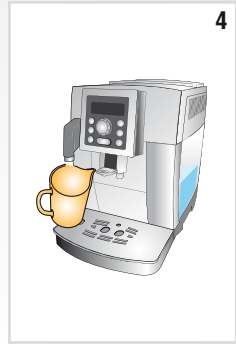
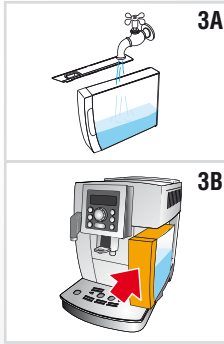
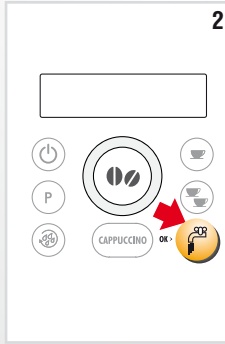
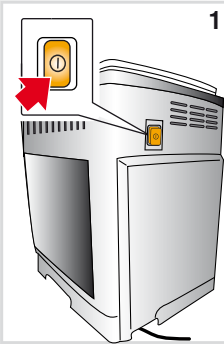

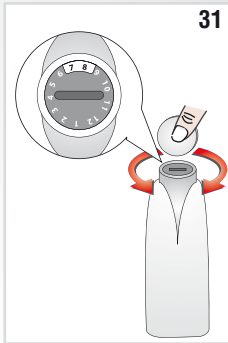
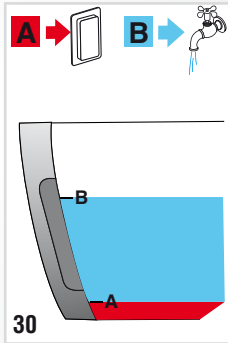
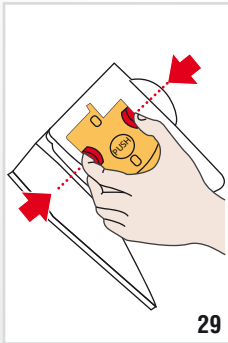
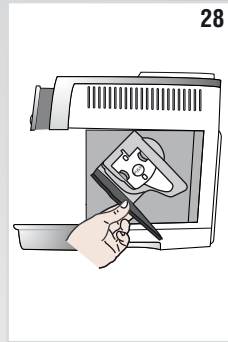
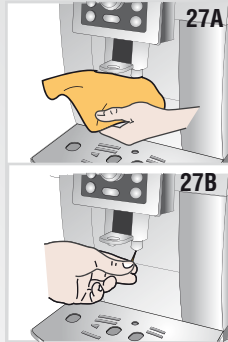
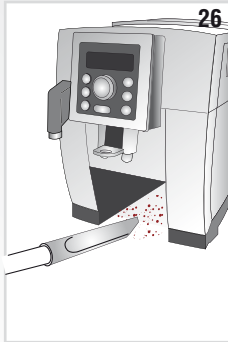
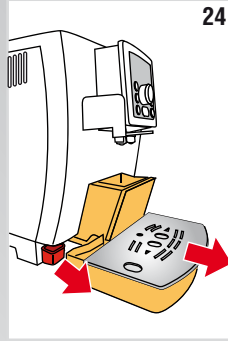
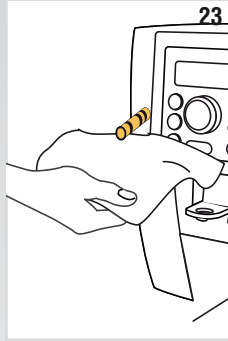
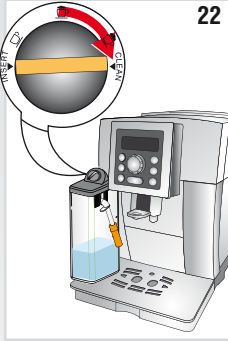
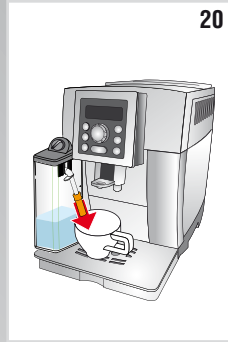
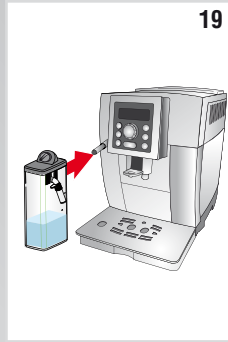
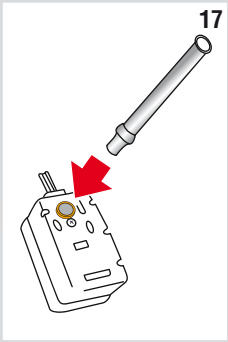

CONTENTS

INTRODUCTION	7
Symbols used in these instructions	7
Letters in brackets	7
Troubleshooting and repairs	7
SAFETY	7
Fundamental safety warnings.....	7
DESIGNATED USE	7
INSTRUCTION FOR USE	7
DESCRIPTION	8
Description of the appliance	8
Description of the control panel	8
Description of the accessories	8
Description of the milk container	8
BEFORE USE	8
Checking the appliance	8
Installing the appliance	8
Connecting the appliance	8
TURNING THE APPLIANCE ON	9
TURNING THE APPLIANCE OFF	9
MENU SETTINGS	9
Descaling	9
Install filter	9
Replacing the filter	10
Adjust time	10
Auto-start	10
Auto-Off.....	10
Energy saving.....	10
Setting the temperature	10
Setting water hardness	10
Enable/disable the beep	11
Setting the language	11
Cup light	11
Default values (reset).....	11
Statistics function	11
MAKING COFFEE	11
Selecting the coffee taste.....	11
Selecting the quantity of coffee in the cup	11
Customising the “my coffee” quantity	12
Adjusting the coffee mill	12
Tips for a hotter coffee	12
Making coffee using coffee beans	12
Making coffee using pre-ground coffee	12
MAKING CAPPUCCINOS AND MILK BASED COFFEES...	13
Filling and attaching the milk container	13
Adjusting the amount of froth	13
Making cappuccino or macchiato	13
Making frothed milk (without coffee)	13
Preparing milk (unfrothed and without coffee)	13
Cleaning the milk frother using the CLEAN function	14
Programming the quantity of coffee and milk in the cup for cappuccino or milk.....	14
HOT WATER	14
Changing the quantity of water delivered automatically.....	14
CLEANING	14
Cleaning the coffee grounds container.....	14
Cleaning the drip tray and condensate tray.....	15
Cleaning the inside of the coffee machine	15
Cleaning the water tank.....	15
Cleaning the coffee spouts.....	15
Cleaning the pre-ground coffee funnel	15
Cleaning the infuser.....	15
Cleaning the milk container	16
Cleaning the hot water/steam connection nozzle	16
DESCALING	16
SETTING WATER HARDNESS	17
Measuring water hardness.....	17
Setting water hardness	17
WATER SOFTENER FILTER	17
Installing the filter	17
Replacing the filter	18
Removing the filter	18
TECHNICAL DATA	18
DISPOSAL	18
DISPLAYED MESSAGES	19
TROUBLESHOOTING	20

INTRODUCTION

Thank you for choosing this automatic espresso and cappuccino machine. We hope you enjoy using your new appliance. Take a few minutes to read this Instruction for Use. This will avoid all risks and damage to the appliance.

Symbols used in these instructions

Important warnings are identified by these symbols. It is vital to respect these warnings.



Failure to observe the warning may result in life threatening injury by electric shock.



Failure to observe the warning could result in injury or damage to the appliance.



Failure to observe the warning could result in burns.



This symbol identifies important advice or information for the user.

Letters in brackets

The letters in brackets refer to the legend in the Description of the Appliance on pages 2 and 3.

Troubleshooting and repairs

In the event of problems, first try and resolve them following the information given in the sections "Displayed messages" on page 19 and "Troubleshooting" on page 20.

If this does not resolve the problem or you require further information, you should consult Customer Services by calling the number given on the annexed "Customer Service" sheet.

If your country is not among those listed on the sheet, call the number given in the guarantee. If repairs are required, contact De'Longhi Customer Services only. The addresses are given in the guarantee certificate provided with the machine.

SAFETY

Fundamental safety warnings



This is an electrical appliance and may cause electric shock. You should therefore follow these safety warnings:

- Never touch the appliance with damp hands or feet.
- Never touch the plug with damp hands.
- Make sure the socket used is freely accessible at all times, enabling the appliance to be unplugged when necessary.

- Unplug directly from the plug only. Never pull the power cable as you could damage it.
- To disconnect the appliance completely, place the main switch at the back of the appliance in the 0 position (fig. 6).
- If the appliance is faulty, do not attempt to repair. Turn it off, unplug from the mains socket and contact Customer Services.
- If the plug or power cable is damaged, it must be replaced by De'Longhi Customer Services only to avoid all risk.



- Keep all packaging (plastic bags, polystyrene foam) away from children.
- The appliance is not intended for use by persons (including children) with reduced physical, sensory or mental capabilities, or lack of experience and knowledge, unless they have been given supervision or instruction concerning use of the appliance by a person responsible for their safety. Children should be supervised to ensure that they do not play with the appliance.



This appliance produces hot water and steam may form while it is in operation.

Avoid contact with splashes of water or hot steam.

DESIGNATED USE

This appliance is designed and made to prepare coffee and heat drinks. All other use is considered improper.

This appliance is not suitable for commercial use.

The manufacturer is not liable for damage deriving from improper use of the appliance.

This is a household appliance only.

It is not intended to be used in:

- staff kitchen areas in shops, offices and other working environments;
- farm houses;
- by clients in hotels, motels and other residential type environments;
- bed and breakfast type environments.

INSTRUCTION FOR USE

Read these instructions carefully before using the appliance.

- Failure to respect these instructions may result in burns or damage to the appliance.

The manufacturer is not liable for damage deriving from failure to respect this Instruction for Use.



Keep this Instruction for Use.

If the appliance is passed to other persons, they must also be provided with this Instruction for Use.

DESCRIPTION

Description of the appliance







(page 3 - A)

- A1. Control panel
- A2. Grinding adjustment dial
- A3. Cup shelf
- A4. Beans container lid
- A5. Pre-ground coffee funnel lid
- A6. Pre-ground coffee funnel
- A7. Beans container
- A8. Main switch
- A9. Water tank
- A10. Infuser door
- A11. Infuser
- A12. Hot water and steam connection nozzle
- A13. Coffee spout (adjustable height)
- A14. Coffee grounds container
- A15. Condensate tray
- A16. Cup tray
- A17. Drip tray water level indicator
- A18. Drip tray
- A19. Cup light

Description of the control panel

(page 2 - B)

A number of buttons on the panel have a double function. This is indicated in brackets in the description.

- B1. Display: guides the user in using the appliance.
- B2. Selection dial: turn to select the required quantity of coffee. *(When in the settings MENU, turn to select the required function).*
- B3.  button: turns the appliance on and off.
- B4.  button to access the menu.
- B5.  button: to perform a rinse cycle. *(When in the settings MENU, it acts as the "ESC" button to exit from the selected function and go back to the main menu).*
- B6.  aroma selection button: press to select coffee taste.
- B7.  button: to make 1 cup of coffee with the settings displayed
- B8.  button: to make 2 cups of coffee with the settings displayed
- B9.  button: to deliver hot water *(When you access the MENU: "OK" button to confirm the selection made)*
- B10. CAPPUCCINO button: to prepare cappuccino or frothed milk.

Description of the accessories

(page 2 - C)

- C1. Pre-ground coffee measure
- C2. Cleaning brush
- C3. Hot water spout
- C4. Water softener filter (certain models only)
- C5. Indicator paper
- C6. Descaler

Description of the milk container

(page 3 - D)

- D1. Froth adjustment and CLEAN dial
- D2. Frothed milk spout (adjustable)
- D3. Milk intake tube
- D4. Milk container

BEFORE USE

Checking the appliance

After removing the packaging, make sure the product is complete and undamaged and that all accessories are present. Do not use the appliance if it is visibly damaged. Contact De'Longhi Customer Services.

Installing the appliance



Important!

When you install the appliance, you should respect the following safety warnings:

- The appliance gives off heat. After positioning the appliance on the worktop, leave a space of at least 3 cm between the surfaces of the appliance and the side and rear walls and at least 15 cm above the coffee machine.
- Water penetrating the appliance could cause damage. Do not place the appliance near taps or sinks.
- The appliance could be damaged if the water it contains freezes. Do not install the appliance in a room where the temperature could drop below freezing point.
- Arrange the power cable in such a way that it cannot be damaged by sharp edges or contact with hot surfaces (e.g. electric hot plates).

Connecting the appliance



Important!

Check that the mains power supply voltage corresponds to the value indicated on the rating plate on the bottom of the appliance.

Connect the appliance to an efficiently earthed and correctly installed socket with a minimum current rating of 10A only.

If the power socket does not match the plug on the appliance, have the socket replaced with a suitable type by a qualified professional.

Setting up the appliance



Please note:

- Coffee has been used to factory test the appliance and it is therefore completely normal for there to be traces of coffee in the mill. The machine is, however, guaranteed to be new.
 - You should customise water hardness as soon as possible following the Instruction for use in the section "Setting water hardness" on page 10.
1. Plug the appliance into the mains socket and make sure the main switch on the back of the appliance is in the I position (fig. 1).

You must first choose the language by turning the selection dial, or waiting until the languages scroll through on the display at intervals of about 3 seconds:

2. When "English" appears, press the  button (fig. 2) for a few seconds until "English set" is displayed.

Follow the instructions indicated on the appliance display:

3. "FILL TANK": extract the water tank, fill to the MAX line with fresh water (fig. 3A), then put back in the appliance (fig. 3B).
4. "INSERT WATER SPOUT": Check that the hot water spout is inserted on the connection nozzle and place a container holding a minimum of 500 ml underneath (fig. 4).
5. "HOT WATER Confirm?" is displayed;
6. Press the  button to confirm (fig. 2). The appliance delivers water from the spout then goes off automatically.

The coffee machine is now ready for normal use.



Please note:

- When using the appliance for the first time, you need to make 4-5 cups of coffee or 4-5 cappuccinos before it starts to give satisfactory results.
- When making the first 5-6 cappuccinos, it is normal to hear the noise of boiling water. After this, the noise becomes less.
- To enjoy your coffee even more and improve the performance of your appliance, we recommend installing a water softener filter as described in the section "INSTALL FILTER". If your model is not provided with a filter, you can request one from De'Longhi Customer Services.

TURNING THE APPLIANCE ON



Please note:

Before turning the appliance on, make sure the main switch on the back of the appliance is in the I position (fig. 1).

Each time the appliance is turned on, it performs an automatic preheat and rinse cycle which cannot be interrupted.

The appliance is ready for use only after completion of this cycle.



Danger of burns!

During rinsing, a little hot water comes out of the coffee spouts and is collected in the drip tray underneath.

Avoid contact with splashes of water.

- To turn the appliance on, press the  button (fig. 5). The message "Heating up Please wait" is displayed.

After heating, the message "Rinsing" is displayed. As well as heating the boiler, the appliance also heats the internal circuits by circulating hot water.

The appliance is at temperature when the message indicating the taste and quantity of coffee appears.

TURNING THE APPLIANCE OFF

Whenever the coffee machine is turned off after being used to make coffee, it performs an automatic rinse cycle.



Danger of burns!

During rinsing, a little hot water flows from the coffee spouts.

Avoid contact with splashes of water.

To turn the appliance off, press the  button (fig. 5). The appliance performs a rinse cycle, then the message "Turning off Please wait" is displayed and the appliance goes off (standby).



Please note!

If you will not be using the appliance for some time, unplug from the mains socket:

- first turn the appliance off by pressing the  button (fig. 8);
- release the main switch at the side of the appliance (fig. 2).



Important!

Never press the main switch while the appliance is on.

MENU SETTINGS

When you access the settings menu by pressing the P button, the following menu items can be selected:

Descaling

For instructions on descaling, see page 16.

Install filter



For instructions on how to install the filter, see the section "Installing the filter (page 17).

Replacing the filter

For instructions on how to replace the filter, see the section "Replacing the filter" (page 18).

Adjust time

To adjust the time on the display, proceed as follows:

1. Press the **P** button to enter the menu;
2. Turn the selection dial (fig. 8) until "Adjust time" is displayed;
3. Press the  button (fig. 2).
4. Turn the selection dial (fig. 8) to change the hours;
5. Press the  button to confirm;
6. Turn the selection dial (fig. 8) to change the minutes;
7. Press the  button to confirm.

This sets the time. Press the  button to exit the menu.





Auto-start

You can set the auto-start time in order to have the appliance ready at a certain time (for example in the morning) so you can make coffee immediately.

 *Please note:*

To enable this function, the time must already be set correctly.

To enable auto-start, proceed as follows:

1. Press the **P** button to enter the menu;
2. Turn the selection dial (fig. 8) until "Auto-start" is displayed;
3. Press the  button. "Enable?" is displayed;
4. Press the  button to confirm;
5. Turn the selection dial to choose the hours;
6. Press the  button to confirm;
7. Turn the selection dial (fig. 8) to change the minutes;
8. Press the  button to confirm;
9. Then press the  button to exit the menu.

Once the time has been confirmed, activation of auto-start is indicated by the  symbol displayed alongside the time and under "Auto-start" in the menu.

To disable the function:

1. Select auto-start from the menu;
2. Press the  button. "Disable?" is displayed;
3. Press the  button to confirm.



The  symbol is no longer displayed.

Auto-Off

The time can be changed so that the appliance switches off after 15 or 30 minutes, or after 1, 2 or 3 hours.

To re-programme Auto-off, proceed as follows:

1. Press the **P** button to enter the menu;
2. Turn the selection dial (fig. 8) until "Auto-off" is displayed;
3. Press the  button;

4. Turn the selection dial (fig. 8) until the required operating time (15 or 30 minutes, or 1, 2 or 3 hours) is displayed;
5. Press the  button to confirm;
6. Then press the  button to exit the menu. Auto-off is programmed.



Energy saving

Use this function to enable or disable energy saving.

When enabled, the function reduces energy consumption in compliance with European regulations.

When energy saving mode is active, an asterisk appears under "Energy saving" in the menu.

To enable or disable energy saving, proceed as follows:

1. Press the **P** button to enter the menu;
2. Turn the selection dial (fig. 8) until "Energy saving" is displayed;
3. Press the  button. "Disable?" is displayed (or "Enable?" if the function has already been disabled);
4. Press the  button to disable energy saving mode;
5. Then press the  button to exit the menu.



When the function is active, if the machine is not used for some time, "Energy saving" is displayed.

 *Please note!*

- When in energy saving mode, a few seconds elapse before the first coffee, cappuccino or milk based coffee is delivered as the appliance must heat up again.
- To prepare any drink, press any button to exit energy saving, then press the button corresponding to the drink you want to make.
- If the milk container is inserted, "Energy saving" is not activated.

Setting the temperature

To modify the temperature of the water used to make the coffee, proceed as follows:

1. Press the **P** button to enter the menu;
2. Turn the selection dial (fig. 8) until "Set temperature" is displayed;
3. Press the  button;
4. Turn the selection dial until the required temperature (●=low; ●●●●=high) is displayed;
5. Press the  button to confirm;
6. Then press the  button to exit the menu.



Setting water hardness

For instructions on setting water hardness, see page 17.

Enable/disable the beep



This enables or disables the beep emitted by the machine each time the buttons are pressed or an accessory is inserted/removed. The beep is active by default.

To disable or re-enable the beep, proceed as follows:

1. Press the **P** button to enter the menu;
2. Turn the selection dial (fig. 8) until "Beep" is displayed;
3. Press the  button. "Disable?" or "Enable?" is displayed;
4. Press the  button to enable or disable the beep;
5. Activation of the beep is indicated by an asterisk below the "Beep" item in the menu. Press the  button to exit the menu.

Setting the language

To modify the language of the display, proceed as follows:



1. Press the **P** button to enter the menu;
2. Turn the selection dial (fig. 8) until "Set language" is displayed;
3. Press the  button;
4. Turn the selection dial until the required language is displayed;
5. Press the  button to confirm;
6. A message confirming the language installed is displayed;
7. Then press the  button to exit the menu.

Cup light

This function enables or disables the cup lights. The lights are enabled by default.

The lights come on each time coffee and cappuccino is made and during each rinsing cycle.



To disable or re-enable this function, proceed as follows:

1. Press the **P** button to enter the menu;
2. Turn the selection dial (fig. 8) until "Cup lighting" is displayed;
3. Press the  button. "Disable?" or "Enable?" is displayed;
4. Press the  button to enable or disable the cup lighting;
5. When the function is active, an asterisk appears under "Cup lighting" in the menu. Press the  button to exit the menu.

Default values (reset)

This resets all menu settings and programmed quantities back to the default values (with the exception of the language which remains as set).



To reset the default values, proceed as follows:

1. Press the **P** button to enter the menu;
2. Turn the selection dial (fig. 8) until "Default values" is displayed;
3. Press the  button;
4. "Confirm?" is displayed;
5. Press the  button to confirm and exit.

Statistics function

This displays statistics relating to the machine.

To display, proceed as follows:

1. Press the **P** button to enter the menu;
2. Turn the selection dial (fig. 8) until "Statistics" is displayed;
3. Press the  button;
4. Turn the selection dial (fig. 8) to verify:
 - how many coffees have been made;
 - the total number of cappuccinos and milk based coffees made;
 - the total number of litres of water delivered;
 - how many times the machine has been descaled;
 - how many times the water softener filter has been replaced.
5. Press the  button twice to exit the menu.

MAKING COFFEE

Selecting the coffee taste

The appliance is set by default to make coffee with a standard taste. You can also choose one of these tastes:

Extra-mild taste

Mild taste

Standard taste

Strong taste

Extra-strong taste

To change the taste, press the  dial (fig. 7) repeatedly until the required taste is displayed.

Selecting the quantity of coffee in the cup



The appliance is set by default to make a standard quantity of coffee. To select the quantity of coffee, turn the selection dial (fig. 8) until the message corresponding to the required quantity of coffee is displayed:

Coffee selected	Quantity in cup (ml)
MY COFFEE	Programmable: from ≈ 20 to ≈ 180
SHORT	≈ 40
STANDARD	≈ 60

LONG	≈90
EXTRA LONG COFFEE	≈120

Customising the “my coffee” quantity

The appliance is set by default to automatically deliver 30 ml of “MY COFFEE”. To modify this quantity, proceed as follows:

1. Place a cup under the coffee spouts (fig. 12).
2. Turn the selection dial (fig. 8) until “MY COFFEE” is displayed.
3. Keep the  button (fig. 9) pressed until the message “1 MY COFFEE Program quantity” is displayed and coffee delivery begins. Release the button.
4. As soon as the coffee in the cup reaches the required level, press the  button (fig. 9) again.

The quantity of coffee in the cup set has now been programmed.

Adjusting the coffee mill

The coffee mill is set by default to prepare coffee correctly and should not require regulating initially.

However, if after making the first few coffees you find that the coffee is either too weak and not creamy enough or delivery is too slow (a drop at a time), this can be corrected by adjusting the grinding adjustment dial (fig. 10).



Please note:

The grinding adjustment dial must only be turned when the coffee mill is in operation.

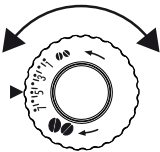

If the coffee is delivered too slowly or not at all, turn one click clockwise towards “7”. For fuller bodied creamier coffee, turn one click anticlockwise towards “1” (do not turn more than one click at a time otherwise the coffee could be delivered a drop at a

time). These adjustments will only be evident after at least 2 cups of coffee have been delivered. If this adjustment does not obtain the desired result, turn the dial another click.

Tips for a hotter coffee

For hotter coffee, you should:



- before delivering the coffee, perform a rinse cycle by pressing the  button. Hot water is delivered from the spout, heating the internal circuits of the appliance and thus raising the coffee temperature;
- warm the cups by rinsing them with hot water (using the hot water function);
- select the “high” coffee temperature in the menu.

Making coffee using coffee beans





Important!

Do not use caramelised or candied coffee beans as they could stick to the coffee mill and make it unusable.

1. Fill the container with coffee beans (fig. 11).
2. Place under the coffee spouts:
 - 1 cup, if you want to make 1 coffee (fig. 12);
 - 2 cups if you want 2 coffees.
3. Lower the spout as near as possible to the cups. This makes a creamier coffee (fig. 12).
4. Press the button corresponding to the number of coffees required (1 cup  or 2 cups ) (figs. 9 and 13).
5. Preparation begins. The amount of coffee selected is displayed together with a progress bar which gradually fills as preparation progresses.



Please note:

- While the machine is making coffee, delivery can be interrupted at any moment by pressing any button.
- At the end of delivery, to increase the quantity of coffee in the cup, just press (within 3 seconds) one of the coffee buttons ( or ).

Once the coffee has been made, the appliance is ready to make the next drink.



Please note:

- Various alarm messages could be displayed while using the machine (FILL TANK, EMPTY GROUNDS CONTAINER, etc.). Their meaning is explained in the section “Displayed messages” (page 19).
- For hotter coffee, see the section “Tips for a hotter coffee” (page 12).
- If the coffee is delivered a drop at a time, too weak and not creamy enough or too cold, read the tips in the “Troubleshooting” section on page 20.

Making coffee using pre-ground coffee





Important!

- Never add pre-ground coffee when the machine is off or it could spread through the inside of the machine and dirty it. This could damage the appliance.
- Never use more than one level measure or it could dirty the inside of the machine or block the funnel.



Please note:

If you use pre-ground coffee, you can only make one cup of coffee at a time.

1. Press the  button (fig. 7) repeatedly until "Pre-ground" is displayed.
2. Make sure the funnel is not blocked, then add one level measure of pre-ground coffee (fig. 14).
3. Place a cup under the coffee spouts.
4. Press the 1 cup  button (fig. 9).
5. Preparation begins. The amount of coffee selected is displayed together with a progress bar which gradually fills as preparation progresses.



Please note:

If "energy saving" mode is active, you may have to wait a few seconds before the first coffee is delivered.

MAKING CAPPUCCINOS AND MILK BASED COFFEES



Please note:

- To avoid producing milk with poor froth or large bubbles, always clean the milk container lid and hot water connection nozzle as described in the section "Cleaning the milk container" on pages 14 and 16.

Filling and attaching the milk container

1. Remove the lid (fig. 15);
2. Fill the milk container with a sufficient quantity of milk, not exceeding the MAX level marked on the handle (fig. 16). Each mark on the side of the container corresponds to 100 ml of milk.





Please note:

- For a denser more even froth, you must use skimmed or partially skimmed milk at refrigerator temperature (about 5°C).
 - If "energy saving" mode is enabled, you may have to wait a few seconds before the first cappuccino is delivered.
3. Make sure the milk intake tube is correctly inserted in the bottom of the milk container lid (fig. 17).
 4. Place the lid back on the milk container.
 5. Remove the hot water spout from the connection nozzle (fig. 18).
 6. Attach the container to the connection nozzle and push as far as it will go (fig. 19). The machine emits a beep.
 7. Place a sufficiently large cup under the coffee and frothed milk spouts. Adjust the length of the milk spout. To move it nearer the cup, simply pull it downwards (fig. 20).
 8. Follow the instructions below for each function.

Adjusting the amount of froth

Turn the froth adjustment dial to adjust the amount of froth on the milk delivered while making cappuccino and milk based coffees.

Dial position	Description	Recommended for...
	No froth	HOT MILK
	Min. froth	CAPPUCCINO / LATTE MACCHIATO / LATTE SCHIUMATO
	Max. froth	

Making cappuccino or macchiato

1. After attaching the milk container, turn the froth regulator on the milk container lid to the required position (fig. 21).
2. Press the CAPPUCCINO button. "CAPPUCCINO" is displayed, together with a progress bar which fills gradually as preparation proceeds.
3. After delivering the milk, the machine automatically makes the coffee.



Please note:

- If during delivery you want to stop preparation, press the CAPPUCCINO button twice.
- At the end of delivery, to increase the quantity of milk or coffee in the cup, within 3 seconds, press and hold the CAPPUCCINO button.
- Do not leave the milk container out of the refrigerator for long periods. The warmer the milk (5°C is ideal), the poorer the quality of froth produced.

Making frothed milk (without coffee)

Proceed as described in the previous paragraph (Making cappuccino or macchiato), pressing the CAPPUCCINO button twice instead of once.



Please note:

If during delivery you want to stop preparation, press the CAPPUCCINO button once.

Preparing milk (unfrothed and without coffee)

Proceed as described in the previous paragraph (Making frothed milk), turning the froth regulator to the  position.

Cleaning the milk frother using the CLEAN function



Important! Danger of burns

When cleaning the internal tubes of the milk container, a little hot water and steam leak out of the frothed milk spout.

Avoid contact with splashes of water.

“SET DIAL TO CLEAN” flashes on the display each time you use a milk function. To eliminate all milk residues, proceed as follows:

1. Leave the milk container in the machine (you do not need to empty it);
2. Place a cup or other recipient under the frothed milk spout.
3. Turn the froth adjustment dial to “CLEAN” (fig. 22). A progress bar appears and gradually fills as the operation proceeds together with “Cleaning underway, Please wait”. Cleaning stops automatically.
4. Turn the dial back to one of the froth selections.
5. Remove the milk container and always clean the steam connection nozzle with a sponge (fig. 26).



Please note!

- To prepare a number of cappuccinos or milk based coffees, clean the milk container after you have prepared the last drink only.
- The milk container can be kept in the refrigerator.
- In some cases, to clean you must wait for the appliance to heat up.

Programming the quantity of coffee and milk in the cup for cappuccino or milk

The appliance is set by default to automatically deliver standard quantities. To change these quantities, proceed as follows:

1. Place a cup under the coffee spouts and milk spout.
2. Press and hold the CAPPUCCINO button until the message “PROGRAM MILK Program quantity” is displayed.
3. Release the button. The appliance starts delivering milk.
4. Once the required quantity of milk has been delivered into the cup, press the CAPPUCCINO button again.
5. The appliance stops delivering milk and after a few seconds the coffee is delivered into the cup. “PROGRAM COFFEE Program quantity” is displayed.
6. Once the required quantity of coffee has been delivered into the cup, press the CAPPUCCINO button. Coffee delivery stops.



The machine is now reprogrammed with the new milk and coffee quantities.

HOT WATER



Important! Danger of burns.

Never leave the machine unsupervised while delivering hot water. The spout becomes hot during delivery. Hold by the handle only.

1. Make sure the hot water spout is attached correctly (fig. 4).
2. Place a container under the spout (as close as possible to avoid splashes).
3. Press the  button (fig. 2). “Hot water” is displayed, together with a progress bar which fills gradually as preparation proceeds.
4. The machine delivers about 250 ml of hot water, then delivery stops automatically. To interrupt delivery of hot water manually, press the  button again.





Please note:

If “energy saving” mode is active, you may have to wait a few seconds before the hot water is delivered.

Changing the quantity of water delivered automatically

The machine is set by default to automatically deliver 250 ml of hot water. To modify these quantities, proceed as follows:

1. Position a container under the spout.
2. Press and hold the  button until “HOT WATER Program quantity” is displayed, then release the  button.
3. When the hot water in the cup reaches the required level, press the  button again.

The machine is now reprogrammed with the new quantity.

CLEANING



Important!

- Do not use solvents, abrasive detergents or alcohol to clean the appliance. With De'Longhi superautomatic bean to cup espresso and cappuccino machines, you need not use chemical products to clean the machine.
- None of the components of the appliance can be washed in a dishwasher with the exception of the milk container (D).
- Do not use metal objects to remove encrustations or coffee deposits as they could scratch metal or plastic surfaces.

Cleaning the coffee grounds container

When “EMPTY GROUNDS CONTAINER” is displayed, the grounds container must be emptied and cleaned.

The appliance cannot be used to make coffee until you have cleaned the grounds container.

Even if not full, the empty grounds container message is displayed 72 hours after the first coffee has been prepared. For the 72 hours to be calculated correctly, the machine must never be turned off with the main switch in the 0 position.



Important! Danger of burns

If you make a number of cappuccinos one after the other, the metal cup tray becomes hot.

Wait for it to cool down before touching it and handle it from the front only.

To clean (with the machine on):

- Remove the drip tray (fig. 24), empty and clean.
- Empty the grounds container and clean thoroughly to remove all residues left on the bottom. This can be done with the spatula on the brush provided.
- Check the condensate tray and empty if necessary.



Important!

When removing the drip tray, the grounds container must be emptied, even if it contains few grounds.

If this is not done, when you make the next coffees, the grounds container may fill up more than expected and clog the machine.

Cleaning the drip tray and condensate tray



Important!

The drip tray is fitted with a level indicator (red) showing the level of water it contains (fig. 25).

Before the indicator protrudes from the cup tray, the drip tray must be emptied and cleaned, otherwise the water may overflow the edge and damage the appliance, the surface it rests on or the surrounding area.

To remove the drip tray:

1. Remove the drip tray and grounds container (fig. 24);
2. Empty the drip tray and grounds container and wash them;
3. Check the condensate tray and empty if necessary.
4. Replace the drip tray complete with grounds container.

Cleaning the inside of the coffee machine



Danger of electric shock!

Before cleaning internal parts, the machine must be turned off (see "Turning off") and unplugged from the mains power supply. Never immerse the coffee machine in water.

1. Check regularly (about once a week) that the inside of the appliance (accessible after removing the drip tray) is not

dirty. If necessary, remove coffee deposits with the brush supplied and a sponge.

2. Remove the residues with a vacuum cleaner (fig. 26).

Cleaning the water tank

1. Clean the water tank (A9) regularly (about once a month) and whenever you replace the water softener filter (if provided) with a damp cloth and a little mild washing up liquid.
2. Remove the filter (if present) and rinse with running water.
3. Replace the filter (if provided), fill the tank with fresh water and replace the tank.

Cleaning the coffee spouts

1. Clean the coffee spouts regularly with a sponge or cloth (fig. 27A).
2. Check the holes in the coffee spout are not blocked. If necessary, remove coffee deposits with a toothpick (fig. 27B).

Cleaning the pre-ground coffee funnel

Check regularly (about once a month) that the pre-ground coffee funnel (A6) is not blocked. If necessary, remove coffee deposits with the brush (C2) supplied.

Cleaning the infuser

The infuser (A11) must be cleaned at least once a month.



Important!

The infuser may not be extracted when the machine is on.

1. Make sure the machine is correctly turned off (see "Turning off", page 9).
2. Open the infuser door (fig. 28) on the right side of the appliance.
4. Press the two red release buttons inwards and at the same time pull the infuser outwards (fig. 29).
5. Soak the infuser in water for about 5 minutes, then rinse under the tap.



Important!

RINSE WITH WATER ONLY

NO WASHING UP LIQUID - NO DISH WASHER

Do not use washing up liquid to clean the infuser as it may damage it.

6. Use the brush (C2) to remove any coffee residues left in the infuser housing, visible through the infuser door.
7. After cleaning, replace the infuser by sliding it onto the internal support, then push the PUSH symbol fully in until it clicks into place.

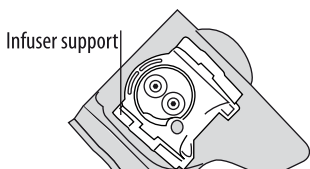

i Please note:

If the infuser is difficult to insert, before insertion, squeeze the two levers shown in the figure to make it smaller.

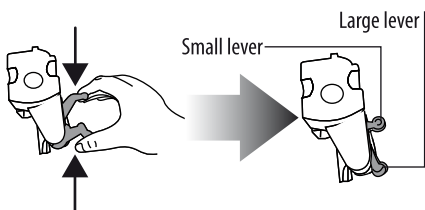

- Once inserted, make sure the two red buttons have snapped out.

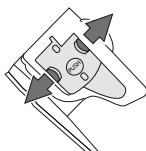

- Close the infuser door.
- Replace the water tank.

Cleaning the milk container

Clean the milk container each time you prepare milk as described below:

- Remove the lid.
- Remove the milk spout and intake tube.
- Turn the froth adjustment dial clockwise to the "INSERT" position (see figure) and pull off upwards.

- Wash all the components thoroughly with hot water and mild washing-up liquid. All components are dishwasher safe, placing them in the top basket of the dishwasher. Make sure there are no milk residues on the hollow and groove under the dial (see figure alongside). If necessary, scrape the groove with a toothpick.

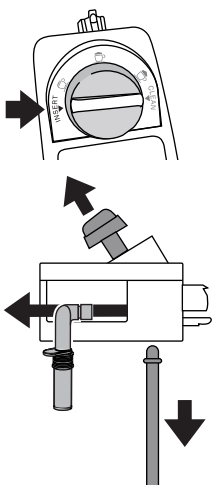

- Rinse inside the froth adjustment dial seat with running water (see figure)
- Check that the intake tube and spout are not clogged with milk residues.
- Replace the dial (in correspondence to the word "INSERT"), spout and milk intake tube.
- Place the lid back on the milk container.

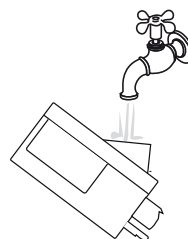
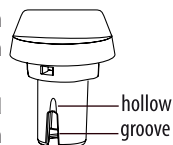

Cleaning the hot water/steam connection nozzle

Each time you prepare milk, clean the connection nozzle with a sponge to remove milk residues from the gaskets (fig. 23).

DESCALING

Descal the machine when the message "DESCALE" flashes on the display.

! Important!

- Descaler contains acids which may irritate the skin and eyes. It is vital to follow the manufacturer's safety warnings given on the descaler pack and the warnings relating to the procedure to follow in the event of contact with the skin and eyes.
- You should use De'Longhi descaler only. Using unsuitable descaler and/or performing descaling incorrectly may result in faults not covered by the manufacturer's guarantee.

- Turn the machine on.
- Press the **P** button to enter the menu.
- Turn the selection dial until "Descal" is displayed.
- Select by pressing the **OK** button: "Descal Confirm?" is displayed. Press **OK** again to enable the function.
- The message "Add descaler Confirm?" is displayed, alternating with "EMPTY THE DRIP TRAY" and "REMOVE FILTER" (if the filter is present).
- Empty the water tank (A9) completely and remove the water softener filter (if present). Empty the drip tray (fig. 24) and grounds container, then put them back in the appliance.
- Pour the descaler into the tank up to level **A** (corresponding to a 100 ml pack) marked on the side of the tank (fig. 30), then add water (1 litre) up to level **B** (fig. 30) and put the water tank back.

- Place an empty container with a minimum capacity of 1.5 litres under the hot water spout (fig. 4).



Important! *Danger di scottature*

Hot water containing acid flows out of the hot water spout.

Avoid contact with splashes of water.

- Press the button to confirm that you have added the solution.

The message "Descale underway" is displayed.

The descale programme starts and the descaler liquid comes out of the water spout.

The descale programme automatically performs a series of rinses and pauses to remove limescale deposits from inside the machine.

After about 30 minutes, the message "Rinsing""INSERT FILTER" (if present), "FILL TANK" is displayed.

- The appliance is now ready for rinsing through with clean water. Extract the water tank, empty, rinse under running water, fill with clean water up to the MAX level, insert the filter (if removed previously) and put the water tank back in the machine. "Rinsing Confirm?" is displayed.
- Empty the container used to collect the descaler solution and replace it empty under the cappuccino maker.
- Press the button to start rinsing. Hot water flows out of the spout and the message "Rinsing Please wait" is displayed.
- When the water tank is completely empty, the message "Rinsing complete Confirm?" is displayed.
- Press the button.
- "Heating up Please wait" is displayed, at the end of which the machine will be ready for use.

SETTING WATER HARDNESS

The DESCAL message is displayed after a period of time established according to water hardness.

The machine is set by default for a hardness value of 4.

The machine can also be programmed according to the hardness of the mains water in the various regions so that the machine needs to be descaled less often.

Measuring water hardness

- Remove the "TOTAL HARDNESS TEST" indicator paper from its pack (attached to the English instructions).
- Immerse the paper completely in a glass of water for one second.
- Remove the paper from the water and shake lightly. After about a minute, 1, 2, 3, or 4 red squares form, depending on the hardness of the water. Each square corresponds to one level.

soft water

slightly hard water

hard water

very hard water

Setting water hardness

- Press the **P** button to enter the menu.
- Turn the selection dial to select "Water hardness".
- Press the button to confirm the selection.
- Turn the selection dial and set the hardness level as measured by the indicator paper (see previous paragraph).
- Press the button to confirm the setting.
- Press the button to exit the menu.

The machine is now reprogrammed with the new water hardness setting.

WATER SOFTENER FILTER

Certain models are fitted with a water softener filter. If this is not the case with your model, you are recommended to purchase one from De'Longhi Customer Services.

To use the filter correctly, follow the instructions below.

Installing the filter

- Remove the filter from the packaging.
- Turn the date indicator disk (see fig. 31) until the next two months of use are displayed.



Please note

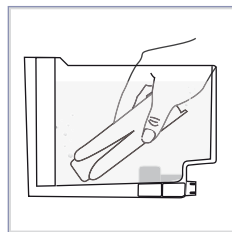

The filter lasts about two months if the appliance is used normally. If the coffee machine is left unused with the filter installed, it will last a maximum of three weeks.

- To activate the filter, run tap water through the hole in the filter as shown in the figure until water comes out of the openings at the side for more than a minute (fig. 32).
- Extract the tank from the appliance and fill with water.
- Insert the filter in the water tank and immerse it completely for about ten minutes, sloping it to enable the air bubbles to escape.
- Insert the filter in the filter housing and press as far as it will go.



- Close the tank with the lid, then put the tank back in the machine.

When you install the filter, you must notify the appliance of its presence.

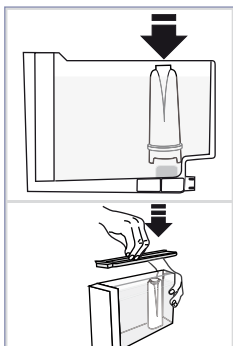

- Press the **P** button to enter the menu;
- Turn the selection dial (fig. 8) until "Install filter" is displayed;
- Press the  button;
- "Enable?" is displayed;
- Press the  button to confirm the selection. "Hot water Confirm?" is displayed;
- Position a container under the hot water spout (min. capacity: 500 ml);
- Press the  button to confirm the selection. The appliance begins hot water delivery and the message "Please wait" is displayed;
- After delivery, the appliance is automatically ready to make the next drink.



The new filter is active and indicated by an asterisk displayed under "Install filter" in the menu. You can now use the appliance.

Replacing the filter

When "Replace filter" is displayed, after two months (see date indicator) or when the appliance has not been used for 3 weeks, you should replace the filter:



- Extract the tank and exhausted filter;
- Take the new filter out of its packet and proceed as illustrated in points 2, 3, 4, 5 and 6 in the previous section.
- Position a container with a minimum capacity of 500 ml under the hot water spout.
- Press the **P** button to enter the menu.
- Turn the selection dial until "Replace filter" is displayed.
- Press the  button.
- "Confirm?" is displayed.
- Press the  button to confirm the selection;
- "Hot water Confirm?" is displayed;
- Press the  button to confirm the selection. The appliance begins hot water delivery and the message "Please wait" is displayed;
- After delivery, the appliance is automatically ready to make the next drink.

The new filter is now active and you can use the coffee machine.

Removing the filter

If you want to use the appliance without the filter, you must remove it and notify the appliance of its removal.

Proceed as follows:

- Extract the tank and exhausted filter;
- Press the **P** button to enter the menu;
- Turn the selection dial (fig. 8) until "Install filter*" is displayed;
- Press the  button;
- "Disable?" is displayed;
- Press the  button to confirm and the  button to exit the menu.

TECHNICAL DATA

Tensione:	220-240 V ~ 50/60 Hz max. 10A
Absorbed power:	1450W
Pressure:	15 bar
Max. water tank capacity:	1,8 l
Size LxHxD:	238x351x430 mm
Cable length:	1,75 m
Weight:	9,7 kg
Coffee beans container capacity:	250 g



The appliance complies with the following EC directives:



- European Stand-by Regulation 1275/2008;
- Low Voltage Directive 2006/95/EC and subsequent amendments;
- EMC Directive 2004/108/EC and subsequent amendments;
- Materials and accessories coming into contact with food conform to EC regulation 1935/2004.

DISPOSAL



In compliance with European directive 2002/96/EC, the appliance must not be disposed of with household waste, but taken to an authorised waste separation and recycling centre.

DISPLAYED MESSAGES

DISPLAYED MESSAGE	POSSIBLE CAUSE	SOLUTION
FILL TANK	Insufficient water in the tank.	Fill the tank with water and/or insert it correctly, pushing it as far as it will go until it clicks into place (fig. 3).
EMPTY GROUNDS CONTAINER	The grounds container (A14) is full.	Empty the grounds container and drip tray, clean and replace (fig. 23). Important: when removing the drip tray, the grounds container MUST be emptied, even if it contains few grounds. If this is not done, when you make the next coffees, the grounds container may fill up more than expected and clog the machine.
GROUND TOO FINE ADJUST MILL	The grinding is too fine and the coffee is delivered too slowly or not at all.	The grinding is too fine and the coffee is delivered too slowly or not at all. Repeat coffee delivery and turn the grinding adjustment dial (fig. 10) one click clockwise towards "7" while the coffee mill is in operation. If after making at least 2 coffees delivery is still too slow, repeat the correction procedure, turning the grinding adjustment dial another click until delivery is correct (see the section: "Adjusting the coffee mill" on page 12). If the problem persists, make sure the water tank is fully inserted, press the  button and deliver a little water from the spout.
INSERT GROUNDS CONTAINER	After cleaning, the grounds container has not been replaced.	Remove the drip tray and insert the grounds container.
ADD PRE-GROUND COFFEE	With the pre-ground function selected, pre-ground coffee has not been poured into the funnel.	Place pre-ground coffee in the funnel or deselect the "pre-ground" function (fig. 14).
DESCALE	The machine must be descaled.	The descaling procedure described in the section "Descaling" needs to be performed as soon as possible (page 16).
LESS COFFEE	Too much coffee has been used.	Select a milder taste by pressing the dial  (fig. 7) or reduce the quantity of pre-ground coffee.
FILL BEANS CONTAINER	The coffee beans have run out.	Fill the beans container (fig. 11).
	The pre-ground coffee funnel is clogged.	Empty the funnel with the help of a brush as described in the section "Cleaning the pre-ground coffee funnel".
INSERT INFUSER ASSEMBLY	The infuser has not been replaced after cleaning.	Insert the infuser as described in the paragraph "Cleaning the infuser".

INSERT TANK	The tank is not correctly in place.	Insert the tank correctly and press as far as it will go.
GENERAL ALARM	The inside of the appliance is very dirty.	Clean the inside of the appliance thoroughly, as described in the section "Cleaning and maintenance". If the message is still displayed after cleaning, contact a service centre.
REPLACE FILTER	The water softener filter is exhausted.	Replace the filter or remove it as described in the section "Water softener filter".
SET DIAL TO CLEAN	Milk has been delivered recently and the tubes inside the milk container must be cleaned.	Turn the froth adjustment dial to CLEAN.
INSERT WATER SPOUT	The hot water spout is not inserted or is inserted incorrectly.	Insert the water spout (C5) as far as it will go.
INSERT MILK CONTAINER	The milk container is not inserted correctly.	Insert the milk container (fig. 19) as far as it will go.
EMPTY CIRCUIT FILL CIRCUIT HOT WATER Confirm?	The water circuit is empty.	Press OK to deliver water from the spout (D5) until it flows out normally.

TROUBLESHOOTING

Below is a list of some of the possible malfunctions.

If the problem cannot be resolved as described, contact Customer Services.

PROBLEM	POSSIBLE CAUSE	SOLUTION
The coffee is not hot .	The cups were not preheated.	Warm the cups by rinsing them with hot water (Please note: you can use the hot water function).
	The infuser has cooled down because 2/3 minutes have elapsed since the last coffee was made.	Before making coffee, press the  button to rinse and heat the infuser.
	A low coffee temperature is set.	Set a high coffee temperature in the menu.
The coffee is weak or not creamy enough.	The coffee is ground too coarsely.	Turn the grinding adjustment dial one click anticlockwise towards "1" while the coffee mill is in operation (fig. 10). Continue one click at a time until coffee delivery is satisfactory. The effect is only visible after delivering 2 coffees (see the section: "Adjusting the coffee mill" on page 12).
	The coffee is unsuitable.	Use pre-ground coffee for espresso machines.

The coffee is delivered too slowly or a drop at a time.	The coffee is ground too finely.	Turn the grinding adjustment dial one click clockwise towards "7" while the coffee mill is in operation (fig. 10). Continue one click at a time until coffee delivery is satisfactory. The effect is only visible after delivering 2 coffees (see the section: "Adjusting the coffee mill" on page 12).
The milk does not come out of the milk spout.	The spouts are blocked.	Clean the spouts with a toothpick (fig. 27B).
Il latte non esce dal tubo erogazione	The milk container lid is dirty.	Clean the milk container lid as described in the section "Cleaning the milk container".
The milk contains large bubbles and squirts out of the milk spout or there is little froth.	The milk is not cold enough or is not semi-skimmed.	Use skimmed or semi-skimmed milk at refrigerator temperature (about 5° C). If the result is not as you wished, try changing brand of milk.
	The froth adjustment dial is incorrectly adjusted.	Adjust following the instructions in the section "Making cappuccinos and milk based coffees".
	The milk container lid or froth adjustment dial are dirty	Clean the milk container lid and dial as described in the section "Cleaning the milk container".
	The hot water/steam connection nozzle is dirty	Clean the connection nozzle as described in the section "Cleaning the hot water/steam nozzle".
The appliance does not come on.	It is not plugged into the mains socket.	Plug into the mains socket.
	The main switch (A8) is not turned on.	Place the main switch in the I position (fig. 1).
The infuser cannot be extracted	The appliance has not been turned off correctly	Turn the appliance off by pressing the  button (page 9).