



Instructions for use

ECAM31X.6Y - 31X.8Y

MAGNIFICA
— EVO NEXT —



Magnifica Evo Next Contents

DESCRIPTION OF THE MACHINE (A)	4
DESCRIPTION OF PANEL (B)	6
Following selection of drink (e.g. Espresso)	7
DESCRIPTION OF HOMEPAGE (C)	7
DESCRIPTION OF ACCESSORIES (D)*	8
DESCRIPTION OF MILK CARAFE (E)	9
USING THE MACHINE FOR THE FIRST TIME	10
Select your language	10
Fill the water tank	11
Prepare the machine	11
Using for the first time.....	11
Check the hardness of the water.....	12
Setting water hardness.....	12
Installing a filter	13
Tutorial	14
Support for operation	14
TURNING THE MACHINE ON	15
Switching off for extended periods.....	16
TURNING THE MACHINE OFF	16
Access the settings menu	17
MENU SETTINGS	17
Rinsing	17
Descaling.....	18
Water filter	18
Milk carafe.....	19
Drain water.....	19
Auto-off.....	20
Beep sound	20
Energy saving	21
Coffee temperature	21
Grinder	22
Water hardness.....	22
Languages.....	22
Statistics.....	23
Default values.....	23
Serial number.....	24
Support	24
SELECTION OF PROFILES	25
Set up the machine to make coffee-based drinks	26
Directly selected coffee-based drinks	26
Drinks from the “More” menu (B10).....	26

COFFEE-BASED DRINKS	26
Preparation with pre-ground coffee	27
Tips for a hotter coffee.....	28
DIRECTIONS FOR COFFEE-BASED DRINKS.....	28
MILK-BASED DRINKS	29
Preparing the milk carafe	29
What milk to use?	29
Filling and attaching the milk carafe	29
Making milk-based drinks	30
Cleaning the milk carafe after each use (Clean function)	30
Preparing several drinks in succession:	30
After multiple preparations, the milk container is empty or the milk that remains is not enough to make further drinks.....	30
After multiple preparations, there is enough milk left in the container to make further drinks	31
Following preparation of milk-based drinks — general notes:.....	31
HOT WATER	32
“MY” FUNCTION	33
CLEANING THE MACHINE	34
Internal circuit of the machine.....	35
Coffee grounds container.....	35
Drip tray and drip tray grille	36
Inside of the machine	37
Water tank.....	37
Coffee spouts.....	37
Removable brewing unit	37
Pre-ground coffee funnel	38
Control panel (B)	38
Thorough cleaning of milk carafe	38
DESCALING.....	40
FREQUENT AND ALARM MESSAGES	43
FAQ	49
TECHNICAL DATA.....	56
Tips for Energy Saving	56

Magnifica Evo Next Description of the machine (A)

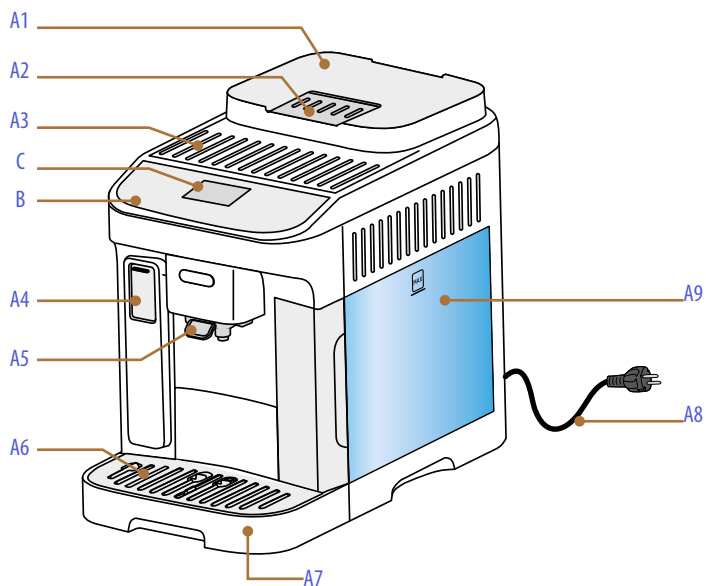

- A1.** Bean hopper with lid
- A2.** Pre-ground coffee funnel flap
- A3.** Cup shelf
- A4.** Accessories connector flap
- A5.** Coffee spouts (height-adjustable)
- A6.** Cup tray
- A7.** Drip tray
- A8.** Power cord
- A9.** Removable water tank

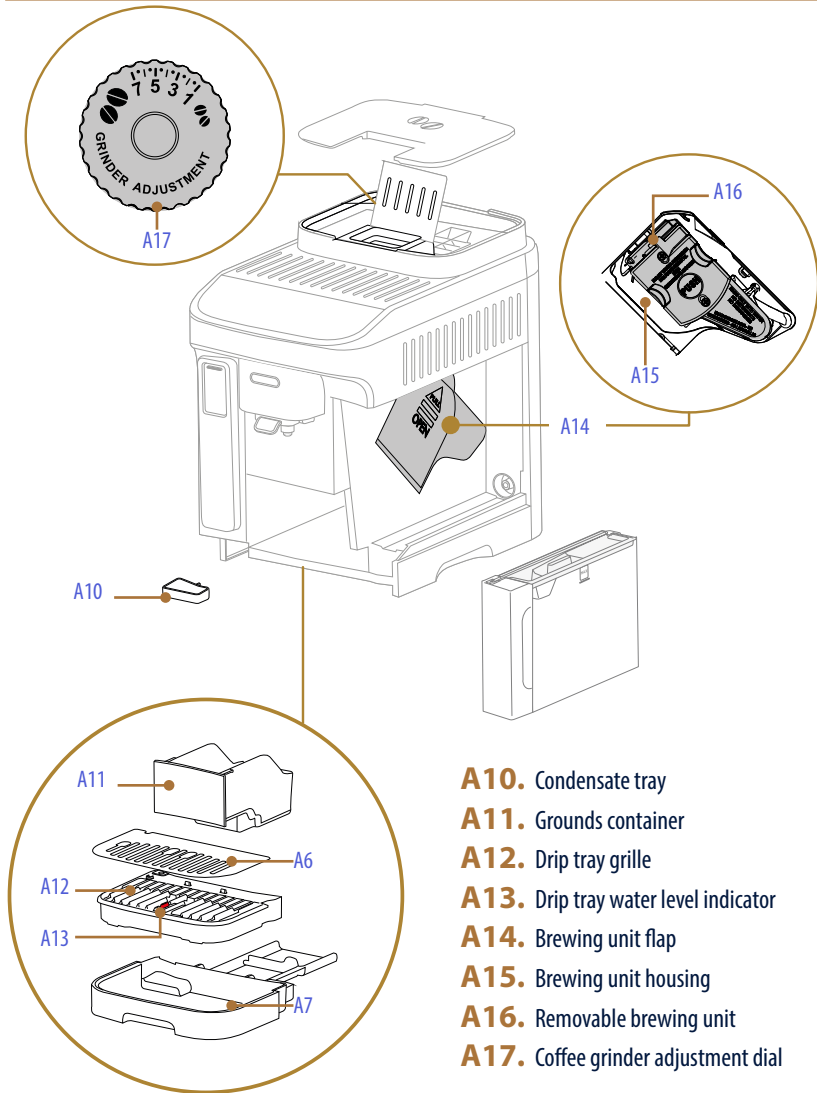

Magnifica Evo Next Description of panel (B)

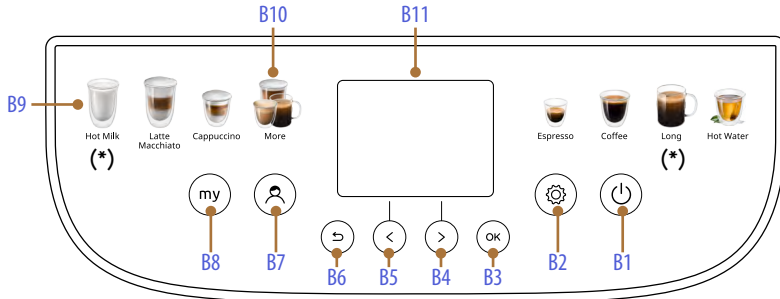

- B1.** ON/Standby button
- B2.** Machine settings menu button
- B3.** Press OK to confirm
- B4.** Scroll arrow/intensity selection - pre-ground
- B5.** Scroll arrow/quantity selection
- B6.** ↵ button (Esc) used to exit
- B7.** Profile change button
- B8.** "My" button: customization of drinks
- B9.** Direct drink selection
- B10.** Extra drinks menu (varies according to model)
- B11.** Display

Drink	ECAM31X.8Y	ECAM31X.6Y
Doppio+ 	✓	✓
2x Espresso 	✓	✓
Americano 	✓	✗
Long 	Directly selected drink	✓

Drink	ECAM31X.8Y	ECAM31X.6Y
Cappuccino Mix 	✓	✓
Cappuccino+ 	✓	✗
Espresso Macchiato 	✓	✗
Hot milk 	Directly selected drink (Hot Milk)	✓

Magnifica Evo Next Description of homepage (C)

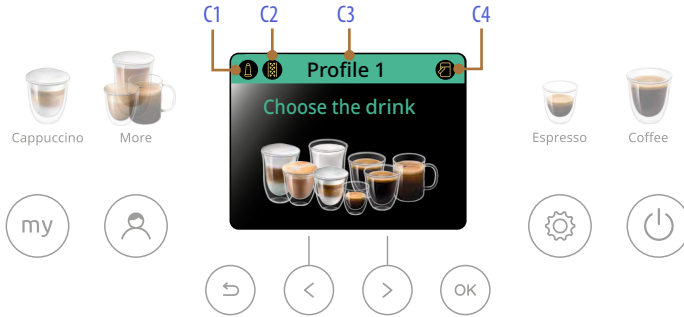

- C1.** Filter spent indicator
- C2.** Descaling required indicator
- C3.** Selected profile
- C4.** Milk carafe Clean alert indicator

Following selection of drink (e.g. Espresso)



- C5.** Name of selected drink
- C6.** Selected quantity (variable using "<" button B5)
- C7.** Selected intensity (variable using ">" button B4)

Magnifica Evo Next Description of accessories (D)*

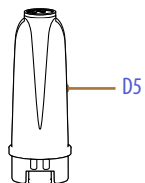
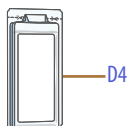
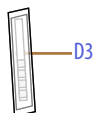
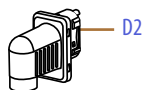

(* Accessories: number and type differ according to model)

- D1.** Pre-ground coffee measure
- D2.** Hot water spout
- D3.** "Water Hardness Test" strip
- D4.** Descaler
- D5.** Water softener filter

Magnifica Evo Next Description of milk carafe (E)

LatteCrema
HOT 

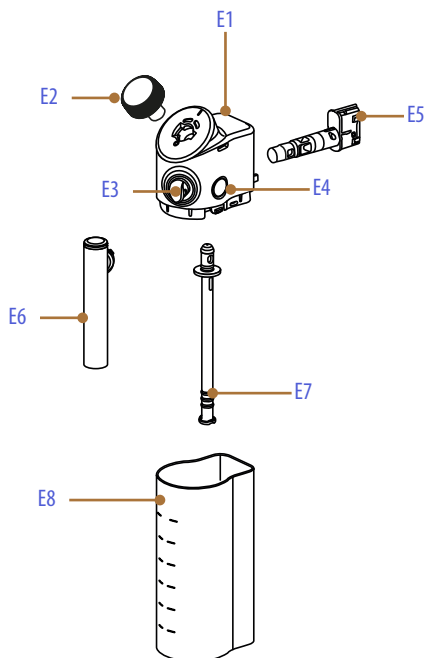

- E1.** Milk carafe lid
- E2.** Froth dial
- E3.** Milk spout connector (non removable)
- E4.** Lid release button
- E5.** Milk carafe connector
- E6.** Milk spout
- E7.** Milk intake tube (silicone)
- E8.** Milk container

Magnifica Evo Next Using the machine for the first time



Please note:



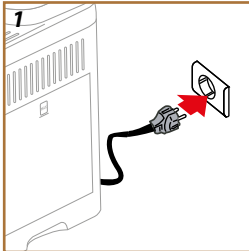

- Possible traces of coffee in the grinder are the result of settings tests performed on the machine before sale, proof of the meticulous care and attention we invest in our products.
- The first time the machine is used, all removable accessories and components designed to make contact with water and milk (water tank, water spout, milk carafe, etc.) should be rinsed with hot water. It is advisable to wash the milk carafe in the dishwasher (see section [Thorough cleaning of milk carafe](#)).



1. Connect the power cord (A8) to the mains supply (fig. 1).

The machine switches on and will show you how to set it up the way you prefer: follow the instructions displayed (B11) and the Magnifica will be ready for use!

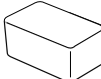
Here are the essentials:

	Cold drinking water
	Hot water spout <i>(already fitted to the machine)</i>
	Your favourite coffee beans
	A container <i>(make sure the capacity is at least 0.2 litres)</i>
	Water hardness test strip <i>(you'll find it in the accessories pack)</i>

Select your language

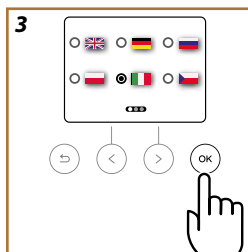
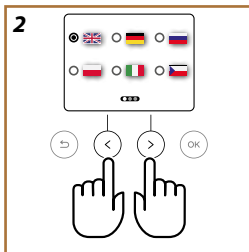

2. The display (B11) shows the language currently selected: use the scroll arrows ">" (B4) or "<" (B5) to select the flag corresponding to your language (fig. 2).
3. Press "OK" (B3) to confirm the language selected (fig. 3).

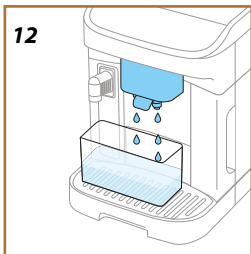
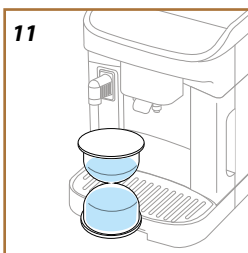
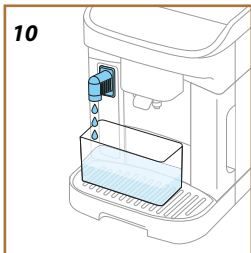
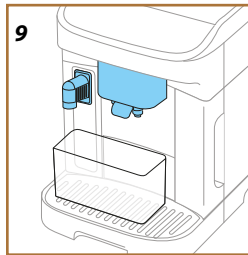
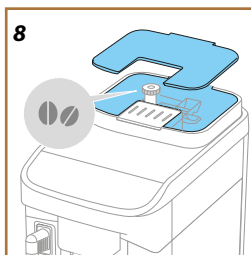
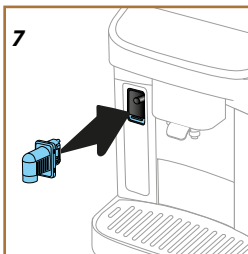
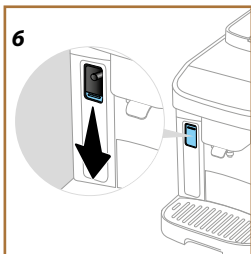
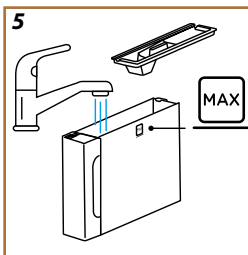
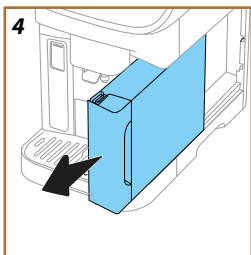

Fill the water tank

4. Remove the water tank (A9) (fig. 4).
5. Fill the tank with cold drinking water up to the MAX level (fig. 5) and reposition it in the machine, then press ">" (B4).

Prepare the machine

6. Check that the hot water spout (D2) is attached to the machine: if not, press downwards on the accessories connector flap (A4) (fig. 6) and fit the hot water spout (fig. 7). Press ">" (B4).
7. Fill the bean container (A1) (fig. 8), then confirm by pressing ">" (B4)

Using for the first time

8. Position a container of at least 0.2 litres capacity under the coffee spout (A5) and the hot water spout (D2) (fig. 9).
9. Press "OK" (B3) to start the rinse cycle (fig. 10). The rinse will stop automatically.
10. The machine now starts heating up (fig. 11), continuing until hot water is delivered from the coffee spout (A5) (fig. 12).
11. Press "OK" (B3) to move on to the next step.







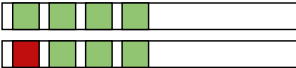

Check the hardness of the water

The machine will prompt for descaling to be carried out after a predetermined period of time, depending on the water hardness. The machine can also be programmed according to the actual hardness of the local water supply, so that descaling is required less frequently. Accordingly, it is advisable to set the correct value without delay, following the machine's step by step guide. Proceed as follows:

12. Take the "Total hardness test" strip (D3) (in the accessories pack) and remove it from its wrapper. Press ">" (B4).
13. Fill a glass with a sample of the water you intend to use in your machine, and immerse the strip fully for approximately one second. Press ">" (B4).
14. Remove the strip from the water and shake lightly. After about a minute, 1, 2, 3, or 4 red squares appear, depending on the hardness of the water. Each square corresponds to one level. Press ">" (B4).

Setting water hardness

15. Using the scroll arrows "<" (B5) or ">" (B4), select the dot that corresponds to the level of hardness detected using the test strip, as indicated in the following table:

Test strip	Water hardness
	
	
	
	

16. Press "OK" (B3).
17. The machine is now reprogrammed with the new water hardness setting. Press "OK" (B3).

Please note:

The water hardness can be changed at any time by way of the settings menu (B2) (see "Water hardness").

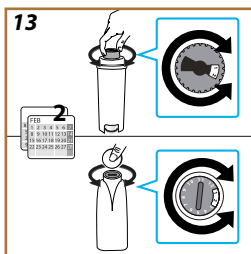

Installing a filter

To ensure the performance of the machine remains constant over time, a message will suggest you install a De'Longhi water softener filter (D5). Proceed as follows to install the filter straight away, or alternatively, press “←” (B6) to postpone installation:

18. Take the filter out of the pack and press “OK” (B3).
19. Turn the date indicator to show the next 2 months (fig. 13): press the forward arrow “>” (B4) to pass on to the next step.

Please note:

The filter lasts about two months assuming normal use of the machine; if on the other hand the machine remains idle with the filter installed, it will not last more than three weeks, at most.

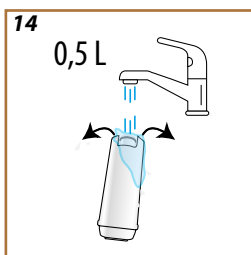

20. To activate the filter, run tap water through the hole in the centre of the filter until water comes out of the openings at the side for more than a minute (fig. 14). Press the forward arrow “>” (B4) to pass on to the next step.

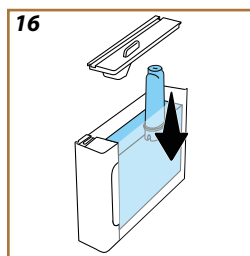
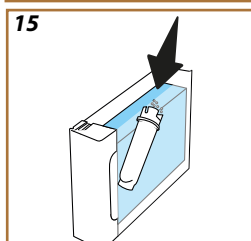

21. Remove the water tank (A9) from the machine and fill with cold drinking water; remove the lid of the tank and immerse the filter in the water, while squeezing the middle section 2 or 3 times so that the air bubbles can escape (fig. 15). Press the forward arrow “>” (B4) to pass on to the next step.

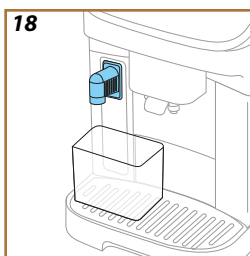
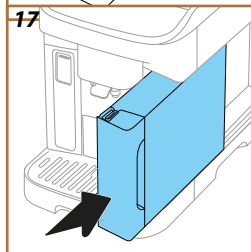

22. Locate the filter in the special housing (fig. 16) and push fully home. Close the water tank with the lid. Press the forward arrow “>” (B4) to pass on to the next step.

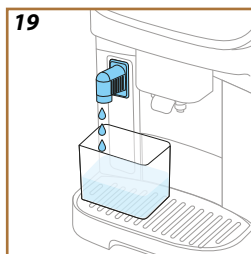

23. Return the water tank to the machine (A9) (fig. 17). Press the forward arrow “>” (B4)

24. Position an empty container of at least 0.5 litres capacity under the hot water spout (fig. 18) and press “OK” (B3) to activate the filter.

25. The machine delivers hot water (fig. 19) and stops automatically.

26. The filter is now operational. Press “OK” (B3).

The technical part is finished: press the forward arrow “>” (B4).

Tutorial

A short video tutorial will help you get to know your machine better.

Support for operation

Scanning the QR code shown in the display with your smartphone, you can get access to manuals and informative materials for operation of the machine. Press the forward arrow ">" (B4) .

The QR code can be found in the settings menu (B2), under the item "Support".

Press the forward arrow ">" (B4), then "OK" (B3): the machine is ready for use.

Please note:

- The first time the machine is used, it will be necessary to make 4-5 cappuccinos before the drink in the cup tastes as it should.
- The first time the machine is used, the water circuit will be empty and operation could be very noisy. The noise becomes less as the circuit fills.

Magnifica Evo Next Turning the machine on



Please note:

Each time the machine is turned on, it carries out an automatic preheat and rinse cycle, which cannot be interrupted. The machine is not ready for use until the cycle has been completed.

1. To turn the machine on, press the  button (B1) and hold for 0.5 second (fig. 20): the machine switches on.
2. Once preheated to a preset temperature, a rinse cycle takes place and hot water flows from the coffee spouts (A5); in addition to heating the boiler, this has the effect of heating the internal circuits by circulating hot water through them.

Magnifica Evo Next Turning the machine off

Whenever the machine is turned off after being used to make coffee, it will run a rinse cycle automatically.

1. To turn the machine off, press the  button (B1) and hold for 0.5 second (fig. 20).
2. If envisaged, the machine runs a rinse cycle, delivering hot water from the coffee spout (A5), then switches off (stand-by).

Important!

Never unplug the machine while it is switched on.

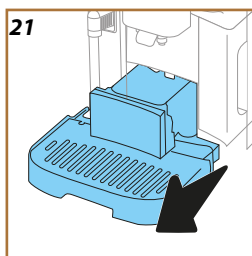

Switching off for extended periods

If the machine is not going to be used for extended periods (e.g. holidays, periods of absence), follow the directions in heading [Drain water](#).

If the machine is not used for a few days, proceed as follows:

1. To turn the machine off, press the  button (B1) and hold for 0.5 second (fig. 20).
2. Remove, empty and clean the drip tray (A7), the grounds container (A11) (fig. 21) and the water tank (A9);
3. Unplug the power cord (A8) from the socket.

Please note:

When turning the machine on again, fill the water tank and, before making any kind of drink, run 3 rinse cycles as indicated in section [Rinsing](#).



Magnifica Evo Next Menu settings

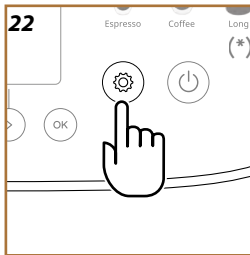

Access the settings menu

1. Press the button (B2) (fig. 22).

The settings are divided into three topics:

- **Maintenance**
 - __Rinsing
 - __Descaling
 - __Water filter
 - __Milk carafe
 - __Drain water
- **Preferences**
 - __Auto-off
 - __Beep sound
 - __Energy saving
 - __Coffee temperature
 - __Grinder
 - __Water hardness
 - __Languages
 - __Default values
- **Info**
 - __Statistics
 - __Serial number
 - __Support

2. Use the scroll arrows ">" (B4) or "<" (B5) to select the topic of interest.
3. Press "OK" (B3) to access the settings.
4. Press "" (B6) to go back.
5. Press "" again to go back to the homepage.

Maintenance: Rinsing

1. Press the button (B2).
2. Use the scroll arrows ">" (B4) or "<" (B5) to select "Maintenance". Press "OK" (B3).
3. Use the scroll arrows ">" (B4) or "<" (B5) to select "Rinsing" (fig. 23). Using this function, hot water can be delivered from the coffee spout to clean and heat the internal circuit of the machine. To carry out a rinse immediately:
 4. Place a container of at least 0.2 litres capacity under the coffee spout (A5) (fig. 9).
 5. Press "OK" (B3): after a few seconds, hot water is delivered from the coffee spout to clean and heat the internal circuit of the machine.
 6. To stop rinsing, press "" (B6) or wait for rinsing to stop automatically.

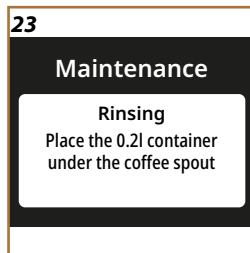

Please note:

- If the machine is not used for more than 3-4 days, it is highly advisable, when turning it on again, to run 2-3 rinses before use;
- After cleaning, it is normal for the grounds container (A11) to contain water.

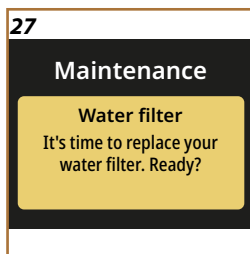
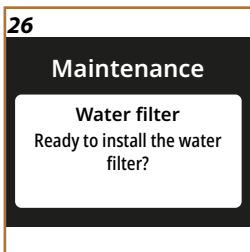
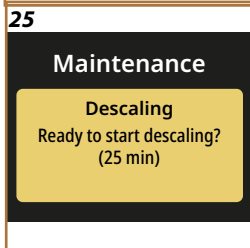
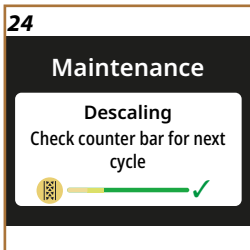

Maintenance: Descaling

1. Press the button (B2).
2. Use the scroll arrows ">" (B4) or "<" (B5) to select "Maintenance". Press "OK" (B3).
3. Use the scroll arrows ">" (B4) or "<" (B5) to select "Descaling".

The display (B11) shows a progress bar (fig. 24) indicating when the next descale will be required (fig. 25).

4. To descale immediately, press "OK" (B3) and follow the guided procedure. The instructions are also given in the heading "Descaling".
5. To select a different item, press the scroll arrow ">" (B4) or "<" (B5) until the required topic is highlighted; otherwise press "↶" (B6) to exit.

Maintenance: Water filter

To ensure the performance of the machine remains constant over time, it is advisable to install a De'Longhi water softener filter (D5).

For further information, visit www.delonghi.com.

WATERFILTER EAN: 8004399327252

1. Press the button (B2).
2. Use the scroll arrows ">" (B4) or "<" (B5) to select "Maintenance". Press "OK" (B3).
3. Use the scroll arrows ">" (B4) or "<" (B5) to select "Water filter".

If the water filter is not installed (fig. 26):

4. Press "OK" (B3) and follow the guided procedure. The instructions are also given in the heading "Installing a filter".

If the water filter needs to be replaced (fig. 27) press "OK" (B3):

4. Press "OK" (B3) to confirm and follow the guided procedure.
5. Detach the water tank (A9), remove the lid and take out the water softener filter (fig. 28). Press "OK" (B3) to confirm removal of the filter and proceed. Press the scroll arrow ">" (B4) to continue.

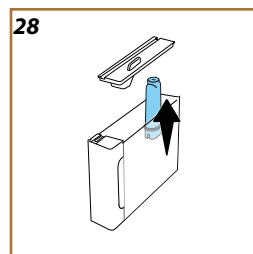

6. To install a new filter: press "OK" (B3) and follow the guided procedure. The instructions are also given in the heading "Installing a filter".
7. To use the machine without a filter: press "↶" (B6). To select a different item, press the scroll arrow ">" (B4) or

29

Maintenance

Milk carafe

How to get the best results from your milk carafe

"<" (B5) until the required topic is highlighted; otherwise press "↩" (B6) to exit.

8. Press "↩" a second time to go back to the homepage.

Maintenance: Milk carafe

1. Press the  button (B2).
2. Use the scroll arrows ">" (B4) or "<" (B5) to select "Maintenance". Press "OK" (B3).
3. Use the scroll arrows ">" (B4) or "<" (B5) to select "Milk carafe" (fig. 29).

This section has all the information you need to guarantee the long-term reliability of your milk carafe, and ensure you get your froth just right every time. Press "OK" (B3). Use the scroll arrows ">" (B4) or "<" (B5) to select the topic of interest:

- **Cleaning:** To start the cleaning cycle, press "OK" (B3) and follow the guided procedure. On completion of the cycle, press "OK" (B3) to go back to the homepage.
- **Deep cleaning:** the machine will prompt regularly for deep cleaning. To view the operations that must be carried out, press "OK" (B3) and view the various screens with the aid of the scroll arrows ">" (B4) or "<" (B5). The instructions are also given in the heading "Thorough cleaning of milk carafe". When done, press "OK" (B3) to go back to the homepage.
- **Tips on frothing:** press "OK" (B3) and view the various screens with the aid of the scroll arrows ">" (B4) or "<" (B5). This information is also available in the heading "What milk to use?". When done, press "OK" (B3) to go back to the homepage.

Maintenance: Drain water

1. Press the  button (B2).
2. Use the scroll arrows ">" (B4) or "<" (B5) to select "Maintenance". Press "OK" (B3).
3. Use the scroll arrows ">" (B4) or "<" (B5) to select "Drain water" (fig. 30).

To avoid the water in the circuit freezing if the machine is to be left idle for an extended period, or before taking it to a service centre, it is advisable to drain the water circuit.

4. Press "OK" (B3) and follow the guided procedure.
5. Remove the drip tray (A7) (fig. 21); empty and clean both the tray and the grounds container (A11). Return the parts to the machine.
6. Press the forward arrow ">" (B4). Position a container of at least 0.2 litres capacity under the coffee spout (A5) and the hot water spout (D2) (fig. 9).

30

Maintenance

Drain water

Ready to start draining the water circuit?

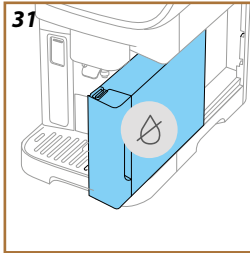

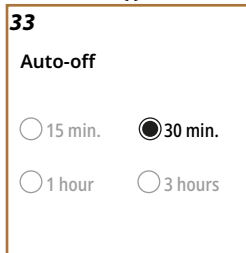
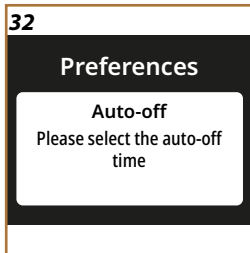

7. Press "OK" (B3): the machine will run a rinse cycle, releasing hot water from the spouts.
8. Once rinsing is complete, remove the water tank (fig. 31) and empty it.
9. Remove the filter (D5) (if installed) from the water tank and press the forward arrow ">" (B4).
10. Reposition the tank (empty) and press the forward arrow ">" (B4).
11. When ready, confirm by pressing "OK" (B3).
12. Wait for the machine to empty the circuit; (Caution: beware of hot water coming from the spouts!). As the water circuit gradually empties, the machine could become noisier: this is a normal aspect of operation.
13. Once the circuit has emptied, remove, empty and reposition the drip tray, then press "OK" (B3).
14. Press "OK" (B3): the machine will switch off (standby).
15. Unplug the machine from the mains power supply.
16. The next time the machine is turned on, follow the instructions in the heading "Using the machine for the first time".

Preferences: Auto-off



1. Press the  button (B2).
2. Use the scroll arrows ">" (B4) or "<" (B5) to select "Preferences". Press "OK" (B3).
3. Use the scroll arrows ">" (B4) or "<" (B5) to select "Auto-off" (fig. 32).

Auto-off can be set so that if the machine is not being used, it will switch off after 15 or 30 minutes or after 1 or 3 hours have elapsed.

4. Press "OK" (B3): the display will show the auto-off time currently selected and the other options available (fig. 33).
5. Use the scroll arrows ">" (B4) or "<" (B5) to select a preferred auto-off time other than the current setting; press "OK" (B3) to save the new setting.
6. Press "" (B6) to go back to the previous screen.
7. Press "" (B6) to go back to the homepage.

Preferences: Beep sound

1. Press the  button (B2).
2. Use the scroll arrows ">" (B4) or "<" (B5) to select "Preferences". Press "OK" (B3).

34

Preferences

Beep
Enable or disable beep sounds

- Use the scroll arrows ">" (B4) or "<" (B5) to select "Beep" (fig. 34). If enabled, the machine emits a beep whenever an operation is performed. Selecting this item, you can enable or disable the beep.
- Press "OK" (B3): the display will show the preference currently selected.
- Use the scroll arrows ">" (B4) or "<" (B5) to enable (On) or disable (Off) the function: press "OK" (B3) to save the new setting.
- Press "↶" (B6) to go back to the previous screen.
- Press "↶" (B6) to go back to the homepage.

35

Preferences

Energy saving
Use to save energy





Preferences: Energy saving

- Press the  button (B2).
- Use the scroll arrows ">" (B4) or "<" (B5) to select "Preferences". Press "OK" (B3).
- Use the scroll arrows ">" (B4) or "<" (B5) to select "Energy saving" (fig. 35).

When activated, the function reduces energy consumption in compliance with European regulations. Selecting this item, you can enable or disable energy saving.

- Press "OK" (B3): the display will show the preference currently selected.
- Use the scroll arrows ">" (B4) or "<" (B5) to enable (On) or disable (Off) the function: press "OK" (B3) to save the new setting.

Please note:

- The  symbol indicates that the function is active.
- The  symbol indicates that the function is not active.

36

Preferences

Coffee temperature
Please set the water temperature for coffee

Preferences: Coffee temperature

- Press the  button (B2).
- Use the scroll arrows ">" (B4) or "<" (B5) to select "Preferences". Press "OK" (B3).
- Use the scroll arrows ">" (B4) or "<" (B5) to select "Coffee temperature" (fig. 36).

Selecting this item, you can change the temperature of the water used to make coffee.

- Press "OK" (B3): the display will show the preference currently selected.
- Use the scroll arrows ">" (B4) or "<" (B5) to select the preferred temperature: press "OK" (B3) to save the new setting.
- Press "↶" (B6) to go back to the previous screen.
- Press "↶" (B6) to go back to the homepage.

37

Preferences

Grinder

Adjust your grind level for a perfect extraction

Please note:

The effect of varying the temperature is most noticeable with long drinks.

Preferences: Grinder

1. Press  to access the settings menu (fig. 13).
2. Use the scroll arrows ">" (B4) or "<" (B5) to select "Preferences". Press "OK" (B3).
3. Use the scroll arrows ">" (B4) or "<" (B5) to select "Grinder" (fig. 37). The machine offers a tutorial on how to adjust the coffee grinder correctly and ensure the best results.
4. Press "OK" (B3): view the tips on how grinding is adjusted, and scroll the pages with the arrows ">" (B4) or "<" (B5) to read the entire tutorial.
5. Press "OK" (B3) to go back to the homepage.

Please note:

- After completing the above procedure, at least 3 coffees should be prepared and delivered before making any further adjustment to the coffee grinder. If coffee delivery is still not correct, repeat the procedure.
- The adjuster ring must be turned only when the coffee mill is in operation during the initial step of coffee preparation.

38

Preferences



Water hardness

You can set the water hardness level using the test strip

Preferences: Water hardness

1. Press the  button (B2).
2. Use the scroll arrows ">" (B4) or "<" (B5) to select "Preferences". Press "OK" (B3).
3. Use the scroll arrows ">" (B4) or "<" (B5) to select "Water hardness" (fig. 38).

To enter a new water hardness setting, proceed as follows:

4. Measure the water hardness as described above, see "[Check the hardness of the water](#)".
5. Press "OK" (B3) and change the selection using the scroll arrows ">" (B4) or "<" (B5).
6. Press "OK" (B3) to store the new setting.
7. Press  (B6) to go back to the previous screen.
8. Press  (B6) to go back to the homepage.

Preferences: Languages

1. Press the  button (B2).
2. Use the scroll arrows ">" (B4) or "<" (B5) to select "Preferences". Press "OK" (B3).

39

Preferences

Languages

What language should we speak in?

40

Preferences

Default values

Reset the machine to default values entirely or for the single profile

41

Info

Statistics

Check the activities of your coffee machine

3. Use the scroll arrows ">" (B4) or "<" (B5) to select "Languages" (fig. 39).

To enter a new language setting, proceed as follows:

4. Press "OK" (B3) and change the selection using the scroll arrows ">" (B4) or "<" (B5).
5. Press "OK" (B3) to store the new setting.
6. Press "↶" (B6) to go back to the previous screen.
7. Press "↶" (B6) to go back to the homepage.

Preferences: Default values

1. Press the  button (B2).
2. Use the scroll arrows ">" (B4) or "<" (B5) to select "Preferences". Press "OK" (B3).
3. Use the scroll arrows ">" (B4) or "<" (B5) to select "Default values" (fig. 40).

This function resets all menu settings and all user customizations, restoring the factory default values (with the exception of the language, which remains as set, and the statistics).

4. Press "OK" (B3): use the scroll arrows ">" (B4) or "<" (B5) to select what you want to reset: "Machine" or "Single profile".
- **Machine:** Press "OK" (B3) twice and wait for the machine to reset itself. Press "OK" (B3) again to go back to the homepage.

Please note:

When the machine has been reset to default values, it displays the tutorial prompt.

- **Single profile:** Press "OK" (B3) and use the scroll arrows ">" (B4) or "<" (B5) to select the profile you want to reset. Press "OK" (B3) twice and wait for the machine to reset the profile. Press "OK" (B3) again to go back to the homepage.

Info: Statistics

1. Press the  button (B2).
2. Use the scroll arrows ">" (B4) or "<" (B5) to select "Info". Press "OK" (B3).
3. Use the scroll arrows ">" (B4) or "<" (B5) to select "Statistics" (fig. 41).
4. Press "OK" (B3). View all the data of your machine, scrolling with the arrows ">" (B4) or "<" (B5).
5. Press "↶" (B6) to go back to the previous screens.
6. Press "↶" (B6) twice to go back to the homepage.



42

Info

Serial number:

XXXXXXXXXXXXXXXXXXXX

Info: Serial number

1. Press the  button (B2).
2. Use the scroll arrows ">" (B4) or "<" (B5) to select "Info". Press "OK" (B3).
3. Use the scroll arrows ">" (B4) or "<" (B5) to select "Serial number" (fig. 42). The display will show the serial number of the machine, which is useful for identification purposes.
4. Press "" (B6) to go back to the previous screens.
5. Press "" (B6) to go back to the homepage.



43

Info

Support



Scan the QR code to access manual and get support

Info: Support

1. Press the  button (B2).
2. Use the scroll arrows ">" (B4) or "<" (B5) to select "Info". Press "OK" (B3).
3. Use the scroll arrows ">" (B4) or "<" (B5) to select "Support" (fig. 43).
4. Press "OK" (B3). Scan the QR-Code with your smartphone to see the manual and access support.
5. Press "" (B6) to go back to the previous screen.
6. Press "" (B6) twice to go back to the homepage.

Magnifica Evo Next Selection of profiles

The machine has 3 selectable profiles, each one of which identified by a different colour:

- Profile 1: 
- Profile 2: 
- Profile 3: 

The default setting is Profile1: to select a different profile, press the  button (B7): the profile can be selected both before and after making the selection of the drink.



Magnifica Evo Next Coffee-based drinks

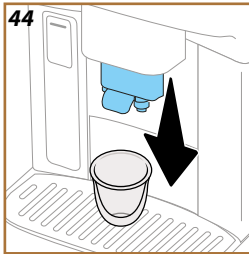

Set up the machine to make coffee-based drinks

Important!

Do not use green, caramelized or candied coffee beans as they could stick to the coffee grinder and render it unusable.

1. Place 1 or 2 cups under the coffee spout (A5).
2. Lower the spout as near as possible to the cup (fig. 44): this makes a creamier coffee.

The machine offers a wide variety of coffee-based drinks to select from. See [Extra drinks menu](#) (varies according to model) for details of the drinks included in "More" (B10).

Directly selected coffee-based drinks

1. Press the image corresponding to the drink (e.g. Espresso) (fig. 45).
2. Press "OK" (B3) if you want to use the standard quantity and intensity when delivering the drink, or to customize it, as follows:
 - Press the back arrow "<" (B5) to change the quantity (fig. 46): **S, M, L or XL**.
 - Press the forward arrow ">" (B4) to change the intensity (fig. 47): from **1** (extra-weak) to **5** (extra-strong).
3. Press "OK" (B3) to start the preparation: the machine proceeds to make the drink, and a description of each single step (grinding, delivery of coffee) appears on the display.
4. Once the drink has been delivered, changes can be saved and stored in the current profile, pressing "OK" (B3). If you do not want to save any new settings, press "↶" (B6).

Please note

If saved, the new settings will be stored **ONLY** in the selected profile.

The machine is ready to be used again.

Drinks from the "More" menu (B10)

1. Press the "More" image (fig. 48).
2. Use the scroll arrows ">" (B4) or "<" (B5) to select the desired drink. Press "OK" (B3).
3. Press "OK" (B3) to confirm the selection of the drink.
4. The drink can now be customized:
 - Press the back arrow "<" (B5) to change the quantity (fig. 46): **S, M, L or XL**.
 - Press the forward arrow ">" (B4) to change the intensity (fig. 47): from **1** (extra-weak) to **5** (extra-strong).
5. Press "OK" (B3) to start the preparation: the machine proceeds to make the drink, and a description of each single step (grinding, de-

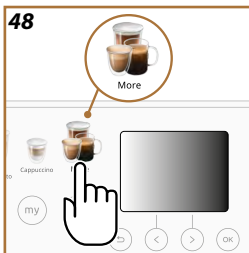
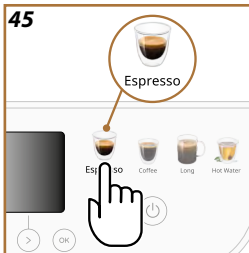

- livery of coffee) appears on the display.
- Once the drink has been delivered, changes can be saved and stored in the current profile, pressing "OK" (B3). If you do not want to save any new settings, press "↶" (B6).

Please note

If saved, the new settings will be stored ONLY in the selected profile.

Preparation with pre-ground coffee

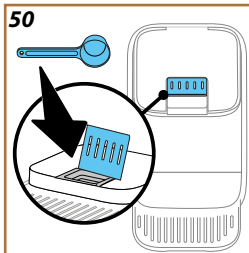

Important!

- Never add pre-ground coffee when the machine is off, or it could spread through and soil the inside of the machine. In this situation the machine could be damaged.
- Never use more than 1 level scoop (D1) of pre-ground coffee, otherwise the inside of machine could become soiled, or the funnel blocked.
- When using pre-ground coffee, you can make only one cup at a time.
- Certain drinks cannot be prepared using pre-ground coffee **Doppio+**, **2x Espresso**, **Cappuccino+**.
- When making **Long coffee**: halfway through preparation, when prompted by the machine, add one level scoop of pre-ground coffee and press "OK" (B3).





1. Select the drink to be prepared, as illustrated in headings "Directly selected coffee-based drinks" or "Drinks from the "More" menu (B10)"
2. Having accessed the drink customization screen, scroll with the forward arrow ">" (B4) to the ☞ symbol (coffee scoop) (fig. 49).
3. Lift the flap of the pre-ground coffee funnel (A2) (fig. 50).
4. Check that the pre-ground coffee funnel is not blocked; add one level scoop of pre-ground coffee and press "OK" (B3) to proceed with delivery.
5. The machine proceeds with preparation and a description of each single step (water heating, delivery of coffee) appears on the display. Once the preparation has been completed, the machine is ready for use again.

Magnifica Evo Next Directions for coffee-based drinks

- While the machine is making coffee, delivery can be interrupted at any time by pressing the button corresponding to “Stop” (B5). or “” (B6).
- At the end of delivery, to increase the quantity of coffee in the cup, simply press the button corresponding to “Extra” (B4). When the desired quantity has been reached, press the button corresponding to “Stop” (B5) or “” (B6).
- Sundry alarm messages could be displayed while using the machine (“Fill tank with fresh water up to the MAX level”, etc.) their meaning is explained in heading “Frequent and alarm messages”.
- If the coffee emerges drop-by-drop, too weak and not creamy enough or too cold, refer to the tutorial on adjusting the coffee grinder (see section “Grinder”) and heading “FAQ”.
- If “Energy saving” mode is activated, there may be a few seconds delay before the first coffee is delivered.

Tips for a hotter coffee

To make a hotter coffee, proceed as follows:

- run a rinse cycle before preparing and delivering the coffee (see “Rinsing” in the settings menu  (B2)).
- warm the cups with hot water using the hot water function (see heading “Hot water”).
- select a higher temperature setting for the coffee (see “Coffee temperature” in the settings menu  (B2)).

Magnifica Evo Next Milk-based drinks



Preparing the milk carafe

Please note





To avoid the preparation of milk with insufficient froth or large bubbles, always clean the milk carafes as described in sections "Cleaning the milk carafe after each use (Clean function)" and "Thorough cleaning of milk carafe"

What milk to use?

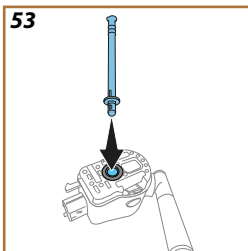
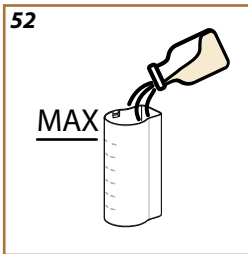
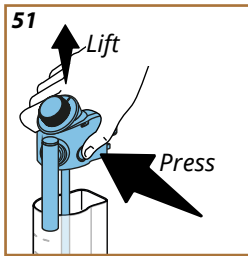
The quality of the froth can vary depending on:

- the temperature of the milk or vegetable drink used (for best results, always use milk or vegetable drinks straight from the fridge, 5 °C);
- type of milk or vegetable drink;
- the brand used;
- ingredients and nutritional values.



LatteCrema HOT	
 Cow's milk	
Whole (fat >3,5%)	✓
Semi-skimmed (fat between 1.5 and 1.8%)	
Skimmed (fat <0.5%)	
Vegetable drinks	
 Soya	✓
 Almond	✓
 Oatmeal	✓

Filling and attaching the milk carafe

1. Press the release button (E4) and lift the lid (fig. 51).
2. Fill the milk container (E8) with a sufficient quantity of milk, not exceeding the MAX level marked on the container (fig. 52);
3. Make sure the milk intake tube (E7) is secured correctly to the socket on the underside of the milk carafe lid (fig. 53);

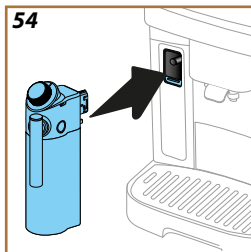

4. Reposition the lid on the milk container;
5. Lower the flap of the carafe connector (A4) and attach the carafe, pushing it fully home (fig. 54). The machine emits a beep (if the beep function is enabled);
6. Place a sufficiently large cup under the coffee spouts (A5) and under the milk spout (E6).
7. Make sure the dial (E2) is in the  position (Froth).

Making milk-based drinks

Select the desired drink directly from the control panel (B9) or from "More" (B10).

As with coffee-based drinks, a milk-based drink can be customized by selecting from the options available on the machine.

On the homepage, press directly on the image corresponding to the required drink.

To suspend delivery of the drink manually: press the back arrow "<" (B5) corresponding to "Stop" and pass on to the next ingredient, or press "↻" (B6) to stop the entire preparation.

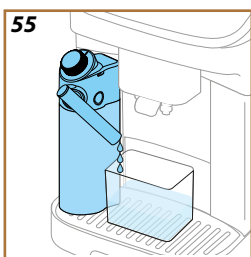

Cleaning the milk carafe after each use (Clean function)

Every time a milk drink is delivered, the machine will ask for the lid of the milk carafe to be cleaned (E1). To start the cleaning operation, proceed as follows:

1. Leave the milk carafe in the machine (there is no need to empty the container);
2. Position a cup or other recipient under the milk spout (E6) (fig. 55);
3. Press "OK" (B3) to start cleaning: hot water and steam will come out of the milk spout. Cleaning stops automatically.

Preparing several drinks in succession:

- Every time a milk-based drink has been prepared, the machine asks for the carafe to be cleaned (Clean function): other drinks can be delivered by selecting them directly or pressing "↻" (B6) to postpone cleaning. Proceed with cleaning of the carafe after the final preparation.

After multiple preparations, the milk container is empty or the milk that remains is not enough to make further drinks

- Having carried out the cleaning step ("Clean" function), disassemble the milk carafe and clean all components, proceeding as described in section "Thorough cleaning of milk carafe"

After multiple preparations, there is enough milk left in the container to make further drinks

- Having carried out the cleaning step ("Clean" function), remove the milk carafe and put it straight in the refrigerator. The carafe containing milk can be kept in the refrigerator no more than 2 days, after which time all components should be cleaned as described in the section "[Thorough cleaning of milk carafe](#)".

Important:

If the milk carafe is left out of the refrigerator for more than 30 minutes, disassemble and clean all components, proceeding as described in the section "[Thorough cleaning of milk carafe](#)".

Following preparation of milk-based drinks — general notes:

- If the milk carafe is not cleaned, the  symbol appears on the homepage (C4) as a reminder that cleaning is required. To start the function, see "[Milk carafe](#)".
- In certain cases, the machine will need to heat up before cleaning can take place.
- Wait until the Clean function has finished, to ensure it is completed correctly. The function is automatic. It must not be stopped while in progress.

Magnifica Evo Next Hot water

1. Push down the flap of the accessories compartment (A4) and attach the hot water spout (D2) (fig. 7).
2. Place a cup under the hot water spout.
3. On the control panel (B), press the image that indicates hot water.
4. Press the back arrow “<” (B5) to select the quantity (fig. 46): S, M, L or XL.
5. Press “OK” (B3) to start preparation.
6. Delivery will stop automatically.

Please note

- To suspend delivery manually, press the button corresponding to “Stop” (B5) or “↶” (B6).
- Immediately after delivery has stopped automatically, the quantity can be increased by pressing the button corresponding to “Extra” (B4).

Magnifica Evo Next “My” function

With the “my” function, you can select the quantity of each single ingredient used for preparation of the hot drink you want to make.

1. Check that the selected profile (C3) is the one for which you want to customize the drink.
2. You can access the function by pressing the dedicated “my” button (B8) and then using the forward arrow “>” (B4); now select the drink to be customized (by direct selection (B9) or via the “More” menu (B10)). Alternatively, the function can be accessed by selecting the desired drink (directly or via the “More” menu), then pressing the “my” button.
3. In the case of coffee-based drinks, select the intensity with the forward arrow “>” (B4).
4. Press “OK” (B3).
5. Make sure that a cup of the right size is placed under the coffee spout (A5) and press “OK” (B3).
6. As the drink is delivered, a progress bar will fill up gradually. Once the minimum programmable quantity is reached, the “OK” button (B3) will blink.
7. When the quantity in the cup is as desired, press “OK” (B3).
8. Press “OK” (B3) to store the new parameters for the drink under the selected profile.

Please note

- If saved, the new settings will be stored ONLY in the selected profile (C3).
- Customizing a single drink, the respective double version of the drink is automatically customized as well (e.g. Espresso).
- Programming mode can be exited at any given moment by pressing “↶” (B6): any values entered will not be saved.
- If the drink has already been programmed, the machine will overwrite the existing programming with the new.

Quantities table		
Drink*	Standard quantity	Programmable quantity
Espresso	40ml	20-180 ml
2X Espresso	40 ml + 40 ml	20-180 ml + 20-180 ml
Coffee	180ml	100-270 ml
Long	160ml	115-250 ml
Americano	150ml	70-480 ml
Doppio+	120ml	80-180 ml
Hot water	250ml	20-420 ml

(*) Numbers and types of drinks differ according to model.



Magnifica Evo Next Cleaning the machine

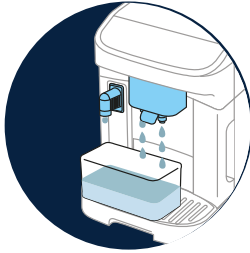

➔ INTERNAL CIRCUIT OF THE MACHINE

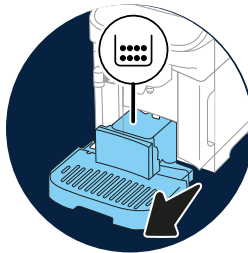

➔ COFFEE GROUNDS CONTAINER

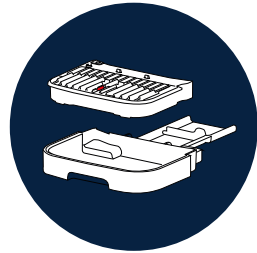

➔ DRIP TRAY AND DRIP TRAY GRILLE

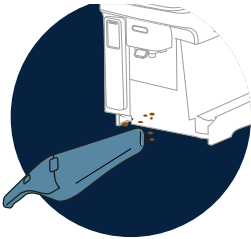

➔ INSIDE OF THE MACHINE

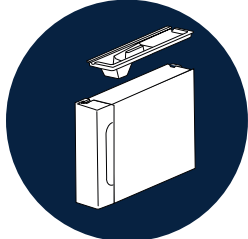

➔ WATER TANK



➔ COFFEE SPOUTS



➔ "REMOVABLE BREWING UNIT"



➔ PRE-GROUND COFFEE FUNNEL



➔ CONTROL PANEL (B)

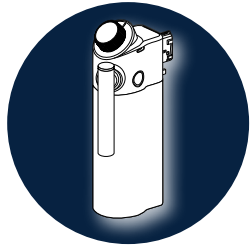

"THOROUGH CLEANING OF MILK CARAFE"

Please note

- Do not use solvents, abrasive detergents or alcohol to clean the machine. With De'Longhi superautomatic coffee machines, no chemical additives are required for cleaning purposes.
- Do not use metal objects to remove encrustations or coffee deposits as they could scratch metal or plastic surfaces.

Which items are dishwasher-safe

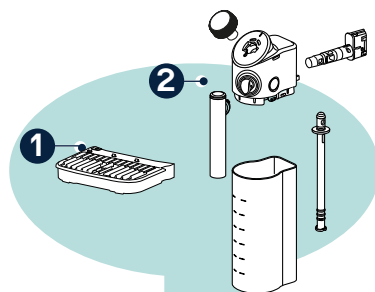

1 Drip tray grille (A12)

2 Hot Lattecrema Carafe
(all components must be
disassembled)

Internal circuit of the machine

If the machine has not been used for more than 3-4 days, it is strongly recommend that before any further use, it should be switched on ([Turning the machine on](#)) and rinsed 2 or 3 times, selecting the relative function "Rinsing".

Please note

Water may find its way into the grounds container during the above cleaning procedure: this is quite normal. (A11)

Coffee grounds container

When required by the machine, this must be emptied and cleaned. The machine cannot be used to make coffee again until the grounds container (A11) has been cleaned. The machine will display the message indicating the need to empty the grounds container 72 hours after the first coffee has been prepared, even if the container is not full (for the 72 hours to be calculated correctly, the machine must never be disconnected from the mains power supply).

Important! Danger of scalding

If several milk-based drinks are prepared one after the other, the metal cup grille (A6) becomes hot. Wait for it to cool down before touching it, and handle from the front only.

To clean (with the machine on):

1. Remove the drip tray (A7) and the coffee grounds container (A11);
2. Empty the drip tray and the grounds container and clean them, taking care to remove all residues that may have collected on the bottom.
3. Reposition the drip tray in the machine, complete with grille (A12) and grounds container.

Important!

When removing the drip tray, the coffee grounds container must always be emptied, even if it has not filled up noticeably. If this is not done, it can happen that when further coffees are prepared, the grounds container will fill up more than expected and clog the machine.

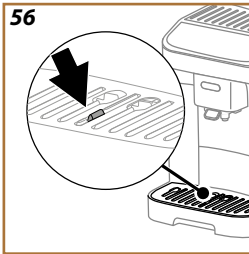

Drip tray and drip tray grille

The drip tray (A7) is fitted with a float level indicator (A13) (colour red) showing the amount of water it contains (fig. 56).

Before the indicator protrudes from the cup tray (A6), the drip tray must be emptied and cleaned, otherwise the water may overflow the edge and damage the appliance, the surface it rests on or the surrounding area. To remove the drip tray, proceed as follows:

1. Remove the drip tray with all its components (fig. 21).
2. Remove the grounds container (A11): empty the grounds container;
3. Remove the cup tray (A6) and the cup tray grille (A12) and wash all components thoroughly: the cup tray grille is not dishwasher safe;
4. Reposition the drip tray in the machine, complete with all its components.

Important!

When removing the drip tray, the coffee grounds container must always be emptied, even if it has not filled up noticeably. If this is not done, it can happen that when further coffees are prepared, the grounds container will fill up more than expected and clog the machine.

Inside of the machine

Danger of electric shock!

Before carrying out cleaning operations on internal parts, the machine must be turned off (see “Turning the machine off”) and unplugged from the mains power supply. Never immerse the machine in water

1. Check regularly (about once a month) that the inside of the appliance (accessible after removing the drip tray (A15)) is not dirty;
2. Remove all residues with a vacuum cleaner

Water tank

Periodically (about once a month) and whenever the water softener filter (D5) is replaced, clean the water tank (A9).

1. Take out the water tank, remove the water softener filter (if installed) and rinse with drinking water;
2. Empty the water tank and clean with warm water (40 °C approx), wiping if necessary with a clean, non-abrasive cloth. Rinse thoroughly under running water;
3. Reinstall the filter, if removed previously, then fill the water tank with fresh drinking water up to the MAX level and return it to the machine.
4. (Only if a water softener filter is installed) release 100ml of hot water to reactivate the filter.

Please note:

If the machine has not been used for more than 3 days, clean the water tank as described above.

Coffee spouts

1. Wipe the coffee spout (A5) regularly with a clean cloth;
2. Check that the holes in the coffee spout are not blocked. If necessary, remove coffee deposits with a toothpick.

Removable brewing unit

The brewing unit (A16) must be cleaned at least once a month.

Important!

The brewing unit cannot be removed while the machine is on.

1. Make sure the machine has run the shutdown procedure correctly (see heading “Turning the machine off”);
2. Remove the water tank (A9) (fig. 4);
3. Open the brewing unit flap (A14) (fig. 57) on the right of the machine by releasing the top catch;
4. Press the two coloured release buttons inwards (fig. 58) while at the same time pulling the brewing unit outwards;

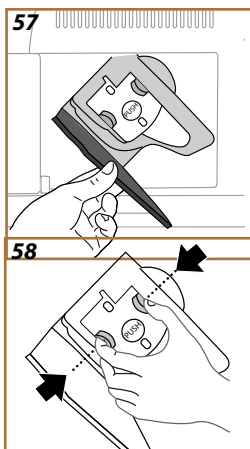

- Immerse the brewing unit in cold drinking water for about 5 minutes, then rinse under the tap;

Important!

RINSE WITH WATER ONLY
NO DETERGENTS - NO DISHWASHER

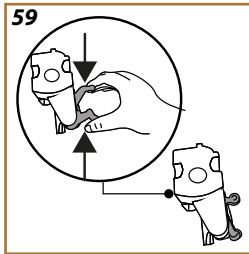

- Do not use detergents when cleaning the brewing unit, as they could damage it.
- Use a brush to remove any coffee residues left in the housing of the brewing unit, which can be seen through the relative flap;
- After cleaning, replace the brewing unit by sliding it into its housing, then apply pressure to the component until it clicks into place;

Please note:

If the brewing unit is difficult to fit, adapt it to the right size (before insertion) by applying pressure to the two levers (fig. 59).

- Once in position, make sure the two coloured buttons have snapped out (fig. 60);
- Close the brewing unit flap and ensure it is firmly in place;
- Reposition the water tank in the machine.

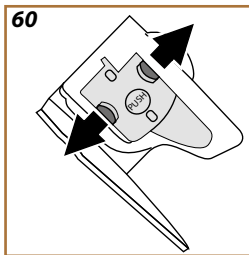

Pre-ground coffee funnel

Clean the pre-ground coffee funnel regularly (about once a month), using a brush. Proceed as follows

- Switch off the machine (see [“Turning the machine off”](#));
- Open the flap of the funnel (A2);
- Clean the funnel with a brush;
- Close the flap.

Important!

After cleaning, check that there are no accessories in the funnel. Ensure that there is no foreign matter in the funnel during operation, as this could damage the machine.

Control panel (B)

- Switch off the machine (see section [“Turning the machine off”](#));
- Wipe with a soft, non-abrasive cloth.
- Apply firm pressure to remove stubborn fingerprints, without using excessive force.

Thorough cleaning of milk carafe

This operation will guarantee optimum results over time. Proceed as follows:

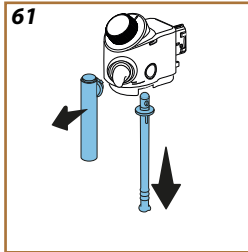

1. Press the release button (E4) and lift the lid (fig. 51).
2. Turn the milk delivery spout (E6) into an upright position and pull out until detached (fig. 61); pull the intake tube free (E7) (fig. 61).
3. Remove the connector (E5) by turning anticlockwise and pulling gently outwards (fig. 62).
4. Turn the dial (E2) to the "Remove" position and pull free (fig. 63).
5. Wash in a dishwasher (recommended) or by hand, as indicated below:

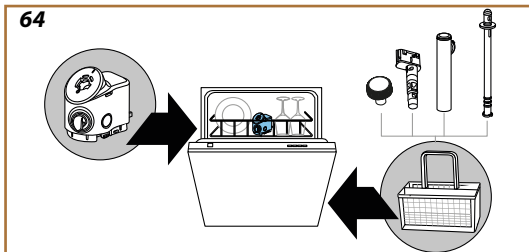
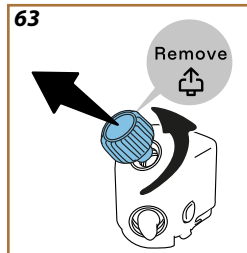
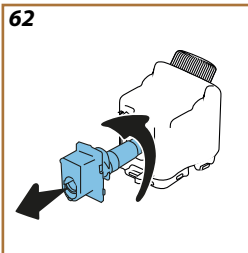

- In a dishwasher: Rinse all components with warm drinking water (at least 40 °C): place the lid of the carafe in the top basket of the dishwasher, standing upright on its edge, and the smaller detachable parts (outlet tube, intake tube, connector, dial) in the cutlery basket (fig. 64) . Run a wash program at 50 °C, e.g. Eco Standard
- By hand: Rinse all components carefully with warm drinking water (at least 40 °C) to ensure that all visible residues are removed: make sure the water passes

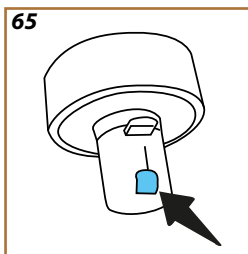

- through the holes. Immerse all components (including the milk container) in a solution of warm drinking water (at least 40° C) and washing-up liquid for at least 30 minutes. Rinse all components thoroughly with warm drinking water, rubbing them individually between fingers and thumbs.
6. Make sure there are no milk residues left in the cavity and the channel on the underside of the dial (fig. 65). If necessary, scrape with a toothpick.
 7. Check that the intake tube and the outlet tube are not clogged with milk residues;
 8. Dry the components with a clean dry cloth;
 9. Reassemble all components of the milk carafe.

Please note:

The machine will give a reminder periodically of the need for thorough cleaning of the milk carafe, and indicate the full sequence of steps.



Magnifica Evo Next Descaling

Important!

- Before use, read the instructions and the labelling on the descaler pack.
- Use only descaler supplied by De'Longhi. If unsuitable descaler is used, or descaling is not carried out properly and when required, the machine may develop faults not covered by the manufacturer's guarantee.
- Descaler can cause damage to delicate surfaces. If the product is accidentally spilt, dry immediately.

To descale	
Descaler	De'Longhi descaler (D4)
Container	Recommended capacity: 2 litres
Time	~25min

Descal the machine when the corresponding message appears on the homepage: to proceed with descaling straight away, press "OK" (B3) and follow the instructions step by step as indicated on the machine display (B11).

To delay descaling until later, press "↶" (B6): the homepage will continue to show the corresponding symbol (C2) as a reminder that descaling needs to be carried out. (The message reappears every time the machine is turned on).

To access the descaling menu:

1. Press the  button (B2).
2. Use the scroll arrows ">" (B4) or "<" (B5) to select "Maintenance". Press "OK" (B3).
3. Use the scroll arrows ">" (B4) or "<" (B5) to select "Descaling". Press "OK" to view the instructions.
4. Attach the hot water spout (D2) (fig. 7);
5. Remove and empty the drip tray (A7) and the coffee grounds container (A11) (fig. 21): then reposition both in the machine and press ">" (B4);
6. Remove the water tank (A9), lift the lid and (if inserted) remove the filter (D5). Empty the tank completely and press ">" (B4) to continue;
7. Pour the descaler (D4) into the water tank, filling up to level A marked on the inside of the tank (which is equivalent to one 100ml single-use pack), then add drinking water (one litre) up to level B (fig. 66). Reposition the water tank (with its lid) and press ">" (B4) (press "<" (B4) to go back to the previous screen or "↶" (B6) to exit the procedure, remembering in this instance to remove the descaling solution from the tank).

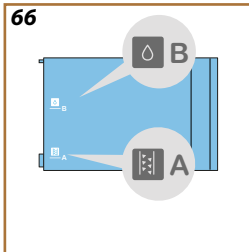

-
- Place an empty container of at least 2 litres capacity under the spouts (A5) and (D2) (fig. 9). Press "OK" (B3) to start the procedure.

Important! Danger of scalding

Hot water containing acid flows out of the spouts. Accordingly, take care to avoid contact with this solution.

- The descale programme starts and the descaler solution comes out of the hot water spout and the coffee spout; a succession of rinses is performed automatically at set intervals to remove the scale residues from inside the coffee machine;
After about 15 minutes, the descaling action ceases;
- The machine is now ready to be rinsed out with cold water. Empty the container used to collect the descaler solution. Remove and empty the water tank, rinse thoroughly under running drinking water, then fill the tank with cold water up to the MAX level and return it to the machine. Press ">" (B4)
- Having emptied the container used previously to collect the descaler solution, reposition it under the spouts and press "OK" (B3) to start the first rinse;
- Hot water is released both from the hot water spout and from the coffee spout;
- When the water in the tank has run out, empty the container used to collect the rinsing water;
- Take out the water tank and reposition the water softener filter, if removed previously. Press ">" (B4) to continue;
- Fill the tank with fresh water to the MAX level, and return it to the machine; Press ">" (B4) to continue;
- Having emptied the container used previously to collect the descaler solution, reposition it under the spouts and press "OK" (B3) to start another rinsing cycle;
- When the water in the tank has run out, empty the container used to collect the rinsing water, then remove the drip tray and the grounds container, empty them and return them to the machine: press "OK" (B3).
- Take out the water tank (A9), top up to the MAX level and reposition in the machine;
- The descaling procedure is now complete: press "OK" (B3) .

Please note:

- If the descaling cycle is not completed successfully (e.g., due to a power outage), the machine will prompt for the entire procedure to be repeated.
- Water may find its way into the grounds container (A11) during the descale procedure. This is quite normal.
- If the water tank (A9) was not filled to the MAX level for descaling, the machine requests a third rinse to guarantee that the descaler solution has been completely eliminated from its internal circuits. Before starting the rinse, remember to empty the drip tray (A7).

Magnifica Evo Next Frequent and alarm messages

Can you insert the water tank?

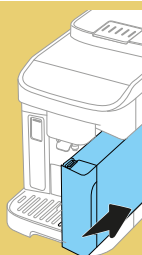

- The water tank (A9) is not in place
Reposition the tank in the machine correctly, and press fully home.

*Oops! it looks like you're out of coffee beans.
Time to add some more.*



- Coffee beans have run out.
Fill the bean container (A1) and press OK (B3) to resume preparation

*You haven't added the pre-ground coffee
Add it now
One scoop only!*

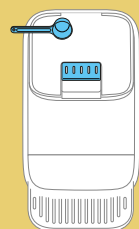

- Pre-ground coffee has been selected (☞) but pre-ground coffee has not been poured into the funnel.
Make sure when opening the flap (A2) that the funnel is not blocked, then put in one level scoop (D1) of pre-ground coffee and press OK (B3) to resume preparation



*I am unable to complete your drink.
Please empty the grounds container
and drip tray and try again*

- Too much coffee has been used.
Press OK (B3), remove the drip tray (A7) and the grounds container (A11), empty them both, then return all parts to the machine and repeat the preparation.



*I am unable to complete your drink.
Please reduce the pre-ground
quantity, empty the grounds
container and try again*

- Too much pre-ground coffee has been used
Press OK (B3), remove the drip tray (A7) and the grounds container (A11), empty them both, then return all parts to the machine and repeat the preparation, reducing the amount of pre-ground coffee (maximum 1 scoop).



*I am unable to complete your drink.
Adjust the coffee grinder by turning
the dial to give a finer setting, 1 step
at a time (+1)*

- The beans are too finely ground, so that the coffee is delivered too slowly or not at all.
Press "OK" (B3) and adjust the coffee grinder as appropriate (see section "Grinder").



*Sorry, I am unable to complete your
drink.
Please reduce the intensity and try
again*

- The beans are too finely ground, so that the coffee is delivered too slowly or not at all.
Press OK (B3) to go back to the homepage. Repeat the preparation, selecting a lower intensity setting from the customizations menu (see [Coffee-based drinks](#)).



*I am unable to complete your drink.
Please reduce the pre-ground coffee
quantity and try again*

- Too much pre-ground coffee has been used
Press OK (B3) and repeat the preparation, reducing the amount of pre-ground coffee (maximum 1 scoop).



Please empty the drip tray and the grounds container

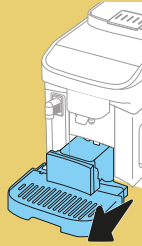

- The grounds container (A11) is full.
Clean as described in heading "Coffee grounds container"

Please insert the grounds container and drip tray

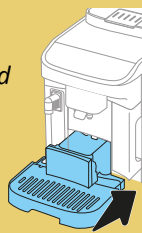

- The drip tray (A7) and/or the grounds container (A11) are not correctly in place, or missing
Refit the drip tray complete with grounds container and press fully home

Can you insert the brewing unit?

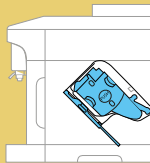

- The brewing unit has not been replaced after cleaning (A16)
Position the brewing unit as described in heading "Removable brewing unit"

Please insert the water spout

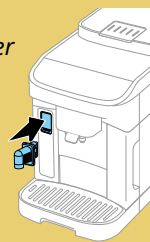

- Water spout (D2) not correctly in place, or missing.
Attach the water spout and push fully home: the machine emits a beep (if the beep function is enabled).



Can you insert the LatteCrema Hot carafe?

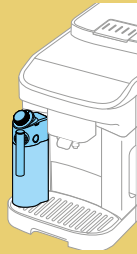

- Milk carafe (E) not positioned correctly, or missing. Position the milk carafe and push fully home: the machine emits a beep (if the beep function is enabled).

Time to clean the milk carafe Place a recipient under the milk spout. Ready?

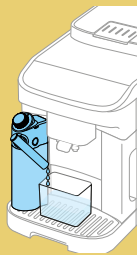

- Every time a milk-based drink has been prepared, the machine asks for the carafe (E) to be cleaned (Clean function). Proceed as described in section . [Cleaning the milk carafe after each use \(Clean function\)](#)

Remember to store the milk carafe in the fridge



- A milk-based drink has been prepared and the milk carafe (E) is still on the machine Remove the milk carafe and put it in the refrigerator.

Just doing a little cleaning. I'll be back in a few seconds

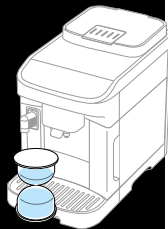

- The machine has detected impurities in its internal circuits. Wait until the machine is ready for use again and reselect the required drink. Contact an authorized Service Centre if the problem persists.





*It's time to replace your water filter.
Ready?*

- The water softener filter (D5) is spent.
Press "OK" (B3) to remove/replace the filter, or "↶" (B6) if the intention is to replace it later. Follow the instructions in heading [Water filter](#).

*The water circuit is out of water.
Ready to refill?*



- The water circuit is empty
Press "OK" (B3) to fill the circuit: the flow of water will stop automatically.
If the problem persists, make sure the water tank (A9) is pushed fully home.
- A new water softener filter has been fitted
Make sure that the instructions for installing the new filter (D5) (section [Water filter](#)) have been followed correctly. If the problem persists, remove the water filter.



*It's time to descale. Ready?
(25 min)*

- Indicates that the machine needs descaling.
To proceed with descaling, press "OK" (B3) and follow the guided procedure, otherwise press "↶" (B6): in this case the homepage (C) continues to display the  symbol (C2) as a reminder that descaling is required (see heading [Descaling](#)).



*Add De'Longhi descaler
(up to Level A), and
top up with water (to
level B)*

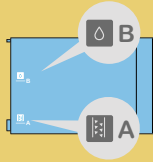

- During the guided procedure on preparation for the start of the descale cycle, the quantity of descaling solution put into the water tank was not sufficient. Prepare the solution as described in heading [Descaling](#)

*Time to fill the water
tank with fresh water.*



- Insufficient water in the tank. Remove the tank (A9) (fig. 4), fill with fresh drinking water up to the MAX level (fig. 5), and return it to the machine.
- Tank not correctly in place. Reposition the tank correctly and press fully home.



*Oops, the process has been interrupted.
Ready to continue?*

- Descaling interrupted or not completed correctly. Press OK (B3) to continue (see heading [Descaling](#)).
- Installation of filter interrupted or not completed correctly. Press OK to continue (see heading [Water filter](#)).



*Something's not right: can you refer to
the user manual please?*

- The inside of the machine is very dirty. Clean the inside of the machine thoroughly, as described in the heading [Cleaning the machine](#). If the message is still displayed after cleaning, contact De'Longhi Customer Services and/or an approved Service Centre

- Coffee not hot (1)

It has been 2-3 minutes since the last preparation and the internal circuit of the machine has cooled down: in this situation, a hot rinse is advisable.

On the homepage, press  to enter the settings menu:

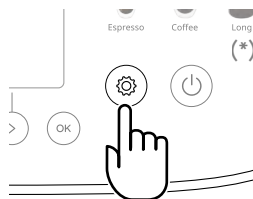

*Go to the “Maintenance” section, select the item **Rinsing** and proceed as indicated to start delivery. After a few seconds, hot water is released from the boiler to clean and heat the internal circuit of the machine.*

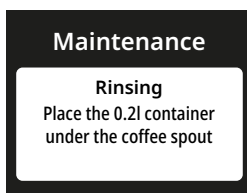

- Coffee not hot (2)

The cups have not been preheated.

Warm the cups by rinsing them with hot water.

*(Please note: the **Hot water** function can be used).*

- Coffee not hot (3)

The temperature set for preparation of the coffee is too low.

Select a higher temperature as indicated below:

On the homepage, press  to enter the settings menu:



Go to the “Preferences” section, select the item [Coffee temperature](#) and proceed as indicated to select a higher temperature.

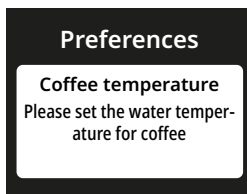

- Coffee not hot (4)

Descaling is required: proceed as illustrated in heading [Descaling](#).

This done, check that the water hardness setting is right for the water provided by your local supplier (see [Check the hardness of the water](#) and [Setting water hardness](#)).



-
- Coffee weak or not creamy enough (1)

The coffee is ground too coarsely. Adjust the grind level following the tips given below:

on the homepage, press  to enter the settings menu:



*Go to the section containing “Preferences”, select the item **Grinder** and proceed with adjustment of the grinder dial (A17) as indicated.*

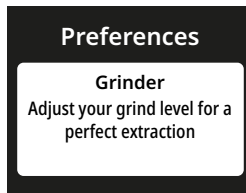

- Coffee weak or not creamy enough (2)

The coffee is unsuitable.

Use coffee for espresso machines.

- Coffee weak or not creamy enough (3)

The coffee is not fresh: the pack has been open too long and it has lost its flavour.

-
- Coffee delivered too slowly or drop-by-drop
*The coffee is ground too finely. Adjust the grind level following the tips given below:
on the homepage, press  to enter the settings menu:*



*Go to the section containing “Preferences”, select the item **Grinder** and proceed with adjustment of the grinder dial (A17) as indicated.*

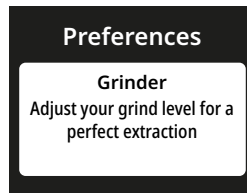

- Coffee does not come out of one or both spouts.. (A5)
The coffee spouts are blocked. Clean as described in section

 **COFFEE SPOUTS**



-
- The coffee delivered is watery

*The funnel is clogged.
Clean as described in section*

➔ PRE-GROUND COFFEE
FUNNEL

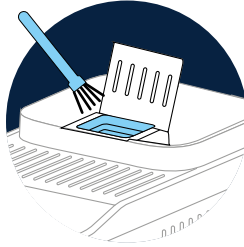



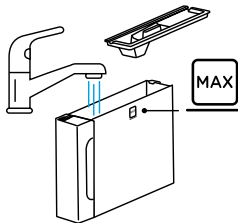

- Delivery of the drink short of measure

*The amount of water in the tank (A9) is not sufficient.
Always fill the tank at least to the MAX level*



-
- The brewing unit (A16) cannot be removed.
*The machine has not been turned off correctly.
Switch off by pressing  (B1) (see Turning the machine off)*
 - On completion of the descale cycle, the machine calls for a third rinse.
*During the two rinse cycles, the water tank (A9) has not been filled to the MAX level
Follow the procedure indicated by the machine, but first empty the drip tray (A7) to avoid water overflowing.*
 - The cup shelf (A3) is hot.
Several drinks have been prepared in rapid succession.
 - After cleaning, there is difficulty repositioning the drip tray (A7) in the machine.
*The condensate tray (A10) is not positioned correctly
Check that the condensate tray is correctly in place.*
 - The machine emits puffs of steam from the drip tray (A7) and/or there is water on the surface where the machine is positioned.
*The drip tray grille (A12) has not been replaced after cleaning.
Reposition the grille in the drip tray.*

- Milk presents large bubbles, or splashes from the milk spout (E6) or is under-frothed (1).

LatteCrema HOT	
 Cow's milk	
Whole (fat >3,5%)	✓
Semi-skimmed (fat between 1.5 and 1.8%)	
Skimmed (fat <0.5%)	
Vegetable drinks	
 Soya	✓
 Almond	✓
 Oatmeal	✓

Use cow's milk or vegetable drinks at refrigerator temperature (about 5° C).

If the result is still not as expected, try changing the brand of milk.

In the case of vegetable drinks, use "Barista" versions for best results.

- Milk presents large bubbles, or splashes from the milk spout (E6) or is under-frothed (2).

Clean the lid of the milk carafe (E1) thoroughly, as indicated in headings "Cleaning the milk carafe after each use (Clean function)" and "Thorough cleaning of milk carafe"

Magnifica Evo Next Technical data

Voltage:	220-240 V~ 50-60 Hz max. 10 A	
Power:	1450 W	
Pressure:	1.5 MPa (15 bars)	
Water tank capacity:	1.9l	
Size LxDxH:	240x440x360 mm	
Cord length:	1200 mm	
Weight:		9.6 kg
Bean container capacity:	250 g	

De'Longhi reserves the right to change the technical specification and styling of its products at any time, while maintaining their functionality and quality unaffected.

Tips for Energy Saving

- To reduce energy consumption, remove the milk carafe (E) after one or more drinks have been delivered;
- Set auto-off to 15 minutes (see section "Auto-off");
- Enable Energy Saving (see section "Energy saving");
- Always run the descaling procedure when prompted by the machine (see [Descaling](#)).

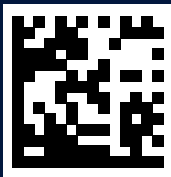

57132C9063_01_0524