

Register Now 
www.delonghi.com/register



ECAM35X.15

BEAN TO CUP ESPRESSO
AND CAPPUCCINO MACHINE

Instruction for Use

Instruction videos available at:
<http://ecam35015.delonghi.com>



DeLonghi

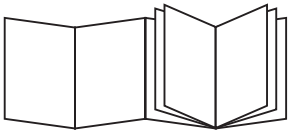

B

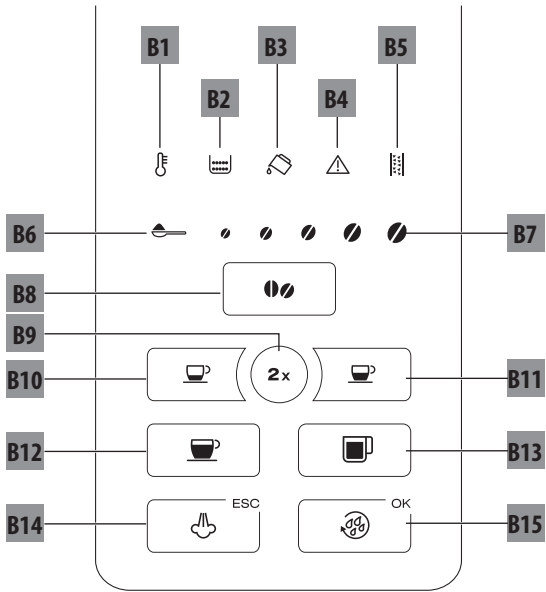

C

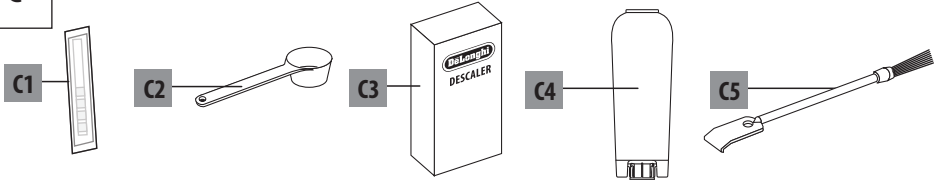

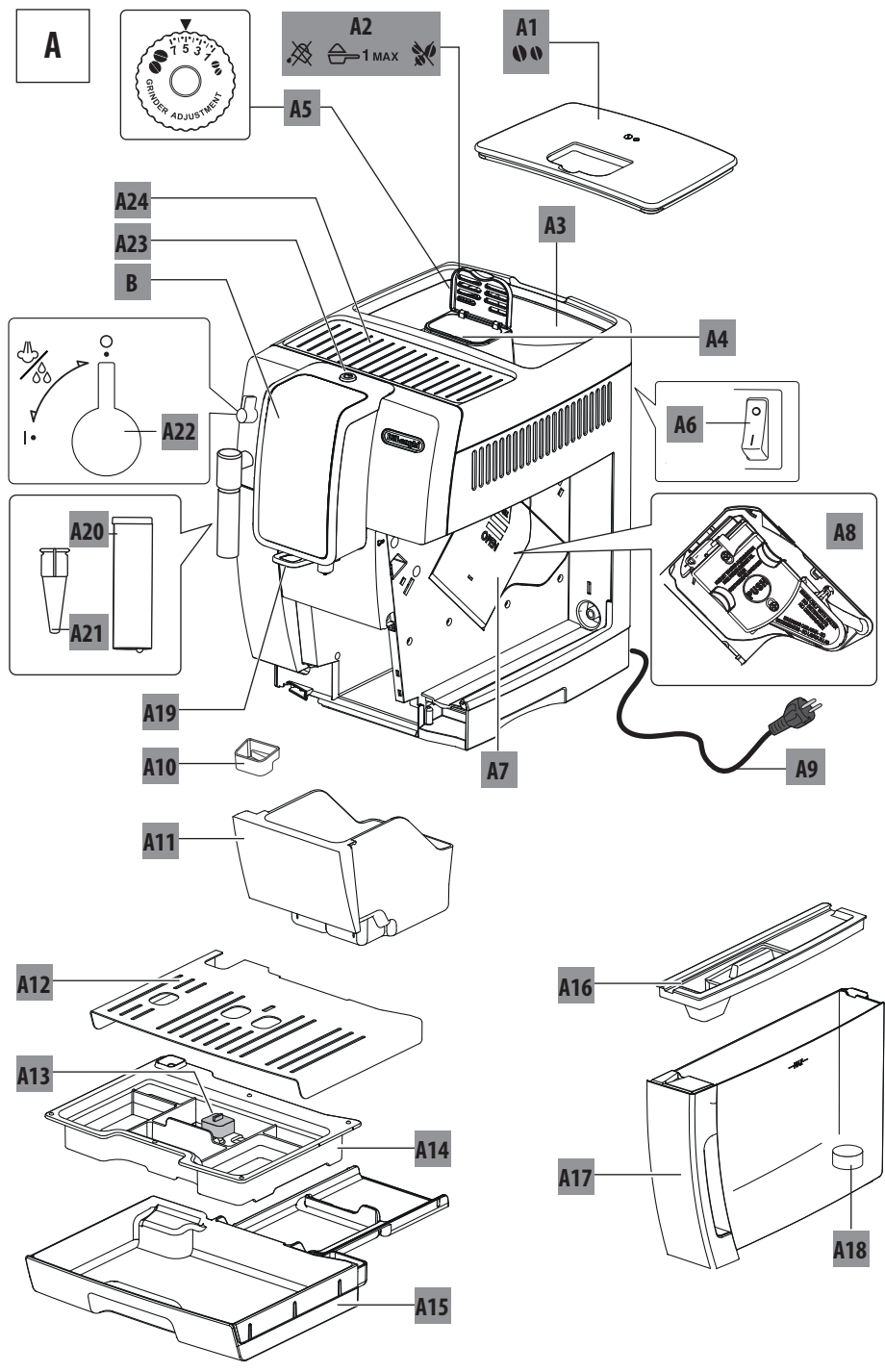

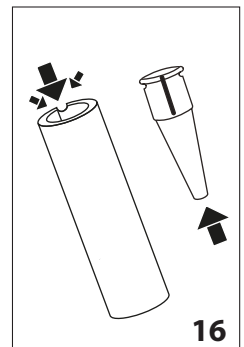
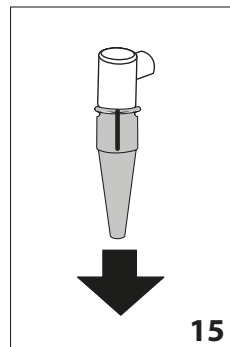
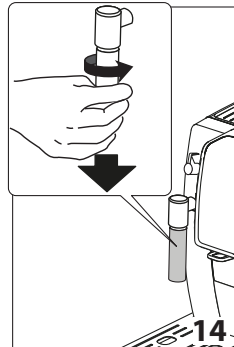
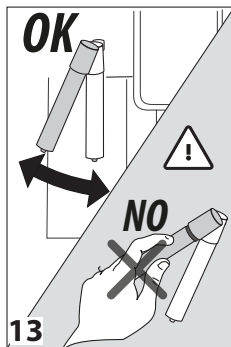
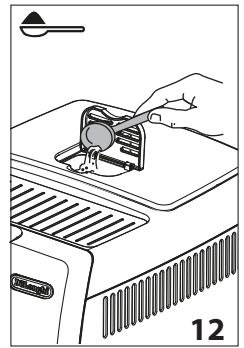
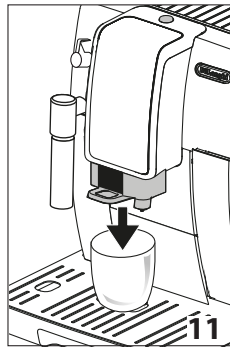
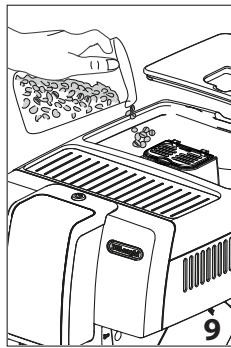
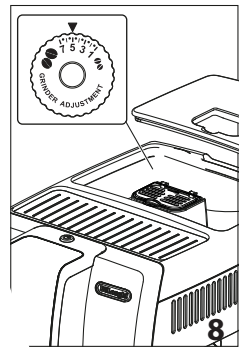
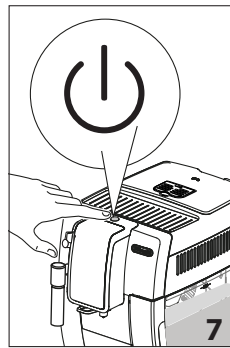
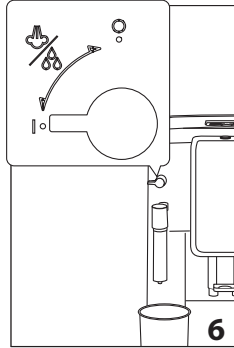
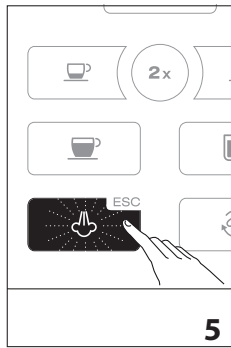
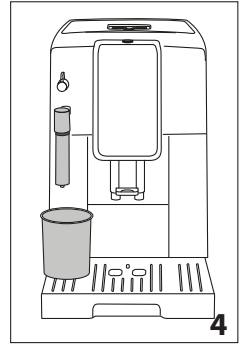
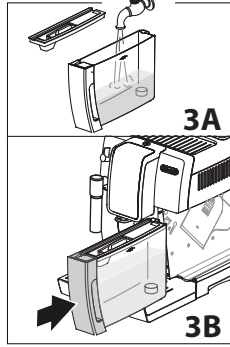
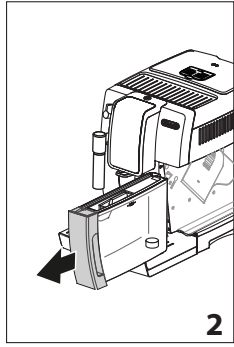
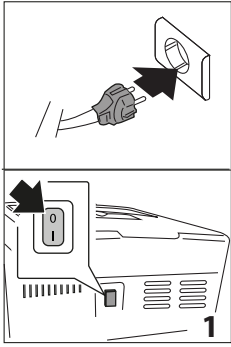

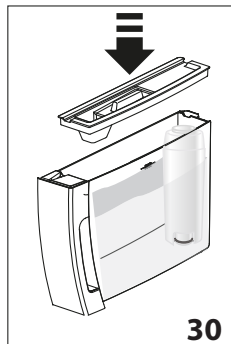
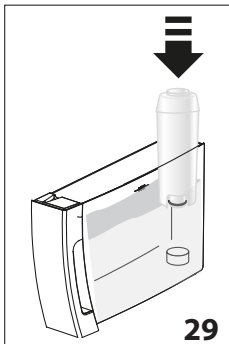
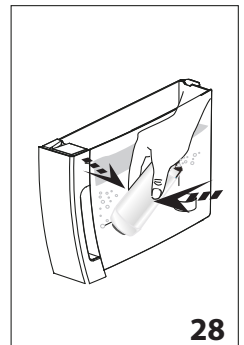
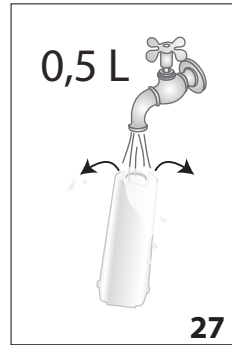
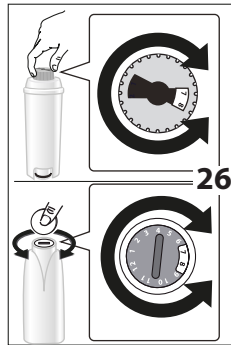
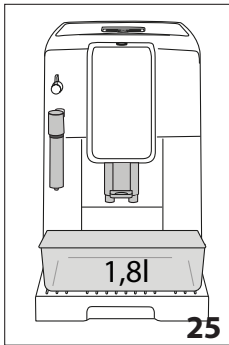
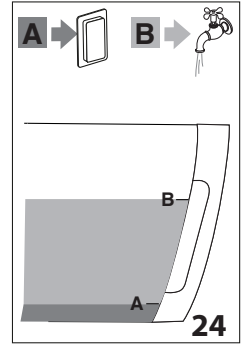
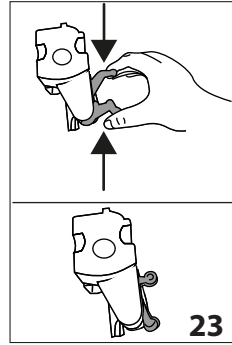
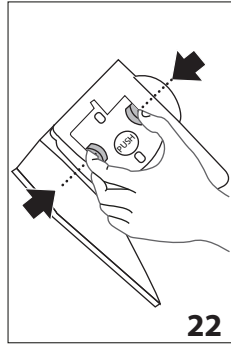
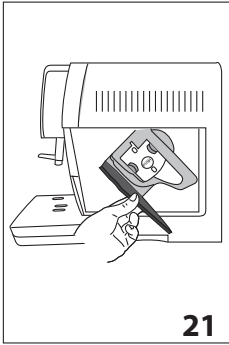
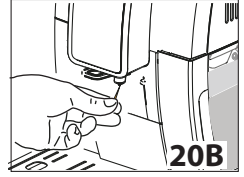
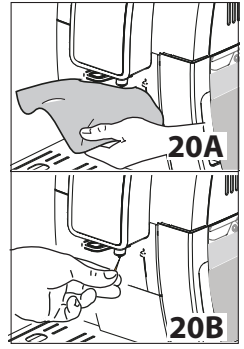
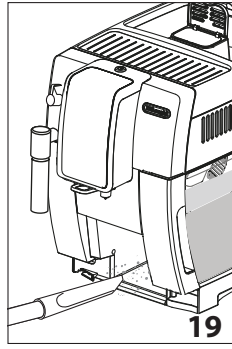
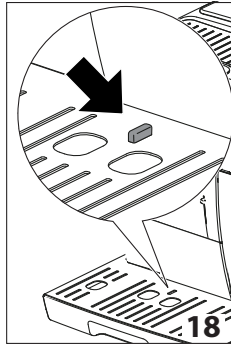
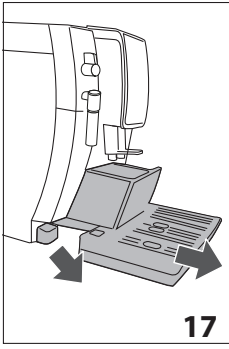

CONTENTS

1. FUNDAMENTAL SAFETY WARNINGS	7
2. SAFETY WARNINGS	8
2.1 Symbols used in these instructions	8
2.2 Designated use.....	8
2.3 Instruction for Use.....	8
3. INTRODUCTION	8
3.1 Letters in brackets	8
3.2 Troubleshooting and repairs.....	8
4. DESCRIPTION	9
4.1 Description of the appliance	9
4.2 Description of the touch screen	9
5. BEFORE USE	9
5.1 Checking the appliance	9
5.2 Installing the appliance.....	9
5.3 Connecting the appliance.....	9
5.4 Setting up the appliance	10
6. TURNING THE APPLIANCE ON	10
7. TURNING THE APPLIANCE OFF	10
8. SETTING WATER HARDNESS	10
9. SETTING TEMPERATURE	10
10. AUTO-OFF	11
11. ENERGY SAVING	11
12. BEEP	11
13. DEFAULT VALUES (RESET)	11
14. RINSING	12
15. MAKING COFFEE	12
15.1 Adjusting the coffee mill	12
15.2 Tips for a hotter coffee.....	12
15.3 Making coffee using coffee beans	12
15.4 Temporarily varying the coffee aroma.....	13
15.5 Making coffee using pre-ground coffee.....	13
15.6 Customising aroma and quantity	14
16. MAKING CAPPUCCINO	14
16.1 Cleaning the cappuccino maker after use	14
17. DELIVERING HOT WATER	15
18. CLEANING	15
18.1 Cleaning the machine	15
18.2 Cleaning the machine's internal circuit	15
18.3 Cleaning the coffee grounds container.....	15
18.4 Cleaning the drip tray and condensate tray.....	15
18.5 Cleaning the inside of the coffee machine...16	
18.6 Cleaning the water tank.....	16
18.7 Cleaning the coffee spouts	16
18.8 Cleaning the pre-ground coffee funnel	16
18.9 Cleaning the infuser	16
19. DESCALING	16
20. SETTING WATER HARDNESS	17
20.1 Measuring water hardness	17
20.2 Setting water hardness	18
21. WATER SOFTENER FILTER	18
21.1 Installing the filter	18
21.2 Replacing the filter.....	18
22. TECHNICAL DATA	18
23. DISPOSING OF THE APPLIANCE	18
24. EXPLANATION OF LIGHTS	19
25. TROUBLESHOOTING	21
26. ELECTRICAL REQUIREMENTS	23

1. FUNDAMENTAL SAFETY WARNINGS

- The appliance is not intended for use by persons (including children) with reduced physical, sensory or mental capabilities, or lack of experience and knowledge, unless they have been given supervision or instruction concerning use of the appliance by a person responsible for their safety.
- Children should be supervised to ensure that they do not play with the appliance.
- Designated use: this appliance is designed and made to prepare coffee and milk based beverages and hot water. Any other use is considered improper and thus dangerous. The manufacturer is not liable for damage deriving from improper use of the appliance.
- The surface of the heating element remains hot after use and the outside of the appliance may retain the heat for several minutes depending on use.
- To clean, follow the instructions in the section "11. CLEANING".
- Cleaning and user maintenance shall not be made by children without supervision.
- Never clean by immersing the appliance in water.
- CAUTION: To prevent damage to the appliance do not use alkaline cleaning agents when cleaning, use a soft cloth and a mild detergent
- This is a household appliance only. It is not intended to be used in: staff kitchen areas in shops, offices and other working environments; farm houses; by clients in hotels, motels and other residential type environments; bed and breakfast type environments.
- If the plug or cord is damaged, it must be replaced by Customer Services only to avoid all risk.
- Appliances with removable cord: avoid splashes of water on the power cord connector or socket at the back of the appliance.

FOR EUROPEAN MARKETS ONLY:

- This appliance can be used by children aged from 8 years and above if they have been given supervision or instruction concerning use of the appliance in a safe way and if they understand the hazard involved. Cleaning and user maintenance shall not be made by children unless they are older than 8 and supervised.
Keep the appliance and its cord out of the reach of children aged less than 8 years.
- Appliances can be used by persons with reduced physical, sensory or mental capabilities or lack of experience and knowledge if they have been given supervision or instruction concerning use of the appliance in a safe way and if they understand the hazards involved.
- Children shall not play with the appliance.

- When not in use and before putting on or taking off parts or cleaning, always unplug the appliance.



Surfaces marked with this symbol become hot during use (the symbol is present in certain models only).

2. SAFETY WARNINGS

2.1 Symbols used in these instructions

Important warnings are identified by these symbols. It is vital to respect these warnings.



Danger!

Failure to observe the warning may result in life threatening injury by electric shock.



Important!

Failure to observe the warning could result in injury or damage to the appliance.



Danger of burns!

Failure to observe the warning could result in scalds or burns.



Please note:

This symbol identifies important advice or information for the user.



Danger!

This is an electrical appliance and may cause electric shock. You should therefore follow these safety warnings:

- Never touch the appliance with damp hands or feet.
- Never touch the plug with damp hands.
- Make sure the socket used is freely accessible at all times, enabling the appliance to be unplugged when necessary.
- Unplug directly from the plug only. Never pull the cord as you could damage it.
- To disconnect the appliance completely you must unplug it from the mains socket.
- If the appliance is faulty, do not attempt to repair. Turn it off, unplug from the mains socket and contact Customer Services.
- Before cleaning the appliance, turn it off, unplug from the mains socket and allow to cool.



Important:

Keep all packaging (plastic bags, polystyrene foam) away from children.



Danger of burns!

This appliance produces hot water and steam may form while it is in operation.

Avoid contact with splashes of water or hot steam.

When the appliance is in operation, the cup shelf could become very hot.

2.2 Designated use

This appliance is designed and made to prepare coffee and heat beverages.

Any other use is considered improper and thus dangerous. The manufacturer is not liable for damage deriving from improper use of the appliance.

2.3 Instruction for Use

Read this Instruction for Use carefully before using the appliance. Failure to follow this Instruction for Use may result in burns or damage to the appliance.

The manufacturer is not liable for damage deriving from failure to respect this Instruction for Use.



Please note:

Keep these instructions for future use. If the appliance is passed to other persons, they must also be provided with this Instruction for Use.

3. INTRODUCTION

Thank you for choosing this bean to cup espresso and cappuccino machine.

We hope you enjoy using your new appliance. Take a few minutes to read this Instruction for Use. This will avoid all risks and damage to the appliance.

3.1 Letters in brackets

The letters in brackets refer to the legend in the description of the appliance (see pages 2-3).

3.2 Troubleshooting and repairs

In the event of problems, first try and resolve them by reading the information given in sections "24. Explanation of lights" and "25. Troubleshooting".

If this does not resolve the problem or you require further information, you should consult Customer Services by calling the number given on the annexed "Customer Service" sheet.

If your country is not among those listed on the sheet, call the number given in the guarantee. If repairs are required, contact De'Longhi Customer Services only. The addresses are given in the guarantee certificate provided with the machine.

4. DESCRIPTION

4.1 Description of the appliance











(page 3 - A)

- A1. Beans container lid
- A2. Pre-ground coffee funnel lid
- A3. Beans container
- A4. Pre-ground coffee funnel
- A5. Grinding adjustment dial
- A6. Main switch
- A7. Infuser door
- A8. Infuser
- A9. Power cord
- A10. Condensate tray
- A11. Coffee grounds container
- A12. Cup tray
- A13. Drip tray water level indicator
- A14. Drip tray grille
- A15. Drip tray
- A16. Water tank lid
- A17. Water tank
- A18. Water softener filter housing
- A19. Coffee spouts (adjustable height)
- A20. Cappuccino maker (removable)
- A21. Hot water and steam connection nozzle (removable)
- A22. Steam/hot water dial
- A23.  button: to turn the appliance on and off (standby)
- A24. Cup shelf

4.2 Description of the touch screen

(page 2 - B)

A number of icons on the touch screen have a double function. This is indicated in brackets in the description.

- B1.  light flashing: the appliance is heating up
- B2.  light:
 - on steadily: put the grounds container (A11) back
 - flashing: the grounds container needs emptying
- B3.  light:
 - on steadily: insert the water tank (A17)
 - flashing: insufficient water in the tank
- B4.  light: general alarm (see section "24. Explanation of lights")
- B5.  light:
 - on steadily: descaling programme underway
 - flashing: the appliance needs descaling
- B6.  : pre-ground function
- B7.  : coffee aroma
- B8.  : aroma selection
- B9.  : to deliver 2 cups of "espresso" or "espresso lungo"
- B10.  : "Espresso"
- B11.  : "Espresso Lungo"

B13.  : "Coffee"

B13.  : "Long"

- B14.  **ESC**:
- on steadily: to turn the steam function on (*when in the settings menu: press to exit the current programming*)
 - flashing: the steam/hot water dial (A22) must be turned

B15.  **OK**: to perform a rinse cycle.
(*When in the settings menu: press to confirm the current programming*)

Description of the accessories

(page 2 - C)

- C1. Indicator paper
- C2. Pre-ground coffee measure
- C3. Descaler
- C4. Water softener filter (certain models only)
- C5. Cleaning brush

5. BEFORE USE

5.1 Checking the appliance

After removing the packaging, make sure the product is complete and undamaged and that all accessories (C) are present. Do not use the appliance if it is visibly damaged. Contact De'Longhi Customer Services.

5.2 Installing the appliance

Important!

When you install the appliance, you should respect the following safety warnings:

- The appliance gives off heat. After positioning the appliance on the worktop, leave a space of at least 3 cm between the surfaces of the appliance and the side and rear walls and at least 15 cm above the coffee maker.
- Water penetrating the coffee machine could cause damage.
Do not place the appliance near taps or sinks.
- The appliance could be damaged if the water it contains freezes.
Do not install the appliance in a room where the temperature could drop below freezing point.
- Arrange the cord (A9) in such a way that it cannot be damaged by sharp edges or contact with hot surfaces (e.g. electric hot plates).

5.3 Connecting the appliance

Important!

Check that the mains power supply voltage corresponds to that indicated on the rating plate on the bottom of the appliance.

Connect the appliance to an efficiently earthed and correctly installed socket with a minimum current rating of 10A only. If the power socket does not match the plug on the appliance, have the socket replaced with a suitable type by a qualified professional.

5.4 Setting up the appliance



Please note:

- Coffee has been used to factory test the appliance and it is therefore completely normal for there to be traces of coffee in the mill. The machine is, however, guaranteed to be new.

You should customise water hardness as soon as possible following the instructions in section "20. Setting water hardness".

Proceed as described:

1. Plug the appliance into the mains socket and press the main switch (A6) on the back of the appliance (fig. 1).
2. The light (B3) flashes on the touch screen (B): Remove the water tank (A17 - fig. 2), fill to the MAX line with fresh water (fig. 3A) then put back in the appliance (fig. 3B).
3. The icon (B14 - fig. 5) flashes on the touch screen.
4. Place a container with a minimum capacity of 100 ml under the cappuccino maker (A20) (fig. 4).
5. Turn the steam/hot water dial to the "I" position (fig. 6) and press the **OK** icon (B15). Water is delivered from the cappuccino maker.
6. When delivery stops automatically, the icon flashes on the touch screen to indicate that the steam dial must be turned back to the "0" position.

The appliance goes off.

To use it, press the button (A23 - fig. 7).



Please note:

- The first time you use the appliance, you need to make 4-5 cups of coffee before it starts to give satisfactory results.
- To enjoy your coffee even more and improve the performance of your appliance, we recommend installing a water softener filter (C4) as described in section "21. Water softener filter". If your model is not provided with a filter, you can request one from De'Longhi Customer Services.

6. TURNING THE APPLIANCE ON



Please note:

Before turning the appliance on, make sure the main switch (A6) on the back of the appliance is pressed (fig. 1).

Each time the appliance is turned on, it performs an automatic preheat and rinse cycle which cannot be interrupted. The appliance is ready for use only after completion of this cycle.



Danger of burns!

During rinsing, a little hot water comes out of the coffee spouts (A19) and is collected in the drip tray (A15) underneath. Avoid contact with splashes of water.

- To turn the appliance on, press the button (A23) (fig. 7). The light (B1) flashes on the touch screen (B) to indicate the appliance is heating up.

While heating up, the machine performs a rinse cycle. As well as heating the boiler, this also heats the internal circuits by circulating hot water.

The appliance is at temperature when the light on the touch screen goes off and the coffee icons come on.

7. TURNING THE APPLIANCE OFF

Whenever the coffee machine is turned off after being used to make coffee, it performs an automatic rinse cycle.



Danger of burns!

During rinsing, a little hot water flows from the coffee spouts (A19). Avoid contact with splashes of water.

- To turn the appliance off, press the button (A23 - fig. 7);
- the light (B1) flashes on the touch screen and (if provided for) the appliance performs a rinse cycle then goes off (standby).



Please note!

If you will not be using the appliance for some time, unplug from the mains socket:

- first turn the appliance off by pressing the button (fig. 7);
- release the main switch (A6) (fig. 1).



Important!

Never press the main switch while the appliance is on.



8. SETTING WATER HARDNESS





For instructions on setting water hardness, see section "20. Setting water hardness".



9. SETTING TEMPERATURE

If you want to modify the temperature of the water used to make the coffee (low, medium, high, maximum), proceed as follows:

1. With the appliance off (standby), but the main switch pressed (fig. 1);

- Press and hold the **2x** icon (B9) until the lights on the touch screen (B) come on;
- Press the  icon (B10);
- Press the  icon again to select the required temperature:

	low
	medium
	high
	maximum



- Press the  **OK** icon (B15) to confirm (or  **ESC** (B14) to exit without making the change). The lights go off.





The appliance returns to "standby" and the temperature is now programmed.



10. AUTO-OFF

The time can be changed so that the appliance switches off after being idle for 15 or 30 minutes, or after 1, 2 or 3 hours.

To change the Auto-off setting, proceed as follows:







- With the appliance off (standby), but the main switch pressed (fig. 1);
- Press and hold the **2x** icon (B9) until the icons on the touch screen (B) come on;
- Press the  icon (B11);
- Select the required time interval by pressing the  icon again:

	15 min.
	30 min.
	1 hour
	2 hours
	3 hours

- Press the  **OK** icon (B15) to confirm (or  **ESC** (B14) to exit without making the change). The lights go off. The auto-off time is now programmed.

11. 11. ENERGY SAVING

Use this function to enable or disable energy saving. This mode is active by default, reducing energy consumption while the machine is on in compliance with current European regulations. To change the setting, proceed as follows:





- With the appliance off (standby), but the main switch pressed (fig. 1);
- Press and hold the **2x** icon (B9) until the icons on the touch screen (B) come on.
- Press the  icon (B13);
- Press the  icon again to enable/disable the function:
 -  function enabled
 -  function disabled
- Press the  **OK** icon (B15) to confirm (or  **ESC** (B14) to exit without making the change).
- Press  **ESC** to exit the menu. The lights go off. The energy saving setting is now programmed.

Please note!

- When in energy saving mode, a few seconds may elapse before the first coffee is delivered as the appliance must heat up again.

12. 12. BEEP



This function enables or disables the beep. Proceed as follows:

- With the appliance off (standby), but the main switch pressed (fig. 1);
- Press and hold the **2x** icon (B9) until the lights on the touch screen (B) come on.
- Press the **2x** icon to enable/disable the function:
 -  function enabled
 -  function disabled
- Press the  **OK** icon (B15) to confirm (or  **ESC** (B14) to exit without making the change). The lights go off. The beep is now programmed.

13. 13. DEFAULT VALUES (RESET)

This function resets all settings (temperature, auto-off, water hardness, energy saving and all quantity settings are reset to the default values).

- With the appliance off (standby), but the main switch pressed (fig. 1);
- Press and hold the **2x** icon (B9) until the lights on the touch screen (B) come on.

- Press the  icon (B12). The beans (B7) on the touch screen flash;
- Press the  **OK** icon (B15) to reset the default values (or  **ESC** (B14) to exit without making the change). The lights go off.

The settings and quantities of the beverages have been reset to the default values.

14. RINSING



Use this function to deliver hot water from the coffee spouts (A19) to clean and heat the appliance's internal circuit.

Place a container with a minimum capacity of 100ml under the coffee and hot water spouts.



Important! Danger of burns.

Do not leave the appliance unattended while hot water is being delivered.

- To activate the function, press  **OK** (B15);
- After a few seconds, hot water is delivered from the coffee spouts, cleaning and heating the appliance's internal circuit.
- To interrupt the function manually, press  **OK** again.



Please note!

- If the appliance is not used for more than 3-4 days, when switched on again, we strongly recommend performing 2/3 rinses before use;
- After cleaning, it is normal for the coffee grounds container (A11) to contain water.

15. MAKING COFFEE

15.1 Adjusting the coffee mill

The coffee mill is set by default to prepare coffee correctly and should not require regulating initially.

However, if after making the first few coffees you find that the coffee is either too weak and not creamy enough or delivery is too slow (a drop at a time), this can be corrected by calibrating the coffee grinding using the adjusting dial (A5) (fig. 8).



Please note:

The grinding adjustment dial must only be turned when the coffee mill is in operation.

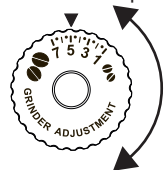

If the coffee is delivered too slowly or not at all, turn one click clockwise towards 7. For fuller bodied creamier coffee, turn one click anticlockwise towards 1 (do not turn more than one click at a time otherwise the coffee could be delivered a drop

at a time).

These adjustments will only be evident after at least 2 cups of coffee have been delivered. If this adjustment does not obtain the desired result, turn the dial another click.

15.2 Tips for a hotter coffee

For hotter coffee, you should:

- perform a rinse cycle by pressing  **OK** (B15);
- warm the cups with hot water using the hot water function (see section "17. Delivering hot water");
- increase the coffee temperature (see section "8. Setting water hardness").











15.3 Making coffee using coffee beans





Important!

Do not use green, caramelised or candied coffee beans as they could stick to the coffee mill and make it unusable.



- Fill the container (A3) (fig. 9) with coffee beans;
- Place under the coffee spouts (A19):
 - 1 cup, if you want to make 1 coffee (fig. 10);
 - 2 cups if you want 2 coffees.
- Lower the spouts as near as possible to the cup. This makes a creamier coffee (fig. 11);
- Then select your required coffee:

Recipe	Quantity	Program- mable quantity	Default aroma
 Espresso (B10)	≈ 40 ml	from ≈30 to ≈ 80ml	
 Espresso Lungo (B11)	≈ 120 ml	from ≈80 to ≈180c	
 Coffee (B12)	≈ 180 ml	from ≈100 a ≈240cc	
 Long (B13)	≈ 160 ml	from ≈115 to ≈250cc	
2x (B9) +  Espresso (B10)	≈ 40 ml x 2 cups	--	



2x (B9) +  Espresso Lungo (B11)	≈ 120 ml x 2 cups	--	
---	----------------------	----	--

5. Preparation begins and the light corresponding to the selected icon flashes on the touch screen (B).

i Please note:

- To make 2 cups of "espresso" or "espresso lungo" at the same time:
 - Press the "2X" icon (B9). The icons corresponding to the beverages available for selection light up and the "2X" icon flashes. Press  or : Preparation begins.

Alternatively, proceed as follows:

- Press  or : preparation begins and the "2X" icon flashes for a few seconds. Press the "2X" icon while it is flashing.

- While the machine is making coffee, delivery can be interrupted at any moment by pressing the coffee icon.

At the end of delivery, to increase the quantity of coffee in the cup, within 3 seconds just press one of the coffee icons (B10 - B13).



Once the coffee has been made, the appliance is ready to make the next beverage.



i Please note:

- Lights may be displayed on the touch screen (B) during use. Their meaning is given in section "24. Explanation of lights".
- For hotter coffee, see section "15.2 Tips for a hotter coffee".
- If the coffee is delivered a drop at a time, too weak and not creamy enough or too cold, read the tips in section "25. Troubleshooting".
- To customise the beverages according to personal taste, see section "18. Cleaning".

15.4 Temporarily varying the coffee aroma

To temporarily vary the coffee aroma, press  (B8):

	EXTRA LIGHT
	LIGHT
	MEDIUM

	STRONG
	X-STRONG
	(see "15.5 Making coffee using pre-ground coffee")

i Please note:

- The variation in aroma is not saved and the next time a beverage is delivered automatically, the appliance selects the default value.
- If a few seconds elapse between temporary customising of the aroma and delivery of the beverage, the aroma returns to the default value.

15.5 Making coffee using pre-ground coffee



! Important!





- Never add pre-ground coffee when the machine is off or it could spread through the inside of the machine and dirty it. This could damage the appliance.
- Never use more than 1 level measure (C2) or it could dirty the inside of the coffee machine or block the funnel (A4).



i Please note:

If you use pre-ground coffee, you can only make one cup of coffee at a time.



- Press the  icon (B8) repeatedly until the  light (B6) comes on.
- Make sure the funnel is not blocked, then add one level measure of pre-ground coffee (fig. 12).
- Place a cup under the coffee spouts (A19) (fig. 10).
- Then select your required coffee:

Recipe	Quantity
 Espresso (B10)	≈ 40 ml
 Espresso Lungo (B11)	≈ 120 ml
 Coffee (B12)	≈ 180 ml
 Long (B13)	≈ 160 ml

- Preparation begins and the light corresponding to the selected icon flashes on the touch screen (B).



Important! Making LONG coffee

Halfway through preparation, the  light flashes. Add one level measure of pre-ground coffee and press  **OK** (B15).



Please note:

If "Energy Saving" mode is active, you may have to wait a few seconds before the first coffee is delivered.

15.6 Customising aroma and quantity

The appliance is set by default to make coffee with a standard aroma and quantity (see table in section "15.3 Making coffee using coffee beans").

To customise the coffee, proceed as follows:

- Place a sufficiently large cup or glass under the coffee spouts (A19);
- Press  (B8) to select the required aroma (see section "15.4 Temporarily varying the coffee aroma");
- Press and hold the icon corresponding to the coffee to be customised. The icon flashes and all the alarm lights flash 4 times;
- Release the icon. The icon flashes and the appliance starts delivering coffee;
- As soon as the coffee in the cup reaches the required level, press the coffee icon again.

The aroma and quantity of coffee in the cup has now been programmed.

16. MAKING CAPPUCCINO



Danger of burns!

During preparation steam is given off. Take care to avoid scalds.

- When preparing cappuccino, make the coffee in a large cup.
- Fill a container (preferably one with a handle to avoid scalding) with about 100 grams of milk for each cappuccino. In choosing the size of the container, bear in mind that the milk doubles or triples in volume.



Please note:

For a richer denser froth, use skimmed or partially skimmed milk at refrigerator temperature (about 5°C). To avoid milk with poor froth or large bubbles, always clean the cappuccino maker as described in section "16.1 Cleaning the cappuccino maker after use".





- The cappuccino maker (A20) can be turned slightly upwards to allow containers of any size to be used.

- Immerse the cappuccino maker in the milk container. Never immerse the black ring.



Important!

Never use force to turn the cappuccino maker (fig. 13). It could break!

- Press the  icon (B14). The  light (B1) flashes to indicate the appliance is heating up.
- When the appliance is at temperature, the  light goes off and the  icon flashes.
- Turn the steam/hot water dial  (A22) to the **I** position. After a few seconds, steam is delivered from the cappuccino maker, giving the milk a creamy frothy appearance and making it more voluminous. For a creamier froth, rotate the container with slow movements in an upward direction.
- When you have obtained the required froth, stop steam delivery by turning the dial to the "0" position.



Danger of burns!

Interrupt steam delivery before removing the container with the frothed milk to avoid burns caused by splashes of boiling milk.

- Add the milk froth to the coffee prepared previously. The cappuccino is ready. Sweeten to taste and, if desired, sprinkle the froth with a little cocoa powder.



Please note!

If "Energy saving" is active, you may have to wait a few seconds before steam is delivered.

16.1 Cleaning the cappuccino maker after use

Clean the cappuccino maker (A20) each time you use it to avoid the build-up of milk residues or blockages.



Danger of burns!

When cleaning the cappuccino maker, a little hot water is delivered. Avoid contact with splashes of water.



- Deliver a little water by turning the steam/hot water dial  (A22) to the **I** position. Then stop delivery by turning the dial back to the **0** position.
- Wait a few minutes for the cappuccino maker to cool down, then rotate the cappuccino maker anticlockwise and extract downwards (fig. 14).
- Remove the connection nozzle downwards (A21 - fig. 15).
- Make sure the two holes shown by the arrow in fig. 16 are not blocked. If necessary, clean with a pin.
- Reinsert the connection nozzle and replace the cappuccino maker on the nozzle, pushing it upwards and turning it until it is attached.

17. DELIVERING HOT WATER



Important! Danger of burns.

Never leave the machine unattended while delivering hot water. The spout of the cappuccino maker (A20) becomes hot during delivery.

1. Place a container under the cappuccino maker (A20) (as close as possible to avoid splashes).
2. Turn the steam/hot water dial  (A22) to the **I** position.
3. To stop hot water delivery manually, turn the steam/hot water dial  to the **0** position.



Please note!

If “Energy Saving” is active, you may have to wait a few seconds before hot water and steam are delivered.

18. CLEANING

18.1 Cleaning the machine

The following parts of the machine must be cleaned regularly:

- the appliance's internal circuit;
- coffee grounds container (A11);
- drip tray (A15) and condensate tray (A10);
- water tank (A17);
- coffee spouts (A19);
- cappuccino maker (A20 - “16.1 Cleaning the cappuccino maker after use”);
- pre-ground coffee funnel (A4);
- infuser (A8), accessible after opening the infuser door (A7);
- touch screen (B).



Important!

- Do not use solvents, abrasive detergents or alcohol to clean the coffee machine. With De'Longhi superautomatic coffee machines, you need not use chemical products to clean the machine.
- None of the components of the appliance can be washed in a dishwasher with the exception of the drip tray grille (A14).
- Do not use metal objects to remove encrustations or coffee deposits as they could scratch metal or plastic surfaces.

18.2 Cleaning the machine's internal circuit

If the appliance is not used for more than 3/4 days, before using it again, we strongly recommend switching it on and:

- performing 2/3 rinse cycles by pressing  (B15);
- delivering hot water for a few seconds (section “17. Delivering hot water”).



Please note:

After cleaning, it is normal for the coffee grounds container (A11) to contain water.

18.3 Cleaning the coffee grounds container

When the  light (B2) flashes, the coffee grounds container (A11) must be emptied and cleaned. The appliance cannot be used to make coffee until you have cleaned the grounds container. Even if not full, the empty grounds container message appears on the display 72 hours after the first coffee has been prepared. For the 72 hours to be calculated correctly, the machine must never be turned off with the main switch (A6).



Important! Danger of burns

If you make a number of cappuccinos one after the other, the metal cup tray (A12) becomes hot. Wait for it to cool down before touching it and handle it from the front only.

To clean (with the machine on):

- Remove the drip tray (A15) (fig. 17), empty and clean.
- Empty the grounds container (A11) and clean thoroughly to remove all residues left on the bottom.
- Check the condensate tray (A10) (red) and empty if necessary.

18.4 Cleaning the drip tray and condensate tray



Important!

The drip tray (A15) is fitted with a level indicator (A13) (red) showing the level of water it contains (fig. 18). Before the indicator protrudes from the cup tray (A12), the drip tray must be emptied and cleaned otherwise the water may overflow the edge and damage the appliance, the surface it rests on or the surrounding area.

To remove the drip tray:

1. Remove the drip tray and the coffee grounds container (A11) (fig. 17);
2. Remove the cup tray (A12) and drip tray grille (A14), then empty the drip tray and grounds container and wash all components;
3. Check the red condensate tray (A10) and empty if necessary;
4. Replace the drip tray complete with grille and grounds container.



Important!

When removing the drip tray, the grounds container must be emptied, even if it contains few grounds.

If this is not done, when you make the next coffees, the grounds container may fill up more than expected and clog the machine.

18.5 Cleaning the inside of the coffee machine



Danger of electric shock!

Before cleaning internal parts, the machine must be turned off (see section "7. Turning the appliance off") and unplugged from the mains power supply. Never immerse the coffee machine in water.

1. Check regularly (about once a month) that the inside of the appliance (accessible after removing the drip tray (A15)) is not dirty. If necessary, remove coffee deposits with the brush (C5) and a sponge;
2. Remove all the residues with a vacuum cleaner (fig. 19).

18.6 Cleaning the water tank

1. Clean the water tank (A17) regularly (about once a month) and whenever you replace the water softener filter (C4) (if provided) with a damp cloth and a little mild washing up liquid;
2. Remove the filter (C4) (if present) and rinse with running water;
3. Replace the filter (if provided), fill the tank with fresh water and replace the tank;
4. (Models with water softener filter only) Deliver about 100ml of water.

18.7 Cleaning the coffee spouts

1. Clean the coffee spouts (A19) regularly with a sponge or cloth (fig. 20A);
2. Check that the holes in the coffee spouts are not blocked. If necessary, remove coffee deposits with a toothpick (fig. 20B).

18.8 Cleaning the pre-ground coffee funnel

Check regularly (about once a month) that the pre-ground coffee funnel (A4) is not blocked. If necessary, remove coffee deposits with the brush (C5).

18.9 Cleaning the infuser

The infuser (A8) must be cleaned at least once a month.



Important!

The infuser may not be extracted when the machine is on.

1. Make sure the machine is correctly turned off (see section "7. Turning the appliance off");
2. Remove the water tank (A17);
3. Open the infuser door (A7) (fig. 21) on the right side of the appliance;
4. Press the two coloured release buttons inwards and at the same time pull the infuser outwards (fig. 22);

5. Soak the infuser in water for about 5 minutes, then rinse under the tap;



Important!

RINSE WITH WATER ONLY

NO WASHING UP LIQUID - NO DISH WASHER

Clean the infuser without using washing up liquid as it could be damaged.

6. Use the brush (C5) to remove any coffee residues left in the infuser housing, visible through the infuser door;
7. After cleaning, replace the infuser by sliding it onto the internal support, then push the PUSH symbol fully in until it clicks into place;





Please note:



If the infuser is difficult to insert, before insertion, adapt it to the right size by pressing the two levers (fig. 23).

8. Once inserted, make sure the two coloured buttons have snapped out;
9. Close the infuser door;
10. Put the water tank back.

19. DESCALING

Descal the appliance when the  light (B5) on the touch screen (B) flashes and only the  OK (B15) and  ESC icons (B14) remain on.

To descale immediately, press  OK and follow the instructions from point 4.





To descale the appliance later, press  ESC. The  light flashes on the touch screen to remind you that the appliance needs descaling.



Important!

- Before use, read the instructions and the labelling on the descaler pack.
- You should use De'Longhi descaler only. Using unsuitable descaler and/or performing descaling incorrectly may result in faults not covered by the manufacturer's guarantee.





To descale the appliance, proceed as follows:

1. Turn the appliance off (standby) by pressing the  button (A23 - fig. 7) (see section "7. Turning the appliance off");
2. Empty the drip tray (A15) and grounds container (A11) and put both back in the machine;
3. Press and hold the  icon (B8) until the  light (B5) and the  ESC and  OK icons light up;
4. Empty the water tank (A17) completely and remove the water softener filter (C4), if present;







- Pour the descaler (C3) into the tank up to level A (corresponding to a 100ml pack) marked on the inner surface of the tank, then add a litre of water up to level B (fig. 24) and put the water tank back in the appliance;
- Place a container with a minimum capacity of 1.8 litres under the cappuccino maker (A20) and coffee spouts (A19) (fig. 25);



 **Important! Danger of burns**

Hot water containing acid flows from the cappuccino maker and coffee spouts. Take care to avoid contact with splashes of this solution.

- Press the  **OK** icon to confirm that you have added the descaler solution. The descaling procedure begins;
- After a few minutes, the  **ESC** icon (B14) flashes to indicate the steam/hot water dial  (A22) must be turned to the  position;
- When the dial has been turned to the **I** position, the descale programme starts and the descaler liquid comes out of the cappuccino maker. A series of rinses and pauses are performed automatically to remove all the scale residues inside the coffee machine;

After about 35 minutes, the appliance interrupts descaling and the  light (B3) flashes.

- The appliance is now ready for rinsing through with clean water. Empty the container used to collect the descaler solution. Extract the water tank, empty, rinse under running water, fill with fresh water up to the MAX level and put back in the appliance;
- Place the container used to collect the descaler solution empty under the coffee spouts and cappuccino maker (fig. 25);
- Press the  **OK** icon:  **ESC** flashes to indicate the steam/hot water dial  must be turned to the **0** position;
- Turn the steam/hot water dial  to the **0** position to start rinsing. Hot water comes out of the coffee spouts;
- After a preset time,  **ESC** flashes. Turn the dial to the **I** position. Delivery continues from the cappuccino maker. When the water in the tank has run out, the  light (B3) comes on;
- The appliance is now ready for a second rinse with clean water. Empty the container used to collect the rinse water. Extract the water tank, empty, rinse under running water, fill with fresh water up to the MAX level, replace the water softener filter (if previously removed) and put back in the appliance;

- Place the container used to collect the rinsing water empty under the cappuccino maker;
- Press the  **OK** icon. The appliance begins rinsing again from the cappuccino maker only;
- When the water in the tank has run out, the  light flashes;
- Empty the container used to collect the rinse water, remove the water tank and fill with fresh water up to the **MAX** level, then put back in the appliance. The  **ESC** icon flashes;
- Turn the dial to the **0** position;
- Empty and replace the drip tray (A15) and grounds container (A11).

Descaling is complete.

 **Please note!**

- If the descaling cycle is not completed correctly (e.g. no electricity) we recommend repeating the cycle;
- After descaling, it is normal for the grounds container (A11) to contain water;
- If the water tank has not been filled to the MAX level, at the end of descaling, the appliance requests a third rinse to guarantee that the descaler solution has been completely eliminated from the machine's internal circuits.



20. SETTING WATER HARDNESS







The  light (B5) comes on after a period of time established according to water hardness.

The machine is set by default for a hardness level of 4. The machine can also be programmed according to the hardness of the mains water in the various regions so that the machine needs to be descaled less often.





20.1 Measuring water hardness

- Remove the "TOTAL HARDNESS TEST" indicator paper (C1) from its pack (attached to the English instructions);
- Immerse the paper completely in a glass of water for one second;
- Remove the paper from the water and shake lightly. After about a minute, 1, 2, 3, or 4 red squares form, depending on the hardness of the water. Each square corresponds to 1 level;

Indicator paper	Water hardness	Corresponding setting
	low	

	medium	
	high	
	maximum	

20.2 Setting water hardness

1. With the appliance off (standby), but the main switch pressed (fig. 1);
2. Press and hold the **2x** icon (B9) until the icons on the touch screen (B) come on;
3. Press the  icon (B8);
4. Select the water hardness level by pressing the  icon again :
5. Press the  **OK** icon (B15) to confirm (or  **ESC** (B14) to exit without making the change). The lights go off. The machine is now reprogrammed with the new water hardness setting.

21. WATER SOFTENER FILTER

Certain models are fitted with a water softener filter (C4). If this is not the case with your model, you are recommended to purchase one from De'Longhi Customer Services.

To use the filter correctly, follow the instructions below.



21.1 Installing the filter

1. Remove the filter (C4) from the packaging. The date indicator disk varies according to the filter provided (fig. 26);
2. Turn the date disk to display the next 2 months of use.

Please note

The filter lasts about two months if the appliance is used normally. If the coffee machine is left unused with the filter installed, it will last a maximum of 3 weeks.

3. To activate the filter, run tap water through the hole in the filter as shown in fig. 27 until water comes out of the openings at the side for more than a minute;
4. Extract the tank (A17) from the appliance and fill with water;
5. Insert the filter in the water tank and immerse it completely for about ten seconds, sloping it and pressing it lightly to enable the air bubbles to escape (fig. 28).
6. Insert the filter in the filter housing (A18) and press as far as it will go (fig. 29);
7. Close the tank with the lid (A16 - fig. 30), then replace the tank in the machine;

8. Position a container with a minimum capacity of 500ml under the cappuccino maker/hot water spout (A20).
9. Deliver hot water by turning the steam/hot water dial  (A22) to the **I** position.
10. Deliver at least 500 ml of hot water, then turn the steam/hot water dial  to the **0** position.

The filter is now active and you can use the coffee machine.

21.2 Replacing the filter

After two months (see date indicator) or when the appliance has not been used for 3 weeks, you should replace the filter:

1. Extract the tank (A17) and exhausted filter (C4);
2. Take the new filter out of its packet and proceed as described in points 2 to 10 in the previous section.

The new filter is now active and you can use the coffee machine.

22. TECHNICAL DATA

Voltage:	220-240 V~ 50/60 Hz max. 10A
Absorbed power:	1450W
Pressure:	1.5MPa (15 bars)
Max. water tank capacity:	1.8 L
Size LxDxH:	240x440x360 mm
Cord length:	1150 mm
Weight:	9.2 kg
Max. beans container capacity:	300 g









 This appliance complies with European regulation no. 1935/2004 on food contact materials.





23. DISPOSING OF THE APPLIANCE





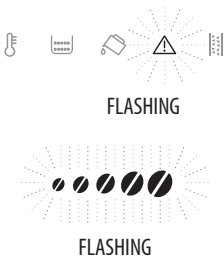
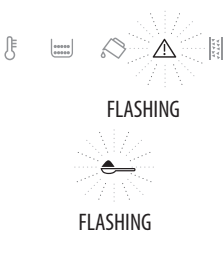
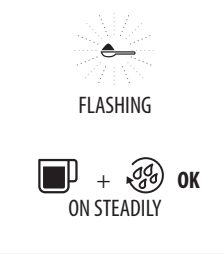

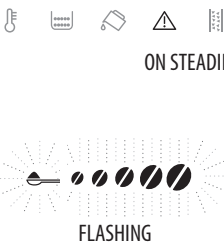

The appliance must not be disposed of with household waste, but taken to an authorised waste separation and recycling centre.

24. EXPLANATION OF LIGHTS

LIGHTS DISPLAYED	POSSIBLE CAUSE	REMEDY
 <p>FLASHING</p>	Insufficient water in the tank (A17)	Fill the tank with water and/or insert it correctly, pushing it as far as it will go until it clicks into place.
 <p>ON STEADILY</p>	The tank (A17) is missing or not correctly in place	Insert the tank correctly, pushing it as far as it will go until it clicks into place.
 <p>FLASHING</p>	The grounds container (A11) is full	Empty the grounds container and drip tray (A15), clean and replace (fig. 16). Important: when removing the drip tray, the grounds container must be emptied, even if it contains few grounds. If this is not done, when you make the next coffees, the grounds container may fill up more than expected and clog the machine.
 <p>ON</p>	After cleaning, the grounds container (A11) has not been replaced	Remove the drip tray (A15) and insert the grounds container.
 <p>ON STEADILY</p>	The coffee beans have run out	Fill the beans container (A3 - fig. 9).
 <p>FLASHING</p>	The pre-ground coffee funnel (A4) is clogged	Empty the funnel with the help of the brush (C5) as described in section "18.8 Cleaning the pre-ground coffee funnel".
 <p>ON STEADILY</p>	The pre-ground coffee function has been selected without placing any pre-ground coffee in the funnel (A4)	Place pre-ground coffee in the funnel (fig. 12) or deselect the "pre-ground" function.
 <p>FLASHING</p>	The pre-ground coffee funnel (A4) is clogged	Empty the funnel with the help of the brush (C5) as described in section "18.8 Cleaning the pre-ground coffee funnel".
 <p>FLASHING</p>	The machine must be descaled	The descaling procedure described in section "19. Descaling" needs to be performed.

 <p>FLASHING</p> <p>FLASHING</p>	<p>The grinding is too fine and the coffee is delivered too slowly or not at all</p> <p>If the water softener filter (C4) is present, an air bubble may have been released inside the circuit, obstructing delivery</p>	<p>Repeat coffee delivery and turn the grinding adjustment dial (A5 - fig. 8) one click clockwise towards "7" while the coffee mill is in operation. If after making at least 2 coffees delivery is still too slow, repeat the correction procedure, turning the grinding adjustment dial another click until delivery is correct (see section "15.1 Adjusting the coffee mill"). If the problem persists, make sure the water tank (A17) is fully inserted, turn the steam/hot water dial (A22) to the I position and deliver a little water until the flow is regular.</p> <p>Deliver a little water by turning the steam/hot water dial (A22) to the I position until the flow is regular.</p>
 <p>FLASHING</p> <p>FLASHING</p>	<p>The pre-ground coffee used is too fine and the coffee is delivered too slowly or not at all</p> <p>If the water softener filter (C4) is present, an air bubble may have been released inside the circuit, obstructing delivery</p>	<p>Repeat coffee delivery using less pre-ground coffee, or a different type. If the problem persists, make sure the water tank (A17) is fully inserted, turn the steam/hot water dial (A22) to the I position and deliver a little water until the flow is regular.</p> <p>Deliver a little water by turning the steam/hot water dial (A22) to the I position until the flow is regular.</p>
 <p>FLASHING</p> <p>ON STEADILY</p>	<p>A LONG coffee with pre-ground coffee has been requested</p>	<p>Put one level measure (C2) of pre-ground coffee into the pre-ground coffee funnel (A4) and press  OK (B15) to continue and complete preparation.</p>
 <p>ON STEADILY</p> <p>FLASHING</p>	<p>Too much coffee has been used</p>	<p>Select a lighter taste by pressing  (B8) or reduce the quantity of pre-ground coffee.</p>

 <p>FLASH. + FLASH.</p>  <p>FLASHING</p>	<p>The water circuit is empty</p>	<p>Turn the steam/hot water dial (A22) to the I position until delivery stops, then bring it back to the 0 position. If the alarm occurs while hot water or steam is being delivered, turn the dial to the 0 position. Turn the steam/hot water dial to the I position until delivery stops, then bring it back to the 0 position. If the problem persists, make sure the water tank (A17) is fully inserted.</p>
 <p>ON STEADILY</p>	<p>The inside of the appliance is very dirty</p>	<p>Clean the inside of the appliance thoroughly, as described in section "18. Cleaning". If the message is still displayed after cleaning, contact Customer Services.</p>
 <p>FLASHING</p>	<p>The infuser (A8) has not been replaced after cleaning</p>	<p>Insert the infuser as described in section "18.9 Cleaning the infuser".</p>
 <p>FLASHING</p>	<p>Indicates the steam/hot water dial (A22) must be turned</p>	<p>Turn the steam/hot water dial.</p>
 <p>FLASHING</p> 	<p>The machine must be descaled</p>	<p>The descaling procedure needs to be performed as soon as possible (see section "19. Descaling").</p>

25. TROUBLESHOOTING

Below is a list of some of the possible malfunctions.

If the problem cannot be resolved as described, contact Customer Services.

PROBLEM	POSSIBLE CAUSE	REMEDY
<p>The coffee is not hot.</p>	<p>The cups were not preheated.</p>	<p>Warm the cups by rinsing them with hot water (Please note: you can use the hot water function).</p>
	<p>The internal circuits of the appliance have cooled down because 2/3 minutes have elapsed since the last coffee was made.</p>	<p>Before making coffee, rinse the internal circuits by pressing the  icon (B15).</p>
	<p>A low coffee temperature is set.</p>	<p>Set a higher coffee temperature in the menu (see section "9. Setting temperature").</p>

The coffee is weak or not creamy enough.	The coffee is ground too coarsely.	Turn the grinding adjustment dial (A5) one click anticlockwise towards 1 while the coffee mill is in operation (fig. 8). Continue one click at a time until coffee delivery is satisfactory. The effect is only visible after delivering 2 coffees (see section "15.1 Adjusting the coffee mill").
	The coffee is unsuitable.	Use coffee beans suitable for espresso machines.
The coffee is delivered too slowly or a drop at a time.	The coffee is ground too finely.	Turn the grinding adjustment dial (A5) one click clockwise towards 7 while the coffee mill is in operation (fig. 8). Continue one click at a time until coffee delivery is satisfactory. The effect is only visible after delivering 2 coffees (see section "15.1 Adjusting the coffee mill").
The appliance will not make coffee	The appliance has detected impurities in its internal circuits, the ☕ light (B1) flashes	Wait for the appliance to be ready for use again and reselect the required beverage. Contact Customer Services if the problem persists.
The infuser (A8) cannot be extracted	The appliance has not been turned off correctly	Turn the appliance off by pressing the ⏻ button (A23) (see section "7. Turning the appliance off").
At the end of descaling, the appliance requests a third rinse	During the two rinse cycles, the water tank has not been filled to the MAX level.	Follow the instructions displayed by the appliance, but first empty the drip tray (A15) to avoid the water overflowing.
The frothed milk has large bubbles	The milk is not cold enough or is not semi-skimmed	You should ideally use skimmed or semi-skimmed milk at refrigerator temperature (about 5°C). If the result is not as you wished, try changing brand of milk.
The milk is not frothed	The cappuccino maker (A22) and steam/hot water connection nozzle (A21) are dirty	Clean as described in section "16.1 Cleaning the cappuccino maker after use".
Steam delivery stops	A safety device stops steam delivery	Wait a few minutes and then enable the steam function again.
The appliance does not come on	The appliance is not plugged into the mains socket	Plug into the mains socket (fig. 1).
	The main switch (A6) is not turned on	Press the main switch (fig. 1).
Coffee does not come out of one or both of the coffee spouts	The coffee spouts (A19) are blocked	Clean as described in section "18.7 Cleaning the coffee spouts".

26. ELECTRICAL REQUIREMENTS

Before using this appliance ensure that the voltage indicated on the product corresponds with the main voltage in your home, if you are in any doubt about your supply contact your local electricity company.

The flexible mains lead is supplied connected to a B.S. 1363 fused plug having a fuse of 13 amp capacity.

Should this plug not fit the socket outlets in your home, it should be cut off and replaced with a suitable plug, following the procedure outlined below.

Note: Such a plug cannot be used for any other appliance and should therefore be properly disposed of and not left where children might find it and plug it into a supply socket - with the obvious consequent danger.

Please note: We recommend the use of good quality plugs and wall sockets that can be switched off when the machine is not in use.

IMPORTANT: The wires in the mains lead fitted to this appliance are coloured in accordance with the following code:

GREEN AND YELLOW
BLUE
BROWN

EARTH
NEUTRAL
LIVE

Green and Yellow to Earth

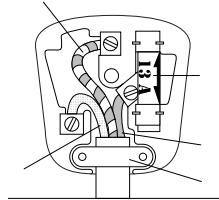

As the colours of the wires in the mains lead of this appliance may not correspond with the coloured markings identifying the terminals in your plug, proceed as follows:

- The wire which is coloured green and yellow must be connected to the terminal in the plug which is marked with the letter E or by the earth symbol  or coloured green or green and yellow.
- The wire which is coloured blue must be connected to the terminal which is marked with the letter N or coloured black.
- The wire which is coloured brown must be connected to the terminal which is marked with the letter L or coloured red.

When wiring the plug, ensure that all strands of wire are securely retained in each terminal. Do not forget to tighten the mains lead clamp on the plug. If your electricity supply point has only two pin socket outlets, or if you are in doubt, consult a qualified electrician.

Should the mains lead ever require replacement, it is essential that this operation be carried out by a qualified electrician and should only be replaced with a flexible cord of the same size.

After replacement of a fuse in the plug, the fuse cover must be refitted. If the fuse cover is lost, the plug must not be used until a replacement cover is obtained. The colour of the correct replacement fuse cover is that of the coloured insert in the base of the fuse recess or elsewhere on the plug. Always state this colour when ordering a replacement fuse cover.

Only 13amp replacement fuses which are asta approved to B.S. 1362 should be fitted.

This appliance conforms to the Norms EN 55014 regarding the suppression of radio interference.

Warning - this appliance must be earthed