

CONTENTS

1. INTRODUCTION	8	17.6 Cleaning the water tank.....	15
1.1 Letters in brackets.....	8	17.7 Cleaning the coffee spouts.....	16
1.2 Troubleshooting and repairs.....	8	17.8 Cleaning the pre-ground coffee funnel.....	16
1.3 Video available on.....	8	17.9 Cleaning the infuser.....	16
2. DESCRIPTION	8	18. DESCALING	16
2.1 Description of the machine.....	8	19. SETTING WATER HARDNESS	17
2.2 Description of the touch screen.....	8	19.1 Measuring water hardness.....	17
3. BEFORE USE	9	19.2 Setting water hardness.....	17
3.1 Checking the machine.....	9	20. WATER SOFTENER FILTER	18
3.2 Installing the machine.....	9	20.1 Installing the filter.....	18
3.3 Connecting the machine.....	9	20.2 Replacing the filter.....	18
3.4 Setting up the machine.....	9	21. TECHNICAL DATA	18
4. TURNING THE MACHINE ON	9	22. EXPLANATION OF LIGHTS	19
5. TURNING THE MACHINE OFF	10	23. TROUBLESHOOTING	21
6. SETTING WATER HARDNESS	10		
7. SETTING TEMPERATURE	10		
8. AUTO-OFF	10		
9. ENERGY SAVING	11		
10. BEEP	11		
11. DEFAULT VALUES (RESET)	11		
12. RINSING	11		
13. MAKING COFFEE	11		
13.1 Adjusting the coffee grinder.....	11		
13.2 Tips for a hotter coffee.....	12		
13.3 Making coffee using coffee beans.....	12		
13.4 Temporarily varying the coffee aroma.....	12		
13.5 Making coffee using pre-ground coffee.....	13		
13.6 Customising aroma and quantity.....	13		
14. MAKING TRUEBREW OVER ICE™	13		
14.1 Programming TrueBrew Over Ice™ length...13			
15. MAKING CAPPUCCINO AND HOT MILK (NOT FROTHED)	14		
15.1 Making hot milk (not frothed).....	14		
15.2 Cleaning the frother after use.....	14		
16. DELIVERING HOT WATER	14		
17. CLEANING	15		
17.1 Cleaning the machine.....	15		
17.2 Cleaning the machine's internal circuit.....	15		
17.3 Cleaning the coffee grounds container.....	15		
17.4 Cleaning the drip tray and condensate tray.....	15		
17.5 Cleaning the inside of the coffee machine.....	15		

IMPORTANT SAFEGUARDS

When using electrical machines, basic safety precautions should always be followed, including the following.

- Read all instructions carefully.
- Make sure the voltage of your electrical system corresponds to the voltage shown on the bottom of the machine.
- Do not touch hot surfaces. Use handles or knobs.
- To protect against fire, electrical shock and personal injury, do not immerse cord, plug or machine in water or other liquid.
- Keep the machine out of the reach of children and do not leave machine unattended while in operation.
- Unplug from the outlet when not in use and before cleaning.
- Do not operate with a damaged cord or plug, or after the machine malfunctions, or has been damaged in any manner. Return the machine to the nearest authorized service facility for examination, repair or adjustment.
- The use of accessory attachments not recommended by the manufacturer may result in fire, electrical shock, or personal injury.
- Do not use outdoors.
- Make sure the power cord does not hang over the edge of the table or counter-top to avoid getting accidentally caught or entangled.
- Do not place the machine or its electrical parts on or near electric stoves, cooking surfaces, or gas burners.
- Plug cord into the wall outlet. To disconnect, first turn machine "off", then remove plug from wall outlet.
- Do not use the machine for other than the intended use. This machine is to be utilized for domestic use only. The manufacturer declines all responsibility for any damage caused by improper, incorrect, or irresponsible use.

WARNING: To reduce the risk of fire or electric shock, do not remove the cover or the exterior of the unit. Don't attempt to repair or modify the machine, doing so will void the warranty. Repair should be done by authorized service personnel only!

SAVE THESE INSTRUCTIONS

THIS MACHINE IS FOR HOUSEHOLD USE ONLY

SHORT CORD INSTRUCTIONS

- A short power cord is provided to reduce risks resulting from becoming entangled in or tripping over a longer cord.
- Longer, detachable power supply cords or extension cords are available and may be used if care is exercised in their use.
- If an extension cord is used, the marked electrical rating should be at least as great as the electrical rating of the machine. If the machine is provided with 3- wire, grounding type cord, the extension should be a GROUNDING TYPE 3 - WIRE CORD. The longer cord should be arranged so that it will not drape over the counter-top or table top where it can be pulled on by children or tripped over.
- Your product is equipped with a polarized alternating current line plug (a plug having one blade wider than the other). This plug will fit into the power outlet only one way. This is a safety feature. If you are unable to insert the plug fully into the outlet, try reversing the plug. If the plug should still fail to fit, contact your electrician to replace your obsolete outlet. Do not defeat the safety purpose of the polarized plug.

1. INTRODUCTION

Thank you for choosing this automatic coffee machine with frother.

We hope you enjoy using your new machine.

Take a few minutes to read these instructions.

This will avoid all risks and damage to the machine.

Symbols used in these instructions

Important warnings are identified by these symbols.

It is vitally important to observe these warnings.



Danger!

Failure to observe the warning could result in life threatening injury from electric shock.



Important!

Failure to observe the warning could result in injury or damage to the machine.



Danger of burns!

Failure to observe the warning could result in scalds.



Please note:

This symbol identifies important advice or information for the user.

1.1 Letters in brackets

The letters in brackets refer to the legend in the Description of the Machine on page 2 and 3.

1.2 Troubleshooting and repairs

In the event of problems, first try and resolve them following the information given in the section "22. Explanation of lights" and "23. Troubleshooting".

If this does not resolve the problem or you require further information, you should consult Customer Experience by calling the number given on the annexed "Customer Experience" sheet. If your country is not among those listed on the sheet, call the number given in the warranty.

If repairs are required, contact De'Longhi Customer Experience only.

Contact details are given in the guarantee certificate provided with the machine.

2. DESCRIPTION

2.1 Description of the machine











(page 3 - A)





- A1. Beans container lid
- A2. Pre-ground coffee funnel lid
- A3. Beans container
- A4. Pre-ground coffee funnel
- A5. Grinding adjustment dial
- A6. Main switch
- A7. Infuser door
- A8. Infuser
- A9. Power cord
- A10. Condensate tray
- A11. Coffee grounds container
- A12. Cup tray
- A13. Drip tray water level indicator
- A14. Drip tray grille
- A15. Drip tray
- A16. Water tank lid
- A17. Water tank
- A18. Water softener filter housing
- A19. Coffee spouts (adjustable height)
- A20. Frother (removable)
- A21. Frother selection ring
- A22. Hot water and steam connection nozzle (removable)
- A23. Steam/hot water dial
- A24.  button: to turn the machine on and off (standby)

2.2 Description of the touch screen

(page 2 - B)

A number of icons on the touch screen have a double function. This is indicated in brackets in the description.

- B1.  light flashing: the machine is heating up
- B2.  light:
 - on steadily: put the grounds container (A11) back in place
 - flashing: the grounds container needs to be emptied
- B3.  light:
 - on steadily: insert the water tank (A17)
 - flashing: insufficient water in the tank
- B4.  light: general alarm (see section "22. Explanation of lights")
- B5.  light:
 - on steadily: descaling programme underway
 - flashing: the machine needs descaling
- B6.  : pre-ground function
- B7.  : coffee strength
- B8.  : strength selection
- B9. **2x** : to deliver 2 cups of "espresso" or "espresso lungo"
- B10.  : "Espresso"
- B11.  : "Espresso Lungo"

- B12.  TrueBrew Over Ice (TM) Coffee
- B13. : "Long"
- B14.  **ESC:**
- on steadily: press to turn the steam function on (*when in the settings menu: press to exit the current programming*)
 - flashing: the steam/hot water dial (A23) must be turned on or off
- B15.  **OK:** to perform a rinse cycle.
(*When in the settings menu: press to confirm the current programming*)

Description of the accessories

(page 2 - C)

- C1. "Total hardness test" Indicator paper
- C2. Pre-ground coffee measuring scoop
- C3. Descaler
- C4. Water softener filter (certain models only)
- C5. Cleaning brush

3. BEFORE USE

3.1 Checking the machine

After removing the packaging, make sure the product is complete and undamaged and that all accessories (C) are present. Do not use the machine if it is visibly damaged. Contact De'Longhi Customer Services.

3.2 Installing the machine

Important!

When you install the machine, you should respect the following safety warnings:

- The machine gives off heat. After positioning the machine on the worktop, leave a space of at least 1.18 in / 3 cm between the surfaces of the machine and the side and rear walls and at least 5.9 in/15 cm above the coffee maker.
- Water penetrating the coffee machine could cause damage.
Do not place the machine near taps or sinks.
- The machine could be damaged if the water it contains freezes.
Do not install the machine in a room where the temperature could drop below freezing point.
- Arrange the power cord (A9) in such a way that it cannot be damaged by sharp edges or contact with hot surfaces (e.g. electric hot plates).

3.3 Connecting the machine

Important!





Check that the main power supply voltage corresponds to that indicated on the rating plate on the bottom of the machine. Connect the machine to an efficiently earthed and correctly installed socket with a minimum current rating of 10A only. If the power socket does not match the plug on the machine, have the socket replaced with a suitable type by a qualified professional.

3.4 Setting up the machine

Please note:

- Coffee has been used to factory test the machine and it is therefore completely normal for there to be traces of coffee in the grinder. The machine is, however, guaranteed to be new.
- You should customise water hardness as soon as possible following the instructions in section "19. Setting water hardness".

Proceed as described:

1. Plug the machine into the mains socket and press the main switch (A6) on the back of the machine (fig. 1).
2. The  light (B3) flashes on the touch screen (B): Remove the water tank (A17 - fig. 2), fill to the MAX line with fresh water (fig. 3A) then put back in the machine (fig. 3B).
3. The  icon (B14 - fig. 5) flashes on the touch screen.
4. Place a container with a minimum capacity of 3.38 floz/100 ml under the frother (A20) (fig. 4).
5. Turn the steam/hot water dial (A23) to the "I" position (fig. 6) and press the  **OK** icon (B15). Water is delivered from the frother.
6. When delivery stops automatically, the  icon flashes on the touch screen to indicate that the steam dial must be turned back to the "O" position.

The machine goes off.

To use it, press the  button (A24 - fig. 7).

Please note:

- The first time you use the machine, you need to make 4-5 cups of coffee before it starts to give satisfactory results.
- To enjoy your coffee even more and improve the performance of your machine, we recommend installing a water softener filter (C4) as described in section "20. Water softener filter". If your model is not provided with a filter, you can request one from De'Longhi Customer Services.

4. TURNING THE MACHINE ON



Please note:

Before turning the machine on, make sure the main switch (A6) on the back of the machine is pressed (fig. 1).

Each time the machine is turned on, it performs an automatic preheat and rinse cycle which cannot be interrupted. The machine is ready for use only after completion of this cycle.



Danger of burns!

During rinsing, a little hot water comes out of the coffee spouts (A19) and is collected in the drip tray (A15) underneath. Avoid contact with splashes of water.

- To turn the machine on, press the button (A24) (fig. 7). The light (B1) flashes on the touch screen (B) to indicate the machine is heating up.

While heating up, the machine performs a rinse cycle. As well as heating the boiler, this also heats the internal circuits by circulating hot water.

The machine is at temperature when the light on the touch screen goes off and the coffee icons come on.

5. TURNING THE MACHINE OFF

Whenever the coffee machine is turned off after being used to make coffee, it performs an automatic rinse cycle.



Danger of burns!

During rinsing, a little hot water flows from the coffee spouts (A19). Avoid contact with splashes of water.

- To turn the machine off, press the button (A24 - fig. 7);
- the light (B1) flashes on the touch screen and (if provided for) the machine performs a rinse cycle then goes off (standby).



Please note:

If you will not be using the machine for some time, unplug from the mains socket:

- first turn the machine off by pressing the button;
- release the main switch (A6) (fig. 1).



Important!

Never press the main switch while the machine is on.

6. SETTING WATER HARDNESS

For instructions on setting water hardness, see section "19. Setting water hardness".

7. SETTING TEMPERATURE

If you want to modify the temperature of the water used to make the coffee (low, medium, high, maximum), proceed as follows:

- With the machine off (standby), but the main switch pressed on (A6) (fig. 1);
- Press and hold the **2x** icon (B9) until the lights on the touch screen (B) come on;
- Press the icon (B10);
- Press the icon again to select the required temperature:

	low
	medium
	high
	maximum

- Press the **OK** icon (B15) to confirm (or **ESC** (B14) to exit without making the change). The lights go off.

The machine returns to "standby" and the temperature is now programmed.

8. AUTO-OFF

The time can be changed so that the machine switches off after being idle for 15 or 30 minutes, or after 1, 2 or 3 hours.

To change the Auto-off setting, proceed as follows:

- With the machine off (standby), but the main switch pressed on (A6) (fig. 1);
- Press and hold the **2x** icon (B9) until the icons on the touch screen (B) come on;
- Press the icon (B11);
- Select the required time interval by pressing the icon again:

	15 min.
	30 min.
	1 hour

	2 hours
	3 hours

- Press the **OK** icon (B15) to confirm (or **ESC** (B14) to exit without making the change). The lights go off. The auto-off time is now programmed.

9. ENERGY SAVING

Use this function to enable or disable energy saving. This mode is active by default, reducing energy consumption while the machine is on in compliance with current European regulations. To change the setting, proceed as follows:

- With the machine off (standby), but the main switch pressed (A6) (fig. 1);
- Press and hold the **2x** icon (B9) until the icons on the touch screen (B) come on.
- Press the icon (B13);
- Press the icon again to enable/disable the function:
 - function enabled
 - function disabled
- Press the **OK** icon (B15) to confirm (or **ESC** (B14) to exit without making the change). The lights go off. The energy saving setting is now programmed.

Please note:

- When in energy saving mode, a few seconds may elapse before the first coffee is delivered as the machine must heat up again.

10. BEEP

This function enables or disables the beep. Proceed as follows:

- With the machine off (standby), but the main switch pressed (fig. 1);
- Press and hold the **2x** icon (B9) until the lights on the touch screen (B) come on.
- Press the **2x** icon to enable/disable the function:
 - function enabled
 - function disabled
- Press the **OK** icon (B15) to confirm (or **ESC** (B14) to exit without making the change). The lights go off. The beep is now programmed.

11. DEFAULT VALUES (RESET)

This function resets all settings (temperature, auto-off, water hardness, energy saving and all quantity settings are reset to the default values).

- With the machine off (standby), but the main switch pressed (fig. 1);
- Press and hold the **2x** icon (B9) until the lights on the touch screen (B) come on.
- Press the icon (B12). The beans (B7) on the touch screen flash;
- Press the **OK** icon (B15) to reset the default values (or **ESC** (B14) to exit without making the change). The lights go off.

The settings and quantities of the beverages have been reset to the default values.

12. RINSING

Use this function to deliver hot water from the coffee spouts (A19) to clean and heat the machine's internal circuit. Place a container with a minimum capacity of 3.38 floz/100ml under the coffee and hot water spouts.

Important! Danger of burns.

Do not leave the machine unattended while hot water is being delivered.

- To activate the function, press **OK** (B15);
- After a few seconds, hot water is delivered from the coffee spouts, cleaning and heating the machine's internal circuit.
- To interrupt the function manually, press **OK** again.

Please note:

- If the machine is not used for more than 3-4 days, when switched on again, we strongly recommend performing 2/3 rinses before use;
- After cleaning it is normal to have water collected in the coffee ground container (A11).

13. MAKING COFFEE

13.1 Adjusting the coffee grinder

The coffee grinder is set by default to prepare coffee correctly and should not require regulating initially. However, if after making the first few coffees you find that the coffee is either too weak and not creamy enough or delivery is too slow (a drop at a time), this can be corrected by calibrating the coffee grinding using the adjusting dial (A5) (fig. 8).

Please note:

The grinding adjustment dial must only be turned when the coffee grinder is in operation.



If the coffee is delivered too slowly or not at all, turn one click clockwise towards 7. For fuller bodied creamier coffee, turn one click anticlockwise towards 1 (do not turn more than one click at a time otherwise the coffee could be delivered a drop

at a time).

These adjustments will only be evident after at least 2 cups of coffee have been delivered. If this adjustment does not obtain the desired result, turn the dial another click.

13.2 Tips for a hotter coffee

For hotter coffee, you should:

- perform a rinse cycle by pressing OK (B15);
- warm the cups with hot water using the hot water function (see section "16. Delivering hot water");
- increase the coffee temperature (see section "7. Setting temperature").

13.3 Making coffee using coffee beans



Important!

Do not use green, caramelised, oily, flavored or candied coffee beans as they could stick to the coffee grinder and make it unusable.

1. Fill the container (A3) (fig. 9) with coffee beans;
2. Place under the coffee spouts (A19):
 - 1 cup, if you want to make 1 coffee (fig. 10);
 - 2 cups if you want 2 coffees.
3. Lower the spouts as near as possible to the cup. This makes a creamier coffee (fig. 11);
4. Then select the desired coffee:

Recipe	Quantity	Program-mable quantity	Default strenght
Espresso (B10)	≈ 1.35 floz/40 ml	from ≈0.68 fl oz / 20 to ≈ 2.70 fl oz / 80ml	
Espresso Lungo (B11)	≈ 4.06 floz / 120 ml	from ≈ 2.70 fl oz / 80 to ≈6.09 floz / 180ml	
Long (B13)	≈ 5.41 floz / 160 ml	from ≈3.89 floz / 115 to ≈8.45 floz/250ml	

2x (B9) + Espresso (B10)	≈ 1.35 floz / 40 ml x 2 cups	--	
2x (B9) + Espresso Lungo (B11)	≈ 4.06 floz / 120 ml x 2 cups	--	

5. Preparation begins. When delivery finishes, the light corresponding to the selected icon flashes on the touch screen (B) indicating the possibility to increase the quantity in the cup, within 3 seconds, by pressing the icon.

Please note:

- **To make 2 cups of "espresso" or "espresso lungo" at the same time:**

- Press the "2X" icon (B9). The icons corresponding to the beverages available for selection light up and the "2X" icon flashes. Press or : Preparation begins.

Alternatively, proceed as follows:

- Press or : preparation begins and the "2X" icon flashes for a few seconds. Press the "2X" icon while it is flashing.

- While the machine is making coffee, delivery can be interrupted at any moment by pressing the coffee icon.

Once the coffee has been made, the machine is ready to make the next beverage.



Please note:

- Lights may be displayed on the touch screen (B) during use. Their meaning is given in section "22. Explanation of lights".
- For hotter coffee, see section "13.2 Tips for a hotter coffee".
- If the coffee is delivered a drop at a time, too weak and not creamy enough or too cold, read the tips in section "23. Troubleshooting".
- To customise the beverages according to personal taste, see section "13.6 Customising strength and quantity".

13.4 Temporarily varying the coffee strength

To temporarily vary the coffee strength, press (B8):

	EXTRA LIGHT
	LIGHT
	MEDIUM

	STRONG
	X-STRONG
	(see "13.5 Making coffee using pre-ground coffee")

i Please note:

- The variation in strength is not saved and the next time a beverage is delivered automatically, the machine selects the default value.
- If a few seconds elapse between temporary customising of the strength and delivery of the beverage, the aroma returns to the default value.

13.5 Making coffee using pre-ground coffee



! Important!



- Never add pre-ground coffee when the machine is off or it could spread through the inside of the machine and dirty it. This could damage the machine.
- Never use more than 1 level measure (C2) or it could dirty the inside of the coffee machine or block the funnel (A4).



i Please note:

If you use pre-ground coffee, you can only make one cup of coffee at a time.



1. Press the  (B8) repeatedly until the  light (B6) comes on.
2. Make sure the funnel is not blocked, then add one level measure of pre-ground coffee (fig. 12).
3. Place a cup under the coffee spouts (A19) (fig. 10).
4. Then select the desired coffee:

Recipe	Quantity
 Espresso (B10)	≈ 1.35 fl oz / 40 ml
 Espresso Lungo (B11)	≈ 4.06 fl oz / 120 ml
 Long (B13)	≈ 5.41 fl oz / 160 ml

5. Preparation begins. When delivery finishes, the light corresponding to the selected icon flashes on the touch screen

(B) indicating the possibility to increase the quantity in the cup, within 3 seconds, by pressing the icon.

! Important! Making LONG coffee  using pre-ground coffee:

Halfway through preparation, the  light flashes. Add one level measure of pre-ground coffee and press  OK (B15).

i Please note:

If "Energy Saving" mode is active, you may have to wait a few seconds before the first coffee is delivered.

13.6 Customising strength and quantity



The machine is set by default to make coffee with a standard strength and quantity (see table in section "13.3 Making coffee using coffee beans").

To customise the coffee, proceed as follows:

1. Place a sufficiently large cup or glass under the coffee spouts (A19);
2. Press  (B8) to select the required aroma (see section "13.4 Temporarily varying the coffee strength");
3. Press and hold the icon corresponding to the coffee to be customised. The icon flashes and all the alarm lights flash 4 times;
4. Release the icon. The icon flashes and the machine starts delivering coffee;
5. As soon as the coffee in the cup reaches the required level, press the coffee icon again.

The strength and quantity of coffee in the cup has now been programmed.



14. MAKING TRUEBREW OVER ICE™



1. Place 3 ice cubes in a large glass, press the strength selector  (B8) to choose a strength (strong or extra strong recommended), and place the glass under the brewing unit;
4. Then, press the  TrueBrew Over Ice™ button to brew the coffee (fig. 14);
5. Add 3 more ice cubes to the glass/coffee plus any syrup, sweetener or milk desired and enjoy.

! Important!

Always use glasses resistant to thermal shock.

14.1 Programming TrueBrew Over Ice™ length

1. Press the  TrueBrew Over Ice™ button (B12):  (B8) flashes indicating that it is necessary to select the strength;
2. Press  (B8) to select the required strength (see section "13.4 Temporarily varying the coffee strength");

- Press and hold the  TrueBrew Over Ice™ button (B12) until the button and the lights on the touch screen (B) flash;
- When the desired quantity is reached, press again the  TrueBrew Over Ice™ button to save new quantity.

Recipe	Quantity	Programmable quantity
 TrueBrew Over Ice™ coffee (B12)	≈ 3.38 fl oz / 100 ml	from ≈ 1.35 fl oz / 40 ml to ≈ 8.11 fl oz / 240ml

15. MAKING CAPPUCCINO AND HOT MILK (NOT FROTHED)

Danger of burns!

During preparation steam is delivered. Take care to avoid burns.

- When preparing cappuccino, make the coffee in a large cup.
- Fill a container (preferably one with a handle to avoid burning) with about 100 grams/3.53 oz. of milk for each cappuccino. In choosing the size of the container, bear in mind that the milk doubles or triples in volume.





Please note:

For a richer denser froth, use milk at refrigerator temperature (about 5°C). To avoid milk with poor froth or large bubbles, always clean the frother (A20) as described in section “15.2 Cleaning the frother after use”.

- Make sure the frother selection ring (A21) is positioned downwards in the “CAPPUCCINO” position;
- The frother can be turned slightly outwards to allow containers of any size to be used.

Important!

Never use force to turn the frother (fig. 15). It could break!

- Immerse the frother in the milk container. Never immerse the black ring;
- Press the  icon (B14). The  light (B1) flashes to indicate the machine is heating up.
- When the machine is at temperature, the  light goes off and the  icon flashes.
- Turn the steam/hot water dial  (A23) to the **I** position. After a few seconds, steam is delivered from the frother, giving the milk a creamy frothy appearance and making it more voluminous. For a thicker froth, rotate the container with slow movements in an upward direction.

- When you have obtained the desired froth, stop steam delivery by turning the dial to the “**0**” position.

Danger of burns!

Interrupt steam delivery before removing the container with the frothed milk to avoid burns caused by splashes of boiling milk.

- Add the frothed milk to the coffee prepared previously. The cappuccino is ready. Sweeten to taste and, if desired, sprinkle the froth with a little cocoa powder.

Please note:

If “Energy saving” is active, you may have to wait a few seconds before steam is delivered.

15.1 Making hot milk (not frothed)

To make hot milk without froth, proceed as described in the above section, but with the frother selection ring (A21) positioned upwards in the “HOT MILK” position.

15.2 Cleaning the frother after use

Clean the frother (A20) each time you use it to avoid the build-up of milk residues or blockages.

Danger of burns!



When cleaning the frother, a little hot water is delivered. Avoid contact with splashes of water.

- Deliver a little water by turning the steam/hot water dial  (A23) to the **I** position. Then stop delivery by turning the dial back to the **0** position.
- Wait a few minutes for the frother to cool down, then rotate the frother anticlockwise and extract downwards (fig. 16).
- Move the selection ring (A21) upwards (fig. 17).
- Remove the connection nozzle downwards (A22 - fig. 18).
- Make sure the two holes shown by the arrow in fig. 19 are not blocked. If necessary, clean with a pin.
- Reinsert the connection nozzle and replace the frother on the nozzle, pushing it upwards and turning it until it is attached (fig. 20).

16. DELIVERING HOT WATER

Important! Danger of burns.

Never leave the machine unattended while delivering hot water. The spout of the frother (A20) becomes hot during delivery.

- Place a container under the frother (A20) (as close as possible to avoid splashes).
- Turn the steam/hot water dial  (A23) to the **I** position.
- To stop hot water delivery manually, turn the steam/hot water dial  to the **0** position.

Please note:

If “Energy Saving” is active, you may have to wait a few seconds before hot water and steam are delivered.

17. CLEANING

17.1 Cleaning the machine

The following parts of the machine must be cleaned regularly:

- the internal circuit;
- coffee grounds container (A11);
- drip tray (A15) and condensate tray (A10);
- water tank (A17);
- coffee spouts (A19);
- frother ("15.2 Cleaning the frother after use");
- pre-ground coffee funnel (A4);
- infuser (A8), accessible after opening the infuser door (A7);
- touch screen (B).



Important!

- Do not use solvents, abrasive detergents or alcohol to clean the coffee machine. With De'Longhi superautomatic coffee machines, you don't need to use chemical products to clean the machine.
- None of the components of the machine can be washed in a dishwasher with the exception of the drip tray grille (A14).
- Do not use metal objects to remove encrustations or coffee deposits as they could scratch metal or plastic surfaces.

17.2 Cleaning the machine's internal circuit

If the machine is not used for more than 3/4 days, before using it again, we strongly recommend switching it on and:

- performing 2/3 rinse cycles by pressing  (B15);
- delivering hot water for a few seconds (section "16. Delivering hot water").



Please note:

After cleaning, it is normal to find water in the coffee ground container (A11).

17.3 Cleaning the coffee grounds container

When the  light (B2) flashes, the coffee grounds container (A11) must be emptied and cleaned. The machine cannot be used to make coffee until you have cleaned the grounds container. Even if not full, the empty grounds container message appears on the display 72 hours after the first coffee has been prepared. For the 72 hours to be calculated correctly, the machine must never be turned off with the main switch (A6).



Important! Danger of burns

If you make a number of cappuccinos one after the other, the metal cup tray (A12) becomes hot. Wait for it to cool down before touching it and handle it from the front only.

To clean (with the machine on):

- Remove the drip tray (A15) (fig. 21), empty and clean.
- Empty the grounds container (A11) and clean thoroughly to remove all residues left on the bottom.
- Check the condensate tray (A10) (red) and empty if necessary.

17.4 Cleaning the drip tray and condensate tray



Important!

The drip tray (A15) is fitted with a level indicator (A13) (red) showing the level of water it contains (fig. 22). Before the indicator protrudes from the cup tray (A12), the drip tray must be emptied and cleaned otherwise the water may overflow the edge and damage the machine, the surface it rests on or the surrounding area.

To remove the drip tray:

1. Remove the drip tray and the coffee grounds container (A11) (fig. 21);
2. Remove the cup tray (A12) and drip tray grille (A14), then empty the drip tray and grounds container and wash all components;
3. Check the red condensate tray (A10) and empty if necessary;
4. Replace the drip tray complete with grille and grounds container.



Important!

When removing the drip tray, the grounds container must be emptied, even if it contains few grounds.

If this is not done, when you make the next coffees, the grounds container may fill up more than expected and clog the machine.

17.5 Cleaning the inside of the coffee machine



Danger of electric shock!

Before cleaning internal parts, the machine must be turned off (see section "5. Turning the machine off") and unplugged from the mains power supply. Never immerse the coffee machine in water.

1. Check regularly (about once a month) that the inside of the machine (accessible after removing the drip tray (A15)) is not dirty. If necessary, remove coffee deposits with the brush (C5) and a sponge;
2. Remove all the residues with a vacuum cleaner (fig. 23).

17.6 Cleaning the water tank

1. Clean the water tank (A17) regularly (about once a month) and whenever you replace the water softener filter (C4)

- (if provided) with a damp cloth and a little mild washing detergent;
- Remove the filter (C4) (if present) and rinse with running water;
 - Replace the filter (if provided), fill the tank with fresh water and replace the tank;
 - (Models with water softener filter only) Deliver about 3.38 floz/100ml of water.

17.7 Cleaning the coffee spouts

- Clean the coffee spouts (A19) regularly with a sponge or cloth (fig. 24A);
- Check that the holes in the coffee spouts are not blocked. If necessary, remove coffee deposits with a toothpick (fig. 24B).

17.8 Cleaning the pre-ground coffee funnel

Check regularly (about once a month) that the pre-ground coffee funnel (A4) is not blocked. If necessary, remove coffee deposits with the brush (C5).

17.9 Cleaning the infuser

The infuser (A8) must be cleaned at least once a month.

Important!

The infuser may not be extracted when the machine is on.

- Make sure the machine is correctly turned off (see section "5. Turning the machine off");
- Remove the water tank (A17);
- Open the infuser door (A7) (fig. 25) on the right side of the machine;
- Press the two coloured release buttons inwards and at the same time pull the infuser outwards (fig. 26);
- Soak the infuser in water for about 5 minutes, then rinse under the tap;

Important!

RINSE WITH WATER ONLY

NO WASHING DETERGENT - NOT DISHWASHER SAFE

Clean the infuser without using washing detergent as it could be damaged.

- Use the brush (C5) to remove any coffee residues left in the infuser housing, visible through the infuser door;
- After cleaning, replace the infuser by sliding it onto the internal support, then push the PUSH symbol fully in until it clicks into place;



Please note:

If the infuser is difficult to insert, before insertion, adapt it to the right size by pressing the two levers (fig. 27).



- Once inserted, make sure the two coloured buttons have snapped out;

- Close the infuser door;
- Put the water tank back.

18. DESCALING

Descal the machine when the  light (B5) on the touch screen (B) flashes and only the  **OK** (B15) and  **ESC** icons (B14) remain on.





To descale immediately, press  **OK** and follow the instructions from point 4.

To descale the machine later, press  **ESC**. The  light flashes on the touch screen to remind you that the machine needs descaling.

Important!



- Before use, read the instructions and the labelling on the descaler pack.
- You should use De'Longhi descaler only. Using unsuitable descaler and/or performing descaling incorrectly may result in faults not covered by the manufacturer's guarantee.

To descale the machine, proceed as follows:

- Turn the machine off (standby) by pressing the  button (A24 - fig. 7) (see section "5. Turning the machine off");
- Empty the drip tray (A15) and grounds container (A11) and put both back in the machine;
- Press and hold the  icon (B8) until the  light (B5) and the  **ESC** and  **OK** icons light up;
- Empty the water tank (A17) completely and remove the water softener filter (C4), if present;
- Pour the descaler (C3) into the tank up to level A (corresponding to a 3.38 floz / 100ml pack) marked on the inner surface of the tank, then add a litre of water up to level B (fig. 28) and put the water tank back in the machine;
- Place a container with a minimum capacity of 1.8 litres under the frother (A20) and coffee spouts (A19) (fig. 29);









Important! Danger of burns

Hot water containing acid flows from the frother and coffee spouts. Take care to avoid contact with splashes of this solution.

- Press the  **OK** icon to confirm that you have added the descaler solution. The descaling procedure begins;
- After a few minutes, the  **ESC** icon (B14) flashes to indicate the steam/hot water dial  must be turned to the **I** position;
- When the dial has been turned to the **I** position, the descale programme starts and the descaler liquid comes out of the frother. A series of rinses and pauses are performed

automatically to remove all the scale residues inside the coffee machine;

After about 35 minutes, the machine interrupts descaling and the  light (B3) flashes.

10. The machine is now ready for rinsing through with clean water. Empty the container used to collect the descaler solution. Extract the water tank, empty, rinse under running water, fill with fresh water up to the MAX level and put back in the machine;
11. Place the container used to collect the descaler solution empty under the coffee spouts and frother (fig. 29);
12. Press the  **OK** icon:  **ESC** flashes to indicate the steam/hot water dial  must be turned to the **0** position;
13. Turn the steam/hot water dial  to the 0 position to start rinsing. Hot water comes out of the coffee spouts;
14. After a preset time,  **ESC** flashes. Turn the dial to the **I** position. Delivery continues from the frother. When the water in the tank has run out, the  light (B3) comes on;
15. The machine is now ready for a second rinse with clean water. Empty the container used to collect the rinse water. Extract the water tank, empty, rinse under running water, fill with fresh water up to the MAX level, replace the water softener filter (if previously removed) and put back in the machine;
16. Place the container used to collect the rinsing water empty under the frother;
17. Press the  **OK** icon. The machine begins rinsing again from the frother only;
18. When the water in the tank has run out, the  light flashes;
19. Empty the container used to collect the rinse water, remove the water tank and fill with fresh water up to the MAX level, then put back in the machine. The  **ESC** icon flashes;
20. Turn the dial to the **0** position;
21. Empty and replace the drip tray (A15) and grounds container (A11).

Descaling is complete.

 **Please note:**

- If the descaling cycle is not completed correctly (e.g. no electricity) we recommend repeating the cycle;
- After descaling, it is normal for the grounds container (A11) to contain water;

- If the water tank has not been filled to the MAX level, at the end of descaling, the machine requests a third rinse to guarantee that the descaler solution has been completely eliminated from the machine's internal circuits.









19. SETTING WATER HARDNESS

The  light (B5) comes on after a period of time established according to water hardness.





The machine is set by default for a hardness level of 4. The machine can also be programmed according to the hardness of the mains water in the various regions so that the machine needs to be descaled less often.

19.1 Measuring water hardness

1. Remove the "TOTAL HARDNESS TEST" indicator paper (C1) from its pack (attached to the English instructions);
2. Immerse the paper completely in a glass of water for one second;
3. Remove the paper from the water and shake lightly. After about a minute, 1, 2, 3, or 4 red squares form, depending on the hardness of the water. Each square corresponds to 1 level;

Indicator paper	Water hardness	Corresponding setting
	low	
	medium	
	high	
	maximum	

19.2 Setting water hardness

1. With the machine off (standby), but the main switch (A6) pressed (fig. 1);
2. Press and hold the **2x** icon (B9) until the icons on the touch screen (B) come on;
3. Press the  icon (B8);
4. Select the water hardness level by pressing the  icon again :
5. Press the  **OK** icon (B15) to confirm (or  **ESC** (B14) to exit without making the change). The lights go off. The machine is now reprogrammed with the new water hardness setting.

20. WATER SOFTENER FILTER

Certain models are fitted with a water softener filter (C4). If this is not the case with your model, you are recommended to purchase one from De'Longhi Customer Services.

To use the filter correctly, follow the instructions below.

20.1 Installing the filter



1. Remove the filter (C4) from the packaging. The date indicator disk varies according to the filter provided (fig.30);
2. Turn the date disk to display the next 2 months of use.

Please note

The filter lasts about two months if the machine is used normally. If the coffee machine is left unused with the filter installed, it will last a maximum of 3 weeks.

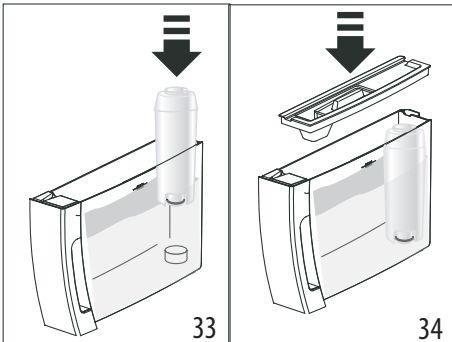
3. To activate the filter, run tap water through the hole in the filter as shown in fig. 31 until water comes out of the openings at the side for more than a minute;
4. Extract the tank (A17) from the machine and fill with water;
5. Insert the filter in the water tank and immerse it completely for about ten seconds, sloping it and pressing it lightly to enable the air bubbles to escape (fig. 32).
6. Insert the filter in the filter housing (A18) and press as far as it will go (fig.33);



7. Close the tank with the lid (A16 - fig. 34), then replace the tank in the machine;
8. Position a container with a minimum capacity of 16.90 fl oz / 500ml under the frother (A20).
9. Deliver hot water by turning the steam/hot water dial  (A23) to the **I** position.
10.  Deliver at least 16.90 fl oz / 500 ml of hot water, then turn the steam/hot water dial  to the **0** position.

The filter is now active and you can use the coffee machine.

20.2 Replacing the filter

After two months (see date indicator) or when the machine has not been used for 3 weeks, you should replace the filter:









1. Extract the tank (A17) and exhausted filter (C4);
2. Take the new filter out of its packet and proceed as described in points 2 to 10 in the previous section.



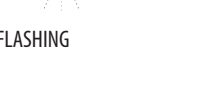



The new filter is now active and you can use the coffee machine.



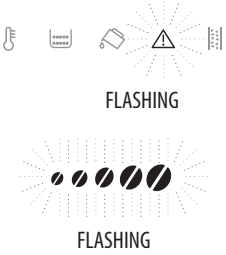
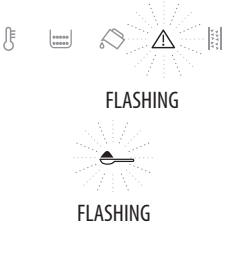

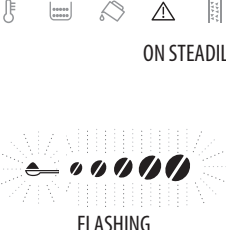

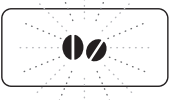

21. TECHNICAL DATA

Voltage:	120 V~ 60 Hz
Absorbed power:	1250 W
Pressure:	1.5MPa (15 bars)
Max. water tank capacity:	60.86 fl oz (1.8 L)
Size LxDxH:	9.45x17.32 x 14.17in. (240x440x360 mm)
Cord length:	45.27 in (1150 mm)
Weight:	20 lb (9.2 kg)
Max. beans container capacity:	10.58 oz (300 g)

22. EXPLANATION OF LIGHTS

LIGHTS DISPLAYED	POSSIBLE CAUSE	REMEDY
 <p>FLASHING</p>	Insufficient water in the tank (A17)	Fill the tank with water and/or insert it correctly, pushing it as far as it will go until it clicks into place.
 <p>ON STEADILY</p>	The tank (A17) is missing or not correctly in place	Insert the tank correctly, pushing it as far as it will go until it clicks into place.
 <p>FLASHING</p>	The grounds container (A11) is full	Empty the grounds container and drip tray (A15), clean and replace. Important: when removing the drip tray, the grounds container must be emptied, even if it contains few grounds. If this is not done, when you make the next coffees, the grounds container may fill up more than expected and clog the machine.
 <p>ON STEADILY</p>	After cleaning, the grounds container (A11) has not been replaced	Remove the drip tray (A15) and insert the grounds container.
 <p>ON STEADILY</p>  <p>FLASHING</p>	<p>The coffee beans have run out</p> <p>The pre-ground coffee funnel (A4) is clogged</p>	<p>Fill the beans container (A3 - fig. 9).</p> <p>Empty the funnel with the help of the brush (C5) as described in section "17.8 Cleaning the pre-ground coffee funnel".</p>
 <p>ON STEADILY</p>  <p>FLASHING</p>	<p>The pre-ground coffee function has been selected without placing any pre-ground coffee in the funnel (A4)</p> <p>The pre-ground coffee funnel (A4) is clogged</p>	<p>Place pre-ground coffee in the funnel (fig. 12) or deselect the "pre-ground" function.</p> <p>Empty the funnel with the help of the brush (C5) as described in section "17.8 Cleaning the pre-ground coffee funnel".</p>
 <p>FLASHING</p>	The machine must be descaled	The descaling procedure described in section "18. Descaling" needs to be performed.

LIGHTS DISPLAYED	POSSIBLE CAUSE	REMEDY
	<p>The grinding is too fine and the coffee is delivered too slowly or not at all</p> <p>If the water softener filter (C4) is present, an air bubble may have been released inside the circuit, obstructing delivery</p>	<p>Repeat coffee delivery and turn the grinding adjustment dial (A5 - fig. 8) one click clockwise towards "7" while the coffee grinder is in operation. If after making at least 2 coffees delivery is still too slow, repeat the correction procedure, turning the grinding adjustment dial another click until delivery is correct (see section "13.1 Adjusting the coffee grinder"). If the problem persists, make sure the water tank (A17) is fully inserted, turn the steam/hot water dial (A23) to the I position and deliver a little water until the flow is regular.</p> <p>Deliver a little water by turning the steam/hot water dial (A23) to the I position until the flow is regular.</p>
	<p>The pre-ground coffee used is too fine and the coffee is delivered too slowly or not at all</p> <p>If the water softener filter (C4) is present, an air bubble may have been released inside the circuit, obstructing delivery</p>	<p>Repeat coffee delivery using less pre-ground coffee, or a different type. If the problem persists, make sure the water tank (A17) is fully inserted, turn the steam/hot water dial (A23) to the I position and deliver a little water until the flow is regular.</p> <p>Deliver a little water by turning the steam/hot water dial (A23) to the I position until the flow is regular.</p>
	<p>A LONG coffee with pre-ground coffee has been requested</p>	<p>Put one level measure (C2) of pre-ground coffee into the pre-ground coffee funnel (A4) and press  OK (B15) to continue and complete preparation.</p>
	<p>Too much coffee has been used</p>	<p>Select a lighter taste by pressing  (B8) or reduce the quantity of pre-ground coffee.</p>
	<p>The  TrueBrew Over Ice™ button have been pressed without selection the aroma</p>	<p>Select the strength and then press the  True-Brew Over Ice™ button.</p>



LIGHTS DISPLAYED	POSSIBLE CAUSE	REMEDY
 FLASH. + FLASH.  FLASHING	The water circuit is empty	Turn the steam/hot water dial (A23) to the I position until delivery stops, then bring it back to the 0 position. If the alarm occurs while hot water or steam is being delivered, turn the dial to the 0 position. Turn the steam/hot water dial to the I position until delivery stops, then bring it back to the 0 position. If the problem persists, make sure the water tank (A17) is fully inserted.
 ON STEADILY	The inside of the machine is very dirty	Clean the inside of the machine thoroughly, as described in section “17. Cleaning”. If the message is still displayed after cleaning, contact Customer Services.
 FLASHING	The infuser (A8) has not been replaced after cleaning	Insert the infuser as described in section “17.9 Cleaning the infuser”.
 FLASHING	Indicates the steam/hot water dial (A23) must be turned on or off.	If steam/hot water dial is on, turn it off to the 0 position. If the steam/hot water dial is off, turn it on to the I position to deliver steam.
 FLASHING  ESC +  OK ON STEADILY	The machine must be descaled	The descaling procedure needs to be performed as soon as possible (see section “18. Descaling”).

23. TROUBLESHOOTING

Below is a list of some of the possible malfunctions.

If the problem cannot be resolved as described, contact Customer Services.

PROBLEM	POSSIBLE CAUSE	REMEDY
The coffee is not hot.	The cups were not preheated.	Warm the cups by rinsing them with hot water (Please note: you can use the hot water function).
	The internal circuits of the machine have cooled down because 2/3 minutes have elapsed since the last coffee was made.	Before making coffee, rinse the internal circuits by pressing the  icon (B15).
	A low coffee temperature is set.	Set a higher coffee temperature in the menu (see section “7. Setting temperature”).

PROBLEM	POSSIBLE CAUSE	REMEDY
The coffee is weak or not creamy enough.	The coffee is ground too coarsely.	Turn the grinding adjustment dial (A5) one click anticlockwise towards 1 while the coffee grinder is in operation (fig. 8). Continue one click at a time until coffee delivery is satisfactory. The effect is only visible after delivering 2 coffees (see section "13.1 Adjusting the coffee grinder").
The coffee is delivered too slowly or a drop at a time.	The coffee is ground too finely.	Turn the grinding adjustment dial (A5) one click clockwise towards 7 while the coffee grinder is in operation (fig. 8). Continue one click at a time until coffee delivery is satisfactory. The effect is only visible after delivering 2 coffees (see section "13.1 Adjusting the coffee grinder").
The machine will not make coffee	The machine has detected impurities in its internal circuits, the  light (B1) flashes	Wait for the machine to be ready for use again and reselect the required beverage. Contact Customer Services if the problem persists.
The infuser (A8) cannot be extracted	The machine has not been turned off correctly	Turn the machine off by pressing the  button (A24) (see section "5. Turning the machine off").
The frothed milk has large bubbles	The milk is not cold enough or is not semi-skimmed	You should ideally use skimmed or semi-skimmed milk at refrigerator temperature (about 5°C). If the result is not as you wished, try changing brand of milk.
The milk is not frothed	The ring on the cappuccino maker (A21) is in the "HOT MILK" position.	Push the ring into the "CAPPUCCINO" position.
	The frother (A22) and steam/hot water connection nozzle (A21) are dirty	Clean as described in section "15.2 Cleaning the frother after use".
At the end of descaling, the machine requests a third rinse	During the two rinse cycles, the water tank has not been filled to the MAX level.	Follow the instructions displayed by the machine, but first empty the drip tray (A15) to avoid the water overflowing.
Steam delivery stops	A safety device stops steam delivery	Wait a few minutes and then enable the steam function again.
The machine does not turn on	The machine is not plugged into the mains socket	Plug into the mains socket (fig. 1).
	The main switch (A6) is not turned on	Press the main switch (fig. 1).
Coffee does not come out of one or both of the coffee spouts	The coffee spouts (A19) are blocked	Clean as described in section "17.7 Cleaning the coffee spouts".