

CONTENTS

1. FUNDAMENTAL SAFETY WARNINGS.....	7
2. SAFETY WARNINGS	8
2.1 Symbols used in these instructions	8
2.2 Designated use.....	8
2.3 Instruction for Use.....	8
3. INTRODUCTION.....	8
3.1 Letters in brackets.....	8
3.2 Troubleshooting and repairs.....	8
4. DESCRIPTION.....	9
4.1 Description of the appliance	9
4.2 Description of the accessories.....	9
4.3 Description of the milk container	9
5. BEFORE USE.....	9
5.1 Checking the appliance	9
5.2 Installing the appliance.....	9
5.3 Connecting the appliance.....	10
5.4 Setting up the appliance	10
6. TURNING THE APPLIANCE ON.....	10
7. TURNING THE APPLIANCE OFF	10
8. MENU SETTINGS	11
8.1 Language.....	11
8.2 Maintenance	11
8.3 Program beverages	11
8.4 Program My beverages.....	11
8.5 General	11
8.6 Statistics.....	12
9. RINSING.....	12
10. MAKING COFFEE.....	13
10.1 Adjusting the coffee mill	13
10.2 Tips for a hotter coffee.....	13
10.3 Making automatic recipes using coffee beans	13
10.4 Temporarily varying the coffee aroma.....	14
10.5 Making coffee using pre-ground coffee.....	14
11. MAKING CAPPUCCINOS AND MILK-BASED COFFEES.....	14
11.1 Filling and attaching the milk container.....	15
11.2 Adjusting the amount of froth.....	15
11.3 Making cappuccino and milk-based coffees automatically.....	15
11.4 Cleaning the milk container after use	15
12. "my MENU " PROGRAMMING AND SELECTING..	16
13. DELIVERING HOT WATER	16
14. CLEANING.....	16
14.1 Cleaning the machine	16
14.2 Cleaning the machine's internal circuit	16
14.3 Cleaning the coffee grounds container	17
14.4 Cleaning the drip tray and condensate tray	17
14.5 Cleaning the inside of the coffee machine.....	17
14.6 Cleaning the water tank.....	17
14.7 Cleaning the coffee spouts	17
14.8 Cleaning the pre-ground coffee funnel	17
14.9 Cleaning the infuser	17
14.10 Cleaning the milk container	18
14.11 Cleaning the hot water nozzle.....	18
15. DESCALING.....	18
16. SETTING WATER HARDNESS	19
16.1 Measuring water hardness.....	19
16.2 Setting water hardness	19
17. WATER SOFTENER FILTER	19
17.1 Installing the filter	20
17.2 Replacing the filter.....	20
17.3 Removing the filter	21
18. TECHNICAL DATA.....	21
19. DISPOSING OF THE APPLIANCE	21
20. DISPLAYED MESSAGES.....	21
21. TROUBLESHOOTING	24
22. ELECTRICAL REQUIREMENTS.....	26

1. FUNDAMENTAL SAFETY WARNINGS

- The appliance is not intended for use by persons (including children) with reduced physical, sensory or mental capabilities, or lack of experience and knowledge, unless they have been given supervision or instruction concerning use of the appliance by a person responsible for their safety.
- Children should be supervised to ensure that they do not play with the appliance.
- Designated use: this appliance is designed and made to prepare coffee and milk based beverages and hot water. Any other use is considered improper and thus dangerous. The manufacturer is not liable for damage deriving from improper use of the appliance.
- The surface of the heating element remains hot after use and the outside of the appliance may retain the heat for several minutes depending on use.
- To clean, follow the instructions in the section "15. CLEANING".
- Cleaning and user maintenance shall not be made by children without supervision.
- Never clean by immersing the appliance in water.
- CAUTION: To prevent damage to the appliance do not use alkaline cleaning agents when cleaning, use a soft cloth and a mild detergent
- This is a household appliance only. It is not intended to be used in: staff kitchen areas in shops, offices and other working environments; farm houses; by clients in hotels, motels and other residential type environments; bed and breakfast type environments.
- If the plug or cord is damaged, it must be replaced by Customer Services only to avoid all risk.
- Appliances with removable cord: avoid splashes of water on the power cord connector or socket at the back of the appliance.

FOR EUROPEAN MARKETS ONLY:

- This appliance can be used by children aged from 8 years and above if they have been given supervision or instruction concerning use of the appliance in a safe way and if they understand the hazard involved. Cleaning and user maintenance shall not be made by children unless they are older than 8 and supervised.
Keep the appliance and its cord out of the reach of children aged less than 8 years.
- Appliances can be used by persons with reduced physical, sensory or mental capabilities or lack of experience and knowledge if they have been given supervision or instruction concerning use of the appliance in a safe way and if they understand the hazards involved.
- Children shall not play with the appliance.

- When not in use and before putting on or taking off parts or cleaning, always unplug the appliance.



Surfaces marked with this symbol become hot during use (the symbol is present in certain models only).

2. SAFETY WARNINGS

2.1 Symbols used in these instructions

Important warnings are identified by these symbols. It is vital to respect these warnings.



Danger!

Failure to observe the warning may result in life threatening injury by electric shock.



Important!

Failure to observe the warning could result in injury or damage to the appliance.



Danger of burns!

Failure to observe the warning could result in scalds or burns.



Please note:

This symbol identifies important advice or information for the user.



Danger!

This is an electrical appliance and may cause electric shock. You should therefore follow these safety warnings:

- Never touch the appliance with damp hands or feet.
- Never touch the plug with damp hands.
- Make sure the socket used is freely accessible at all times, enabling the appliance to be unplugged when necessary.
- Unplug directly from the plug only. Never pull the cord as you could damage it.
- To disconnect the appliance completely you must unplug it from the mains socket.
- If the appliance is faulty, do not attempt to repair. Turn it off, unplug from the mains socket and contact Customer Services.
- Before cleaning the appliance, turn it off, unplug from the mains socket and allow to cool.



Important:

Keep all packaging (plastic bags, polystyrene foam) away from children.



Danger of burns!

This appliance produces hot water and steam may form while it is in operation.

Avoid contact with splashes of water or hot steam.

When the appliance is in operation, the cup shelf could become very hot.

2.2 Designated use

This appliance is designed and made to prepare coffee and heat beverages.

Any other use is considered improper and thus dangerous. The manufacturer is not liable for damage deriving from improper use of the appliance.

2.3 Instruction for Use

Read this Instruction for Use carefully before using the appliance. Failure to follow this Instruction for Use may result in burns or damage to the appliance.

The manufacturer is not liable for damage deriving from failure to respect this Instruction for Use.



Please note:

Keep this Instruction for Use. If the appliance is passed to other persons, they must also be provided with this Instruction for Use.

3. INTRODUCTION

Thank you for choosing this bean to cup espresso and cappuccino machine.

We hope you enjoy using your new appliance. Take a few minutes to read this Instruction for Use. This will avoid all risks and damage to the appliance.

3.1 Letters in brackets

The letters in brackets refer to the legend in the description of the appliance on pages 2-3.

3.2 Troubleshooting and repairs

In the event of problems, first try and resolve them by reading the information given in sections "20. Displayed messages" and "21. Troubleshooting".

If this does not resolve the problem or you require further information, you should consult Customer Services by calling the number given on the annexed "Customer Service" sheet.

If your country is not among those listed on the sheet, call the number given in the guarantee. If repairs are required, contact De'Longhi Customer Services only. The addresses are given in the guarantee certificate provided with the machine.

4. DESCRIPTION

4.1 Description of the appliance





(page 3 - A)

- A1. Beans container lid
- A2. Pre-ground coffee funnel lid
- A3. Beans container
- A4. Pre-ground coffee funnel
- A5. Grinding adjustment dial
- A6. Cup shelf
- A7.  button: to turn the appliance on and off (standby)
- A8. Hot water and steam connection nozzle
- A9. Coffee spouts (adjustable height)
- A10. Condensate tray
- A11. Coffee grounds container
- A12. Cup tray
- A13. Drip tray water level indicator
- A14. Drip tray grille
- A15. Drip tray
- A16. Water tank lid
- A17. Water tank
- A18. Water softener filter housing
- A19. Infuser door
- A20. Infuser
- A21. Power cord connector socket
- A22. Main switch

Description of the touch screen



(page 2 - B)

A number of buttons on the panel have a double function. This is indicated in brackets in the description.

- B1. Display: guides the user in using the appliance. The current selection is at the centre between two dotted lines.
- B2.  Selection arrow ("ESC": when programming beverages, press to exit without saving the change)
- B3. **OK**: to confirm the selection (During the first few seconds of "espresso", "Ristretto" or "Espresso lungo" delivery, press for 2 cups)
- B4.  Selection arrow ("STOP" - When delivering/programming beverages, press to interrupt/programme)
- B5. /ESC: to perform a rinse cycle.
(When in the settings menu, it acts as the "ESC" button to exit from the selected function and go back to the main menu)
- B6. : appliance settings menu
- B7. : aroma selection

Directly selected beverages:

- B8. : Espresso
- B9. : Coffee
- B10. : Cappuccino
- B11. : Latte Macchiato

- B12.  DRINK MENU : Beverage selection menu (other than directly selected beverages): Espresso lungo, Ristretto, Long, Doppio+, Caffelatte, Flat white, Hot milk, 2xEspresso, 2 x Espresso lungo, 2x Ristretto, Hot Water
- B13.  MY MENU : My beverages selection menu. Unless previously programmed from the settings menu ("8.4 Program My beverages"), the beverage is programmed directly the first time you use the appliance.

4.2 Description of the accessories

(page 2 - C)

- C1. Indicator paper
- C2. Pre-ground coffee measure
- C3. Descaler
- C4. Water softener filter (certain models only)
- C5. Cleaning brush
- C6. Hot water spout
- C7. Power cord

4.3 Description of the milk container

(page 2 - D)

- D1. Froth adjustment and CLEAN dial
- D2. Milk container lid
- D3. Milk container
- D4. Milk intake tube
- D5. Frothed milk spout (adjustable)

5. BEFORE USE

5.1 Checking the appliance

After removing the packaging, make sure the product is complete and undamaged and that all accessories (C) are present. Do not use the appliance if it is visibly damaged. Contact De'Longhi Customer Services.

5.2 Installing the appliance

Important!

When you install the appliance, you should respect the following safety warnings:

- The appliance gives off heat. After positioning the appliance on the worktop, leave a space of at least 3 cm between the surfaces of the appliance and the side and rear walls and at least 15 cm above the coffee maker.
- Water penetrating the coffee machine could cause damage.
Do not place the appliance near taps or sinks.
- The appliance could be damaged if the water it contains freezes.
Do not install the appliance in a room where the temperature could drop below freezing point.

- Arrange the cord (C7) in such a way that it cannot be damaged by sharp edges or contact with hot surfaces (e.g. electric hot plates).

5.3 Connecting the appliance



Important!

Check that the mains power supply voltage corresponds to that indicated on the rating plate on the bottom of the appliance.

Connect the appliance to an efficiently earthed and correctly installed socket with a minimum current rating of 10A only.

If the power socket does not match the plug on the appliance, have the socket replaced with a suitable type by a qualified professional.

5.4 Setting up the appliance



Please note:

- Coffee has been used to factory test the appliance and it is therefore completely normal for there to be traces of coffee in the mill. The machine is, however, guaranteed to be new.
 - You should customise water hardness as soon as possible following the instructions in section "16. Setting water hardness".
1. Plug the power cord (C7) connector into the socket (A21) at the back of the appliance and connect the appliance to the mains electricity supply (fig. 1). Make sure the main switch (A22) at the back of the appliance is pressed (fig. 2);
 2. "Language": press the selection arrow (B2) until the required language is displayed between the two dotted lines, then press **OK** (B3) to confirm.

Then follow the instructions indicated on the appliance display (B1):

3. "Fill tank": remove the water tank (A17), fill to the MAX line with fresh water (fig. 3A), then replace in the appliance (fig. 3B);
4. "Insert water spout": Check that the hot water spout (C6) is inserted on the connection nozzle (A8) (fig. 4) and place a container holding a minimum of 100 ml underneath (fig. 5);
5. "Water circuit empty, Fill water circuit, Hot water, Confirm?";
6. Press the **OK** button to confirm. The appliance delivers hot water from the spout then goes off automatically.

The coffee machine is now ready for normal use.



Please note:

- The first time you use the coffee maker, you need to make 4-5 cups of coffee or 4-5 cappuccinos before it starts to give satisfactory results.

- When making the first 5-6 cappuccinos, it is normal to hear the noise of boiling water. After this, the noise becomes less.
- To enjoy your coffee even more and improve the performance of your appliance, we recommend installing a water softener filter (C4) as described in section "17. Water softener filter". If your model is not provided with a filter, you can request one from De'Longhi Customer Services.

6. TURNING THE APPLIANCE ON



Please note:

Before turning the appliance on, make sure the main switch (A22) on the back of the appliance is pressed (fig. 2).

Each time the appliance is turned on, it performs an automatic preheat and rinse cycle which cannot be interrupted. The appliance is ready for use only after completion of this cycle.



Danger of burns!

During rinsing, a little hot water comes out of the coffee spouts (A9) and is collected in the drip tray (A15) underneath. Avoid contact with splashes of water.

- To turn the appliance on, press the  button (A7) (fig. 6). The message "Heating Please wait" appears on the display (B1).

After heating, the message "Rinsing" is displayed, together with a progress bar which gradually fills as preparation proceeds. As well as heating the boiler, the appliance also heats the internal circuits by circulating hot water.

The appliance is at temperature when the message "Select your beverage" is displayed.

7. TURNING THE APPLIANCE OFF

Whenever the coffee machine is turned off after being used to make coffee, it performs an automatic rinse cycle.



Danger of burns!

During rinsing, a little hot water flows from the coffee spouts (A9). Avoid contact with splashes of water.

- To turn the appliance off, press the  button (A7) (fig. 6);
- The message "Turning off underway Please wait" appears on the display (B1), then the appliance performs a rinse cycle and goes off (standby).



Please note!

If you will not be using the appliance for some time, unplug from the mains socket:

- first turn the appliance off by pressing the  button (fig. 6);
- press the main switch (A22) (fig. 2).

Important!

Never press the main switch while the appliance is on.



8. MENU SETTINGS

The menu has 6 items, some divided into subgroups:

- **Language;**
- **Maintenance:**
 - Descale,
 - Install filter,
 - (if a filter has been installed): Replace filter,
 - (if a filter has been installed): Remove filter;
- **Prg. beverages;**
- **Prg. my beverages;**
- **General:**
 - Set temperature,
 - Water hardness,
 - Auto-off,
 - Energy saving,
 - Beep,
 - Default beverages,
 - Default values;
- **Statistics.**

8.1 Language

To modify the language of the display (B1), proceed as follows:

1. Press  (B6) to enter the "Settings" menu;
2. Press **OK** (B3) to select "Language". The available languages are displayed;
3. Press the selection arrows (B2 and B4) until the required language is displayed between the two lines;
4. Press **OK** to confirm;
5. The appliance goes back to the "Settings" menu;
6. Press /ESC (B5) to exit the menu.

8.2 Maintenance

Here you can find all the maintenance operations required by the appliance over time:

- **Descale:** For instructions on descaling, see section "15. Descaling".
- **Install filter:** For instructions on how to install the filter (C4), see section "17.1 Installing the filter".



To select the operation you require, proceed as follows:

1. Press  (B6) to enter the "Settings" menu;
2. Press the selection arrows (B2 and B4) until "Maintenance" is displayed between the two lines;
3. Press **OK** (B3) to confirm;



4. Press the selection arrows to display the operation to be performed;
5. Press **OK** to confirm and perform the operations as described in the corresponding sections.

8.3 Program beverages

The appliance is set by default to automatically deliver standard quantities. To change these quantities and customise the directly selected beverages and the  DRINK MENU (B12), proceed as follows:

1. Press  (B6) to enter the "Settings" menu;
2. Press the selection arrows (B2 and B4) until "Prg. beverages" is displayed between the two lines;
3. Press **OK** (B3) to confirm: the appliance lists the beverages you can customise;
4. Press the selection arrows until the beverage you want to customise is displayed, then press **OK** to confirm;
5. **Beverages with coffee:** "Program aroma" appears on the display: press the selection arrows (B2 and B4) or  (B7) until the required aroma is selected (see section "10.4 Temporarily varying the coffee aroma"), then press **OK**. "Program coffee" appears on the display together with a bar which gradually fills as delivery progresses. When the required quantity is reached, press **OK**;
Cappuccinos and milk-based coffees: after selecting the aroma, "Program milk" appears on the display together with a bar which gradually fills as milk delivery progresses. When the required quantity is reached, press **OK**. The appliance then makes the coffee. Press **OK** to interrupt delivery when the required quantity of coffee is reached.
Hot water: press **OK**. Delivery begins: press **OK** when the required quantity is reached.
6. "Save parameters?": to save the settings, press **OK** (otherwise press /ESC - B2 or B5).
7. "Parameters saved" (or "Parameters not saved"). The appliance is ready for use again.

8.4 Program My beverages

Follow the procedures described in the previous section "8.3 Program beverages" to customise the beverages in the  MENU (B13) or proceed with direct programming, as described in section "12.  MENU " Programming and selecting".

8.5 General

Here you can find the settings to customise the basic functions of the appliance:

1. Press  (B6) to enter the "Settings" menu;
2. Press the selection arrows (B2 and B4) until "General" is displayed between the two lines;

3. Press **OK** (B3) to confirm and select the required item with the selection arrows. Then follow the instructions for each setting.

- **Set temperature:**

To modify the temperature of the water used to make the coffee, proceed as follows:

4. Press **OK** (B3). The current value appears on the display (B1) and the "New" value flashes;
5. Select the new value you want to set using the selection arrows (B2 or B4);
6. When the required value (low, medium, high, maximum) has been selected, press **OK**.

The display goes back to the previous screen.

- **Water hardness:**

For instructions on identifying and setting water hardness, see section "16. Setting water hardness".

- **Auto-off (standby):**

Auto-off can be set so that the appliance goes off after 15 or 30 minutes, or 1, 2 or 3 hours

4. Press **OK**. The current value appears on the display (B1) and the "New" value flashes;
5. Select the new value you want to set using the selection arrows (B2 or B4);
6. When the required value (low, medium, high, maximum) has been selected, press **OK**.

The display goes back to the previous screen.

- **Energy saving:**

Use this function to enable or disable energy saving. When enabled, the function reduces energy consumption in compliance with European regulations.

To disable or enable "Energy Saving", proceed as follows:

4. Press **OK**. The current state ("Enabled" or "Disabled") and the operation to be performed ("Disable?" or "Enable?") is displayed. Press **OK** to confirm;
5. Press **OK** to disable or enable the function.

The display goes back to the previous screen.

 **Please note!**

- when the function is enabled, the symbol "ECO" appears on the display.
- When in energy saving mode, a few seconds elapse before the first coffee, cappuccino or milk-based coffee is delivered as the appliance must heat up again.
- If the milk container (D) is inserted, "Energy Saving" cannot be activated.

- **Beep:**

Use this function to enable or disable the beep. Proceed as follows:

4. Press **OK**. The current state ("Enabled" or "Disabled") and the operation to be performed ("Disable?" or "Enable?") is displayed. Press **OK** to confirm;
5. Press **OK** to disable or enable the function. The display goes back to the previous screen.

- **Default beverages:**

Use this function to reset the default values for all the beverages, or the individual beverages programmed previously. Select the beverage, then proceed as follows:

4. Select "All" to reset the aroma and quantity settings to the default values, or select the required beverage, then press **OK**;
5. "Reset?": to reset the default values, press **OK**.
6. "Reset complete": the appliance confirms the reset and goes back to the previous screen.

To reset another beverage, repeat from point 4 or to exit, press /ESC (B5).

- **Default values:**



Use this function to reset all the appliance and beverage settings (apart from the language which remains as selected the first time the appliance was used). Select the item, then proceed as follows:

4. "Reset?"; press **OK**;
5. "Reset complete": the appliance confirms the reset and goes back to the previous screen.

To exit, press /ESC (B5).

8.6 Statistics

This displays statistics relating to the machine. To display the statistics, proceed as follows:

1. Press  (B6) to enter the "Settings" menu;
2. Press the selection arrows (B2 and B4) until "Statistics" is displayed between the two lines;
3. Press **OK** (B3): statistics on the appliance are displayed, use the selection arrows to scroll through the items;
4. Press /ESC (B5) to exit.

To go back to the main screen, press /ESC.

9. RINSING

Use this function to deliver hot water from the coffee spouts (A9) and hot water spout (C6), if inserted, to clean and heat the appliance's internal circuit.

Place a container with a minimum capacity of 100ml under the coffee and hot water spouts.



Important! Danger of burns.

Do not leave the appliance unattended while hot water is being delivered.

- 1) To enable this function, press  (B5). "RINSING" appears on the display (B1);
- 2) After a few seconds, hot water is delivered first from the coffee spouts, then from the hot water spout (if inserted) to clean and heat the appliance's internal circuit. A progress bar is displayed and fills gradually as preparation proceeds;
- 3) To interrupt, press the arrow corresponding to "STOP" (B4).

i Please note!

- If the appliance is not used for more than 3-4 days, when switched on again, we strongly recommend performing 2/3 rinses before use;
- After cleaning, it is normal for the coffee grounds container (A11) to contain water.

10. MAKING COFFEE

10.1 Adjusting the coffee mill

The coffee mill is set by default to prepare coffee correctly and should not require regulating initially.

However, if after making the first few coffees you find that the coffee is either too weak and not creamy enough or delivery is too slow (a drop at a time), this can be corrected by adjusting the grinding dial (A5) (fig. 7).

i Please note:

The grinding adjustment dial must only be turned when the coffee mill is in operation.



If the coffee is delivered too slowly or not at all, turn one click clockwise towards 7. For fuller bodied creamier coffee, turn one click anticlockwise towards 1 (do not turn more than one click at a time otherwise the coffee could be delivered a drop

at a time).

These adjustments will only be evident after at least 2 cups of coffee have been delivered. If this adjustment does not obtain the desired result, turn the dial another click.

10.2 Tips for a hotter coffee

For hotter coffee, you should:













- to rinse, press /ESC (B5);
- warm the cups with hot water using the hot water function (see section "13. Delivering hot water");
- increase the coffee temperature in the "Settings" menu (see section "8.5 General").

10.3 Making automatic recipes using coffee beans

! Important!

Do not use green, caramelised or candied coffee beans as they could stick to the coffee mill and make it unusable.

1. Fill the container (A3) (fig. 8) with coffee beans;
2. Place under the coffee spouts (A9):
 - 1 cup, if you want to make 1 coffee (fig. 9);
 - 2 cups if you want 2 coffees.
3. Lower the spouts as near as possible to the cup. This makes a creamier coffee (fig. 10);
4. Then select your required coffee:

Directly selected beverages			
Recipe	Quantity	Program-mable quantity	Default aroma
 Espresso (B8)	≈ 40 ml	from ≈30 to ≈ 80ml	
 Coffee (B9)	≈ 180 ml	from ≈100 to ≈240ml	
Beverages with coffee selectable from the  DRINK MENU (B14)			
Espresso lungo	≈ 120 ml	from ≈80 to ≈180ml	
Rispresso	≈ 30 ml	from ≈20 to ≈40ml	
Long	≈ 160 ml	from ≈115 to ≈250ml	
Doppio+	≈ 120 ml	from ≈80 to ≈180ml	
2 Espresso	≈ 40 ml x 2 cups	--	
2 Espresso lungo	≈ 120 ml x 2 cups	--	
2 Ristretto	≈ 30 ml x 2 cups	--	

5. Preparation begins. A progress bar appears on the display (B1) and gradually fills as preparation proceeds.

i Please note:

- You can prepare 2 cups of Ristretto, ESPRESSO or Espresso lungo coffee at the same time by pressing "2X" (B3) during preparation of single beverages (the image is displayed for a few seconds at the start of preparation).

- While the machine is making coffee, delivery can be interrupted at any time by pressing the selection arrow corresponding to "STOP" (B4).
- At the end of delivery, to increase the quantity of coffee in the cup, just press and hold (within 3 seconds) one of the coffee buttons (B8 or B10).







Once the coffee has been made, the appliance is ready to make the next beverage.

i Please note:



- Various alarm messages could be displayed while using the appliance (fill tank, empty grounds container, etc.). Their meaning is explained in section "20. Displayed messages".
- For hotter coffee, see section "10.2 Tips for a hotter coffee".
- If the coffee is delivered a drop at a time, too weak and not creamy enough or too cold, read the tips in section "21. Troubleshooting".
- To customise the beverages according to personal taste, see sections "8.3 Program beverages" and "8.4 Program My beverages".

10.4 Temporarily varying the coffee aroma

To temporarily vary the aroma of the coffee in the automatic recipes, press  (B7):

	Custom (if programmed) / Standard
	EXTRA LIGHT
	LIGHT
	MEDIUM
	STRONG
	X-STRONG
	(see "10.5 Making coffee using pre-ground coffee")

i Please note:

- The variation in aroma is not saved and the next time a beverage is delivered automatically, the appliance selects the default value ( AUTO).
- If a few seconds elapse between temporary customising of the aroma and delivery of the beverage, the aroma returns to the default value ( AUTO).



10.5 Making coffee using pre-ground coffee



! Important!

- Never add pre-ground coffee when the machine is off or it could spread through the inside of the machine and dirty it. This could damage the appliance.
- Never use more than 1 level measure (C2) or it could dirty the inside of the coffee machine or block the funnel (A4).

i Please note:

If you use pre-ground coffee, you can only make one cup of coffee at a time.

1. Press the  button (B7) repeatedly until "" appears on the display (B1).
2. Make sure the funnel is not blocked, then add one level measure of pre-ground coffee (fig. 11).
3. Place a cup under the coffee spouts (A9) (fig. 9).
4. Then select your required coffee:

Directly selected beverages	
Recipe	Quantity
 Espresso (B8)	≈ 40 ml
 Coffee (B9)	≈ 180 ml
Beverages with coffee selectable from the  DRINK MENU (B12)	
Espresso lungo	≈ 120 ml
Ristretto	≈ 30 ml
Long	≈ 160 ml

5. Preparation begins. The beverage selected appears on the display together with a progress bar which gradually fills as preparation proceeds.

! Important! Making LONG coffee :

Halfway through preparation, the message "Add pre-ground coffee" appears on the display (B1). Add one level measure of pre-ground coffee and press **OK** (B3).

i Please note:

If "Energy Saving" mode is active, you may have to wait a few seconds before the first coffee is delivered.

11. MAKING CAPPUCCINOS AND MILK-BASED COFFEES

i Please note:

- To avoid milk with poor froth or large bubbles, always clean the milk container lid (D2) and hot water connection nozzle (A8) as described in sections "11.4 Cleaning the milk

container after use”, “14.10 Cleaning the milk container” and “14.11 Cleaning the hot water nozzle”.

11.1 Filling and attaching the milk container



1. Remove the lid (D2) (fig. 12);
2. Fill the milk container (D3) with a sufficient quantity of milk, not exceeding the MAX level marked on the handle (fig. 13). Each mark on the side of the container corresponds to 100ml of milk;

i Please note:

- For a denser more even froth, you must use skimmed or partially skimmed milk at refrigerator temperature (about 5°C).
 - If "Energy Saving" mode is enabled, you may have to wait a few seconds before the first cappuccino is delivered.
3. Make sure the milk intake tube (D4) is correctly inserted in the bottom of the milk container lid (fig. 14);
 4. Place the lid back on the milk container;
 5. Remove the hot water spout (C6) from the connection nozzle (A8) (fig. 15);
 6. Attach the container to the connection nozzle and push as far as it will go (fig. 16). The machine emits a beep (if enabled);
 7. Place a sufficiently large cup under the coffee spouts (A9) and frothed milk spout (D5). Adjust the length of the milk spout. To move it nearer the cup, simply pull it downwards (fig. 17);
 8. Follow the instructions below for each function.

11.2 Adjusting the amount of froth

Turn the froth adjustment dial (D1) to adjust the amount of froth on the milk delivered while making cappuccinos and milk-based coffees.

Dial position	Description	Recommended for. . .
	No froth	HOT MILK (not frothed) / CAFFELATTE
	Min. froth	LATTE MACCHIATO / FLAT WHITE
	Max. froth	CAPPUCCINO/ CAPPUCCINO+ / ESPRESSO MACCHIATO / HOT MILK (frothed)

11.3 Making cappuccino and milk-based coffees automatically

1. Fill the milk container (D) and attach it as described above;
2. Select the required beverage:

Directly selected beverages:

-  : CAPPUCCINO (B10)
-  : Latte Macchiato (B11)

Select by pressing ^{DRINK} _{MENU} (B12):

- Caffe latte
 - Flat white
 - Hot milk
3. After a few seconds, preparation begins automatically, a progress bar appears on the display and gradually fills as preparation proceeds;
 4. After delivering the milk, the machine automatically makes the coffee (if required by the recipe).

i Please note:

- If you want to interrupt preparation during delivery, press the arrow corresponding to "STOP" (B4).
- Do not leave the milk container out of the refrigerator for long periods. The warmer the milk (5°C is ideal), the poorer the quality of froth produced.
- The beverages can be customised (see sections “8.3 Program beverages” and “8.4 Program My beverages”).

11.4 Cleaning the milk container after use

⚠ Important! Danger of burns

- When cleaning the internal tubes of the milk container (D), a little hot water and steam leak out of the milk spout (D5). Avoid contact with splashes of water.

"Set dial to CLEAN, ESC to cancel" appears on the display (B1) each time you use a milk function. Clean as described to eliminate all milk residues (or press /ESC" (B5) to clean later):

1. Leave the milk container (D) in the machine (you do not need to empty it);
2. Place a cup or other recipient under the frothed milk spout;
3. Turn the froth adjustment dial (D1) to "CLEAN" (fig. 19). "Cleaning underway" appears on the display, together with a progress bar which gradually fills as the operation proceeds. Cleaning stops automatically;
4. Turn the dial back to one of the froth selections;
5. Remove the milk container and always clean the steam connection nozzle (A8) with a sponge (fig. 20).

i Please note!

- To prepare a number of cappuccinos or milk-based coffees, clean the milk container after you have prepared the last beverage only. In this case, press /ESC (B5) to go back to the main menu.
- The milk container can be kept in the refrigerator.
- In some cases, before cleaning you must wait for the appliance to heat up.

12. "my MENU" PROGRAMMING AND SELECTING

In **my MENU** you can select beverages customised to your personal tastes. If the beverages have not yet been programmed, the appliance will request the customisation procedure before proceeding with delivery:

1. Press **my MENU** (B13);
2. Press the selection arrows (B2 and B4) until the required beverage is displayed between the two lines;

Unprogrammed beverages:

3. Press **OK** (B3) to select;
4. **Beverages with coffee:** "Program aroma" appears on the display. Press the selection arrows (B2 and B4) or **⏪** (B7) until the required aroma is selected. Press **OK**. "Program coffee" appears on the display together with a bar which gradually fills as delivery progresses. When the required quantity is reached, press **OK**.
5. **Cappuccinos and milk-based coffees:** After selecting the aroma, "Program milk" appears on the display together with a bar which gradually fills as milk delivery progresses. When the required quantity is reached, press **OK**.
6. The appliance then makes the coffee. Press **OK** to interrupt delivery when the required quantity of coffee is reached.
7. "Save parameters?": to save the settings, press **OK** (otherwise press **ESC** - B2 or B5).
8. "Parameters saved" (or "Parameters not saved"). The appliance is ready for use again.

Programmed beverages:

3. Press **OK** (B3) to select;
4. Preparation begins according to the previously programmed settings.

Please note:

Two cups of a beverage can only be selected when the corresponding single beverages have been programmed.

13. DELIVERING HOT WATER

Important! Danger of burns.

Never leave the machine unattended while delivering hot water.

1. Make sure the hot water spout (C6) is attached correctly;
2. Place a container under the water spout (as close as possible to avoid splashes) (fig. 5);
3. Press **☰** **DRINK MENU** (B12) and scroll through the beverages in the menu by pressing the selection arrows (B2 or B4) until "Hot water" is selected;
4. Press **OK** (B3). A progress bar appears and gradually fills as preparation proceeds;
5. The machine delivers about 250 ml of hot water, then delivery stops automatically. To interrupt hot water deliv-

ery manually, press the selection arrow corresponding to "STOP" (B4) again.

Please note:

- If "Energy Saving" mode is active, you may have to wait a few seconds before hot water is delivered.
- The quantity of water delivered can be customised (see section "8.3 Program beverages").

14. CLEANING

14.1 Cleaning the machine

The following parts of the machine must be cleaned regularly:

- the appliance's internal circuit;
- coffee grounds container (A11);
- drip tray (A15) and condensate tray (A10);
- water tank (A17);
- coffee spouts (A9);
- pre-ground coffee funnel (A4);
- infuser (A20), accessible after opening the infuser door (A19);
- milk container (D);
- hot water/steam connection nozzle (A8);

Important!

- Do not use solvents, abrasive detergents or alcohol to clean the coffee machine. With De'Longhi superautomatic coffee machines, you need not use chemical products to clean the machine.
- None of the components of the appliance can be washed in a dishwasher with the exception of the drip tray grille (A14) and milk container (D).
- Do not use metal objects to remove encrustations or coffee deposits as they could scratch metal or plastic surfaces.

14.2 Cleaning the machine's internal circuit

If the appliance is not used for more than 3/4 days, before using it again, we strongly recommend switching it on and:

- performing 2/3 rinse cycles by pressing **☺** (B5);
- delivering hot water for a few seconds (section "13. Delivering hot water").

Please note:

After cleaning, it is normal for the coffee grounds container (A11) to contain water.

14.3 Cleaning the coffee grounds container

When "Empty grounds container" appears on the display (B1), the grounds container must be emptied and cleaned. The appliance cannot be used to make coffee until you have cleaned the grounds container (A11). Even if not full, the empty grounds container message appears on the display 72 hours after the

first coffee has been prepared. For the 72 hours to be calculated correctly, the machine must never be turned off with the main switch (A22).



Important! Danger of burns

If you make a number of cappuccinos one after the other, the metal cup tray (A12) becomes hot. Wait for it to cool down before touching it and handle it from the front only.

To clean (with the machine on):

- Remove the drip tray (A15) (fig. 21), empty and clean.
- Empty the grounds container (A11) and clean thoroughly to remove all residues left on the bottom. This can be done with the spatula on the brush (C5) provided.
- Check the condensate tray (A10) (red) and empty if necessary.



Important!

When removing the drip tray, the grounds container must be emptied, even if it contains few grounds.

If this is not done, when you make the next coffees, the grounds container may fill up more than expected and clog the machine.

14.4 Cleaning the drip tray and condensate tray



Important!

The drip tray (A15) is fitted with a level indicator (A13) (red) showing the level of water it contains (fig. 22). Before the indicator protrudes from the cup tray (A12), the drip tray must be emptied and cleaned otherwise the water may overflow the edge and damage the appliance, the surface it rests on or the surrounding area.

To remove the drip tray:

1. Remove the drip tray and the coffee grounds container (A11) (fig. 21);
2. Remove the cup tray (A12) and drip tray grille (A14), then empty the drip tray and grounds container and wash all components;
3. Check the red condensate tray (A10) and empty if necessary;
4. Replace the drip tray complete with grille and grounds container.

14.5 Cleaning the inside of the coffee machine



Danger of electric shock!

Before cleaning internal parts, the machine must be turned off (see section "7. Turning the appliance off") and unplugged from the mains power supply. Never immerse the coffee machine in water.

1. Check regularly (about once a month) that the inside of the appliance (accessible after removing the drip tray, A15) is not dirty. If necessary, remove coffee deposits with the brush (C5) supplied and a sponge;
2. Remove all the residues with a vacuum cleaner (fig. 23).

14.6 Cleaning the water tank

1. Clean the water tank (A17) regularly (about once a month) and whenever you replace the water softener filter (C4) (if provided) with a damp cloth and a little mild washing up liquid;
2. Remove the filter (C4) (if present) and rinse with running water;
3. Replace the filter (if provided), fill the tank with fresh water and replace the tank;
4. (Models with water softener filter only) Deliver about 100ml of water.

14.7 Cleaning the coffee spouts

1. Clean the coffee spouts (A9) regularly with a sponge or cloth (fig. 24A);
2. Check that the holes in the coffee spouts are not blocked. If necessary, remove coffee deposits with a toothpick (fig. 24B).

14.8 Cleaning the pre-ground coffee funnel

Check regularly (about once a month) that the pre-ground coffee funnel (A4) is not blocked. If necessary, remove coffee deposits with the brush (C5) supplied.

14.9 Cleaning the infuser

The infuser (A20) must be cleaned at least once a month.



Important!

The infuser may not be extracted when the machine is on.

1. Make sure the machine is correctly turned off (see "7. Turning the appliance off");
2. Remove the water tank (A17);
3. Open the infuser door (A19) (fig. 25) on the right side of the appliance;
4. Press the two coloured release buttons inwards and at the same time pull the infuser outwards (fig. 26);
5. Soak the infuser in water for about 5 minutes, then rinse under the tap;



Important!

RINSE WITH WATER ONLY

NO WASHING UP LIQUID - NO DISH WASHER

Clean the infuser without using washing up liquid as it could be damaged.

- Use the brush (C5) to remove any coffee residues left in the infuser housing, visible through the infuser door;
- After cleaning, replace the infuser by sliding it onto the internal support, then push the PUSH symbol fully in until it clicks into place;

i Please note:

If the infuser is difficult to insert, before insertion, adapt it to the right size by pressing the two levers (fig. 27).

- Once inserted, make sure the two coloured buttons have snapped out;
- Close the infuser door;
- Put the water tank back.

14.10 Cleaning the milk container

Clean the milk container (D) each time you prepare milk as described below:

- Remove the lid (D2);
- Remove the milk spout (D5) and intake tube (D4) (fig. 28);
- Turn the froth adjustment dial (D1) anticlockwise to the "INSERT" position (fig. 29) and pull off upwards;
- Wash all the components thoroughly with hot water and mild washing-up liquid. All components are dishwasher safe, placing them in the top basket of the dishwasher. Make sure there are no milk residues on the hollow and groove under the dial (fig. 30). If necessary, scrape the groove with a toothpick;
- Rinse inside the froth adjustment dial seat with running water (fig. 31);
- Check that the intake tube and milk spout are not clogged with milk residues;
- Replace the dial (in correspondence to the word "INSERT"), spout and milk intake tube;
- Place the lid back on the milk container (D3).

14.11 Cleaning the hot water nozzle

Each time you prepare milk, clean the connection nozzle (A8) with a sponge to remove milk residues from the gaskets (fig. 20).

15. DESCALING

! Important!

- Before use, read the instructions and the labelling on the descaler pack.
- You should use De'Longhi descaler only. Using unsuitable descaler and/or performing descaling incorrectly may result in faults not covered by the manufacturer's guarantee.

Descale the machine when "Descale, ESC to cancel, OK to descale (~45 minutes)" appears on the display (B1). To descale immediately, press **OK** (B3) and follow the instructions from point

6. To descale the appliance later, press **ESC** (B5). The  symbol on the display reminds you that the appliance needs descaling. To access the descaling menu:

- Turn the appliance on and wait until it is ready for use;
- Press  (B6) to enter the "Settings" menu;
- Press the selection arrows (B2 and B4) until "Maintenance" is displayed between the two lines. Press **OK** (B3);
- Press **OK** to select "Descale";
- Confirm? (~45 minutes): Press **OK** to confirm;
- "Remove filter": extract the water tank (A17), remove the water softener filter (C4) (if present) and empty the water tank. Press **OK**;
- "Pour descaler and water into tank": Pour the descaler into the tank up to level **A** (corresponding to a 100 ml pack) marked on the inner surface of the tank, then add water (1 litre) up to level **B** (fig. 32) and put the water tank back. Press **OK**;
- "Empty drip tray": Remove, empty and replace the drip tray (A15) and grounds container (A11). Press **OK**;
- "Place 1.8L container empty under spouts": Place an empty container with a minimum capacity of 1.8 litres under the hot water spout (C6) and coffee spouts (A9) (fig. 33). Press **OK**;

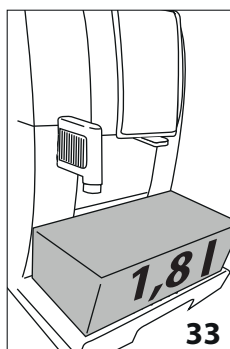

! Important! Danger of burns

Hot water containing acid flows out of the coffee spouts and hot water spout. Take care to avoid contact with splashes of this solution.

10. "Descaling underway": The descale programme starts and the descaler liquid comes out of the hot

water and coffee spouts. A series of rinses and pauses is performed automatically to remove all the scale residues inside the coffee machine;

After about 25 minutes, descaling stops;

- "Rinse tank and fill with water": the appliance is now ready to rinse with fresh water. Empty the container used to collect the descaler solution. Extract the water tank, empty, rinse under running water, fill with fresh water up to the MAX level and put back in the appliance. Press **OK**;
- "Place 1.8L container empty under spouts": place the container used to collect the descaler solution empty under the coffee spouts and hot water spout (fig. 33) and press **OK**;
- "Rinsing Confirm?": press **OK**;

11. "Rinsing underway": hot water is delivered first from the coffee spouts, then from the hot water spout;
12. When the water in the tank has run out, empty the container used to collect the rinsing water;
13. "Rinse tank and fill with water": extract the water tank and fill with fresh water up to the MAX level. Press **OK**;
14. "Insert filter": put the water softener filter (if removed) back in its housing in the water tank, and replace the tank in the appliance. Press **OK**;
15. "Place 1.8L container empty under spouts": place the container used to collect the descaler solution empty under the hot water spout. Press **OK**;
16. "Rinsing Confirm?": press **OK**.
17. "Rinsing underway". Hot water comes out of the hot water spout;
18. "Empty drip tray": At the end of the second rinse, remove, empty and replace the drip tray (A15) and grounds container (A11). Press **OK**;
19. "Descale complete": press **OK**;
20. "Fill tank": empty the container used to collect the rinse water, remove the water tank and fill with fresh water up to the MAX level, then put back in the appliance.

Descaling is complete.

i Please note!

- If the descaling cycle is not completed correctly (e.g. no electricity) we recommend repeating the cycle;
- After descaling, it is normal for the grounds container (A11) to contain water;
- If the water tank has not been filled to the MAX level, at the end of descaling, the appliance requests a third rinse to guarantee that the descaler solution has been completely eliminated from the machine's internal circuits.
- The appliance may request descaling cycles at very short intervals. This is normal and due to the appliance's advanced control system.

16. SETTING WATER HARDNESS

The descale message is displayed after a period of time established according to water hardness.

The machine is set by default for a hardness level of 4. The machine can also be programmed according to the hardness of the mains water in the various regions so that the machine needs to be descaled less often.

16.1 Measuring water hardness

1. Remove the "TOTAL HARDNESS TEST" indicator paper (C1) from its pack (attached to the English instructions);

2. Immerse the paper completely in a glass of water for one second;
3. Remove the paper from the water and shake lightly. After about a minute, 1, 2, 3, or 4 red squares form, depending on the hardness of the water. Each square corresponds to one level;

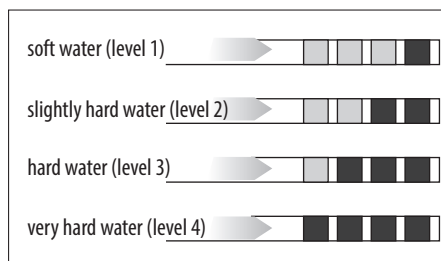

16.2 Setting water hardness

1. Press (B6) to enter the "Settings" menu;
2. Press the selection arrows (B2 and B4) until "General" is displayed between the two lines. Press **OK**;
3. Press the selection arrows until "Water hardness" is displayed, then press **OK**;
4. The current selection appears on the display and the new selection flashes. Press the selection arrows until the required new selection is displayed. Press **OK**.

The new level is saved and the appliance goes back to the "General" menu.

Press /ESC (B5) twice to go back to the main screen.

17. WATER SOFTENER FILTER

Certain models are fitted with a water softener filter (C4). If this is not the case with your model, you are recommended to purchase one from De'Longhi Customer Services.

To use the filter correctly, follow the instructions below.

17.1 Installing the filter

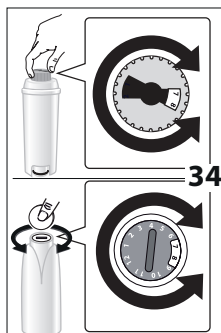

1. Remove the filter (C4) from the packaging. The date indicator disk varies according to the filter provided.
2. Turn the date indicator disk (fig. 34) until the next 2 months of use are displayed.

i Please note

The filter lasts about two months if the appliance is used normally.

If the coffee machine is left unused with the filter installed, it will last a maximum of three weeks.

3. To activate the filter, run tap water through the hole in the filter as shown in fig. 35 until water comes out of the openings at the side for more than a minute.;

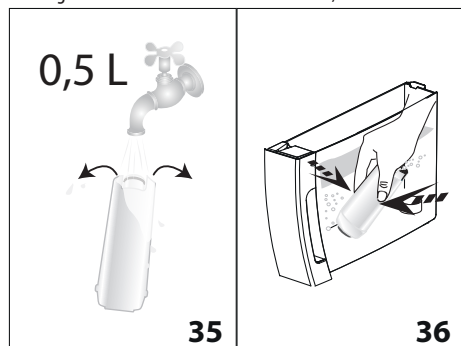

4. Extract the tank (A17) from the appliance and fill with water;
5. Insert the filter in the water tank and immerse it completely for about ten seconds, sloping it and pressing it lightly to enable the air bubbles to escape (fig. 36).
6. Insert the filter in the filter housing (A18) and press as far as it will go (fig. 37);
7. Close the tank with the lid (A16) (fig. 38), then replace the tank in the machine;

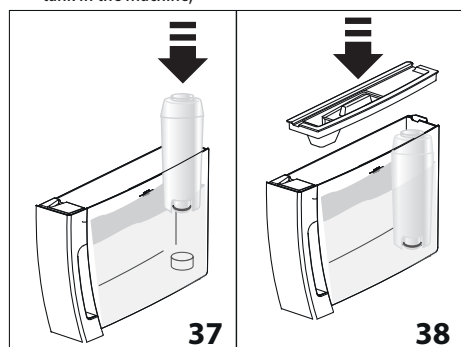

When you install the filter, you must notify the appliance of its presence.

8. Press (B6) to enter the "Settings" menu;
9. Press the selection arrows (B2 and B4) until "Maintenance" is displayed between the two lines. Press **OK**;
10. Press the selection arrows until "Install filter" is displayed, then press **OK**;
11. Confirm?": press **OK**;
12. "Hot water, Confirm?": Position a container under the hot water spout (C6) (min. capacity: 500 ml), then press **OK**;

13. The appliance begins hot water delivery and the message "Please wait" is displayed;
 14. After the flow of hot water stops, the appliance automatically resets to "Ready for coffee" status.
- The filter is now active and you can use the coffee machine.

17.2 Replacing the filter

Replace the filter (C4) when "Replace filter, ESC to cancel, OK to replace" appears on the display (B1). To replace immediately, press **OK** (B3) and follow the instructions from point 8. To replace later, press **ESC** (B5). The symbol on the display reminds you that the filter needs replacing.

To replace the filter, proceed as follows:

1. Extract the tank (A17) and exhausted filter;
2. Take the new filter out of its packet and proceed as illustrated in points 2, 3, 4, 5, 6 and 7 in the previous section;
3. Press (B6) to enter the "Settings" menu;
4. Press the selection arrows (B2 and B4) until "Maintenance" is displayed between the two lines. Press **OK**;
5. Press the selection arrows until "Replace filter" is displayed, then press **OK**;
6. Confirm?": press **OK**;
7. "Hot water, Confirm?": Position a container under the hot water spout (C6) (min. capacity: 500 ml), then press **OK**;
8. The appliance begins hot water delivery and the message "Please wait" is displayed;
9. After the flow of hot water stops, the appliance automatically resets to "Ready for coffee" status.

The new filter is now active and you can use the coffee machine.

Please note!

After two months (see date indicator) or when the appliance has not been used for 3 weeks, you should replace the filter even if the message has not yet been displayed.

17.3 Removing the filter

If you want to use the appliance without the filter (C4), you must remove it and notify the appliance of its removal. Proceed as follows:

1. Extract the tank (A17) and exhausted filter;
 2. Press (B6) to enter the "Settings" menu;
 3. Press the selection arrows (B2 and B4) until "Maintenance" is displayed between the two lines. Press **OK**;
 4. Press the selection arrows until "Remove filter" is displayed, then press **OK**;
 5. "Confirm?": press **OK** to confirm removal. The appliance goes back to the "Maintenance" menu;
- Press /ESC (B5) to exit the menu.

**Please note!**

After two months (see date indicator) or when the appliance has not been used for 3 weeks, you should replace the filter even if the message has not yet been displayed.

18. TECHNICAL DATA

Voltage:	220-240 V~ 50/60 Hz max. 10A
Absorbed power:	1450W
Pressure:	1.5MPa (15 bars)
Max. water tank capacity:	1.8 l
Size LxDxH:	240x440x360 mm
Cord length:	1750 mm
Weight:	9.9 kg
Max. beans container capacity:	300 g



This product complies with European regulation no. 1935/2004 on materials and articles intended to come into contact with food.



19. DISPOSING OF THE APPLIANCE

The appliance must not be disposed of with household waste, but taken to an authorised waste separation and recycling centre.

20. DISPLAYED MESSAGES

DISPLAYED MESSAGE	POSSIBLE CAUSE	REMEDY
Fill tank	Insufficient water in the tank (A17).	Fill the tank with water and/or insert it correctly, pushing it as far as it will go until it clicks into place (fig. 3B).
Insert tank	The tank (A17) is not correctly in place.	Insert the tank correctly and press as far as it will go (page 3B).
Empty grounds container	The grounds container (A11) is full.	Empty the grounds container and drip tray (A15), clean and replace. Important: when removing the drip tray, the grounds container MUST be emptied, even if it contains few grounds. If this is not done, when you make the next coffees, the grounds container may fill up more than expected and clog the machine.
Insert grounds container	After cleaning, the grounds container (A11) has not been replaced.	Remove the drip tray (A15) and insert the grounds container.
Add pre-ground coffee	The "pre-ground coffee" function has been selected without placing any pre-ground coffee in the funnel (A4).	Place pre-ground coffee in the funnel (fig. 11) or deselect the "pre-ground" function.
	A LONG coffee with pre-ground coffee has been requested	Put one level measure of pre-ground coffee into the pre-ground coffee funnel (A4) and press OK (B3) to continue and complete preparation.
Fill beans container	The coffee beans have run out.	Fill the beans container (A3) (fig. 8).
	The pre-ground coffee funnel (A4) is clogged.	Empty the funnel with the help of the brush (C5) as described in section "14.8 Cleaning the pre-ground coffee funnel".



Ground too fine Adjust mill	The grinding is too fine and the coffee is delivered too slowly or not at all.	Repeat coffee delivery and turn the grinding adjustment dial (A5) (fig. 7) one click clockwise towards 7 while the coffee mill is in operation. If after making at least 2 coffees delivery is still too slow, repeat the correction procedure, turning the grinding adjustment dial another click until delivery is correct (see section "10.1 Adjusting the coffee mill". If the problem persists, make sure the water tank (A17) is fully inserted.
	If the water softener filter (C4) is present, an air bubble may have been released inside the circuit, obstructing delivery.	Insert the hot water spout (C6) in the appliance and deliver a little water until the flow becomes regular.
Less coffee	Too much coffee has been used.	Select a lighter taste by pressing  (B7) or reduce the quantity of pre-ground coffee.
Insert water spout	The hot water spout (C6) is not inserted or is inserted incorrectly.	Fully insert the hot water spout (fig. 4).
Insert milk container	The milk container (D) is not inserted correctly.	Insert the milk container as far as it will go (fig. 16).
Insert infuser assembly	The infuser (A20) has not been replaced after cleaning.	Insert the infuser as described in section "14.9 Cleaning the infuser".
Water circuit empty Fill water circuit Hot water Confirm?	The water circuit is empty.	Press OK (B3) to deliver water from the spout (C6) until it flows out normally. If the problem persists, make sure the water tank (A17) is fully inserted.
Press OK to CLEAN	The milk container (D) has been inserted with the froth adjustment dial (D1) in the "CLEAN" position.	To proceed with the CLEAN function press OK or turn the froth adjustment dial to another position.
Set dial to CLEAN ESC to cancel	Milk has been delivered recently and the tubes inside the milk container (D) must be cleaned.	Turn the froth adjustment dial (D1) to CLEAN (fig. 19).
Turn froth adjustment dial	The milk container (D) has been inserted with the froth adjustment dial (D1) in the "CLEAN" position.	Turn the froth adjustment dial to one of the milk froth positions.
Descale ESC to cancel OK to descale (~45 minutes)	The machine must be descaled.	The descaling procedure described in section "15. Descaling" needs to be performed.
Replace filter ESC to cancel OK to replace	The water softener filter (C4) is exhausted.	Replace the filter or remove it as described in section "17. Water softener filter".
General alarm	The inside of the appliance is very dirty.	Clean the inside of the appliance thoroughly, as described in section "14. Cleaning". If the message is still displayed after cleaning, contact a service centre.

	The tubes inside the milk container (D) must be cleaned.	Turn the froth adjustment dial (D1) to CLEAN (fig. 19).
	The water softener filter (C4) is exhausted and must be replaced or removed.	Replace the filter or remove it as described in section "17. Water softener filter".
	The machine must be descaled.	The descaling procedure described in section "15. Descaling" needs to be performed. The appliance may request descaling cycles at very short intervals. This is normal and due to the appliance's advanced control system.
ECO	Energy saving is enabled.	To disable energy saving, proceed as described in section "8.5 General" - "•Energy saving:"

21. TROUBLESHOOTING

Below is a list of some of the possible malfunctions.

If the problem cannot be resolved as described, contact Customer Services.

PROBLEM	POSSIBLE CAUSE	REMEDY
The coffee is not hot.	The cups were not preheated.	Warm the cups by rinsing them with hot water (Please note: you can use the hot water function).
	The internal circuits of the appliance have cooled down because 2/3 minutes have elapsed since the last coffee was made.	Before making coffee, rinse the internal circuits by pressing the  button (B5).
	A low coffee temperature is set.	Set a higher coffee temperature in the menu.
The coffee is weak or not creamy enough.	The coffee is ground too coarsely.	Turn the grinding adjustment dial (A5) one click anticlockwise towards 1 while the coffee mill is in operation (fig. 7). Continue one click at a time until coffee delivery is satisfactory. The effect is only visible after delivering 2 coffees (see section "10.1 Adjusting the coffee mill").
	The coffee is unsuitable.	Use pre-ground coffee for espresso machines.
The coffee is delivered too slowly or a drop at a time.	The coffee is ground too finely.	Turn the grinding adjustment dial (A5) one click clockwise towards 7 while the coffee mill is in operation (fig. 7). Continue one click at a time until coffee delivery is satisfactory. The effect is only visible after delivering 2 coffees (see section "10.1 Adjusting the coffee mill").
The appliance will not make coffee	The appliance has detected impurities in its internal circuits. "Please wait" is displayed.	Wait for the appliance to be ready for use again and reselect the required beverage. Contact Customer Services if the problem persists.
Coffee does not come out of one or both of the spouts.	The coffee spouts (A9) are blocked.	Clean the spouts with a toothpick (fig. 24B).
The appliance does not come on	It is not plugged into the mains socket.	Plug into the mains socket (fig. 1).
	The main switch (A22) is not turned on.	Place the main switch in the I position (fig. 2).
	The power cord (C7) connector is not inserted correctly.	Insert the connector as far as it will go in the socket at the back of the appliance (fig. 1).
The infuser cannot be extracted	The appliance has not been turned off correctly	Turn the appliance off by pressing the  button (A7) (fig. 6) (see section "7. Turning the appliance off").

At the end of descaling, the appliance requests a third rinse	During the two rinse cycles, the water tank has not been filled to the MAX level.	Follow the instructions displayed by the appliance, but first empty the drip tray to avoid the water overflowing.
The milk does not come out of the milk spout (D5)	The lid (D2) of the milk container lid is dirty	Clean the milk container lid as described in the section "15. Descaling".
The milk contains large bubbles and squirts out of the milk spout (D5) or there is little froth	The milk is not cold enough or is not semi-skimmed.	Use skimmed or semi-skimmed milk at refrigerator temperature (about 5° C). If the result is not as you wished, try changing brand of milk.
	The froth adjustment dial (D1) is incorrectly adjusted.	Adjust following the instructions in section "• Espresso macchiato;"
	The milk container lid (D2) or froth adjustment dial (D1) is dirty	Clean the milk container lid and dial as described in section "15. Descaling".
	The hot water connection nozzle (A8) is dirty	Clean the connection nozzle as described in section . "14.11 Cleaning the hot water nozzle".

22. ELECTRICAL REQUIREMENTS

Before using this appliance ensure that the voltage indicated on the product corresponds with the main voltage in your home, if you are in any doubt about your supply contact your local electricity company.

The flexible mains lead is supplied connected to a B.S. 1363 fused plug having a fuse of 13 amp capacity.

Should this plug not fit the socket outlets in your home, it should be cut off and replaced with a suitable plug, following the procedure outlined below.

Note: Such a plug cannot be used for any other appliance and should therefore be properly disposed of and not left where children might find it and plug it into a supply socket - with the obvious consequent danger.

Please note: We recommend the use of good quality plugs and wall sockets that can be switched off when the machine is not in use.

IMPORTANT: The wires in the mains lead fitted to this appliance are coloured in accordance with the following code:

GREEN AND YELLOW
BLUE
BROWN

EARTH
NEUTRAL
LIVE

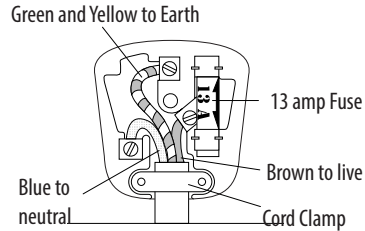

As the colours of the wires in the mains lead of this appliance may not correspond with the coloured markings identifying the terminals in your plug, proceed as follows:

- The wire which is coloured green and yellow must be connected to the terminal in the plug which is marked with the letter E or by the earth symbol  or coloured green or green and yellow.
- The wire which is coloured blue must be connected to the terminal which is marked with the letter N or coloured black.
- The wire which is coloured brown must be connected to the terminal which is marked with the letter L or coloured red.

When wiring the plug, ensure that all strands of wire are securely retained in each terminal. Do not forget to tighten the mains lead clamp on the plug. If your electricity supply point has only two pin socket outlets, or if you are in doubt, consult a qualified electrician.

Should the mains lead ever require replacement, it is essential that this operation be carried out by a qualified electrician and should only be replaced with a flexible cord of the same size.

After replacement of a fuse in the plug, the fuse cover must be refitted. If the fuse cover is lost, the plug must not be used until a replacement cover is obtained. The colour of the correct replacement fuse cover is that of the coloured insert in the base of the fuse recess or elsewhere on the plug. Always state this colour when ordering a replacement fuse cover.

Only 13amp replacement fuses which are asta approved to B.S. 1362 should be fitted.

This appliance conforms to the Norms EN 55014 regarding the suppression of radio interference.

Warning - this appliance must be earthed