

## CONTENTS

<b>1. INTRODUCTION</b> .....	<b>7</b>
1.1 Letters in brackets .....	7
1.2 Troubleshooting and repairs .....	7
1.3 Download the App! .....	7
<b>2. DESCRIPTION</b> .....	<b>7</b>
2.1 Description of the appliance (page 3 - A) .....	7
2.2 Description of the homepage (page 2 - B) .....	7
2.3 Description of the control panel (page 2 - C) .....	7
2.4 Description of the accessories (page 2 - D) .....	8
2.5 Description of the milk container (page 2 - E) .....	8
<b>3. SETTING UP THE APPLIANCE</b> .....	<b>8</b>
<b>4. TURNING THE APPLIANCE ON</b> .....	<b>8</b>
<b>5. TURNING THE APPLIANCE OFF</b> .....	<b>8</b>
<b>6. MENU SETTINGS</b> .....	<b>9</b>
6.1 Access the settings menu .....	9
6.2 Exit the menu .....	9
6.3 Rinse .....	9
6.4 Descaling .....	9
6.5 Water filter .....	9
6.6 Beverages settings .....	9
6.7 Auto-off (standby) .....	9
6.8 Energy saving .....	9
6.9 Coffee temperature .....	9
6.10 Water hardness .....	9
6.11 Set language .....	9
6.12 Beep .....	10
6.13 Bluetooth .....	10
6.14 Default values .....	10
6.15 Statistics .....	10
6.16 Customise profile .....	10
<b>7. MAKING COFFEE</b> .....	<b>10</b>
7.1 Making coffee using coffee beans .....	10
7.2 Selecting the coffee aroma .....	10
7.3 Selecting the coffee quantity .....	11
7.4 Making coffee using pre-ground coffee .....	11
7.5 Adjusting the coffee mill .....	11
7.6 Tips for a hotter coffee .....	11
<b>8. MAKING CAPPUCCINOS AND MILK-BASED COFFEES</b> .....	<b>11</b>
8.1 Filling and attaching the milk container .....	12
8.2 Adjusting the amount of froth .....	12
8.3 Making cappuccinos and milk-based coffees automatically .....	12
8.4 Cleaning the milk container after use .....	12
<b>9. COFFEE CARAFE</b> .....	<b>13</b>
<b>10. DELIVERING HOT WATER</b> .....	<b>13</b>
<b>11. CUSTOMISING THE BEVERAGES</b> .....	<b>13</b>
<b>12. MEMORISING YOUR OWN USER PROFILE</b> .....	<b>14</b>
<b>13. CLEANING</b> .....	<b>14</b>
13.1 Cleaning the machine .....	14
13.2 Cleaning the internal circuit .....	14
13.3 Cleaning the coffee grounds container .....	14
13.4 Cleaning the drip tray and condensate tray .....	14
13.5 Cleaning the inside of the coffee machine .....	15
13.6 Cleaning the water tank .....	15
13.7 Cleaning the coffee spouts .....	15
13.8 Cleaning the pre-ground coffee funnel .....	15
13.9 Cleaning the infuser .....	15
13.10 Cleaning the milk container .....	15
13.11 Cleaning the hot water nozzle .....	16
<b>14. DESCALING</b> .....	<b>16</b>
<b>15. SETTING WATER HARDNESS</b> .....	<b>17</b>
15.1 Measuring water hardness .....	17
15.2 Setting water hardness .....	17
<b>16. WATER SOFTENER FILTER</b> .....	<b>17</b>
16.1 Installing the filter .....	17
16.2 Replacing the filter .....	18
16.3 Removing the filter .....	18
<b>17. TECHNICAL DATA</b> .....	<b>18</b>
<b>18. DISPLAYED MESSAGES</b> .....	<b>19</b>
<b>19. TROUBLESHOOTING</b> .....	<b>24</b>

## 1. INTRODUCTION

Thank you for choosing this bean to cup espresso and cappuccino machine.

Take a few minutes to read this Instruction for Use. This will avoid all risks and damage to the appliance.

### 1.1 Letters in brackets

The letters in brackets refer to the legend in the description of the appliance on pages 2-3.

### 1.2 Troubleshooting and repairs

In the event of problems, first try and resolve them by reading the information given in sections "18. Displayed messages" and "19. Troubleshooting".

If this does not resolve the problem or you require further information, you should consult Customer Services by calling the number given on the annexed "Customer Service" sheet.

If your country is not among those listed on the sheet, call the number given in the guarantee. If repairs are required, contact De'Longhi Customer Services only. The addresses are given in the guarantee certificate provided with the machine.

### 1.3 Download the App!



A number of functions can be controlled remotely using the De'Longhi Coffee Link App.

In the App, you can also find information, tips and curious facts about the world of coffee, together with information on your machine at your fingertips.



This symbol highlights the functions you can control or consult using the App.

You can also create up to 3 new beverages and save them in your appliance.

#### **Please note:**

Check compatible devices on "compatibledevices.delonghi.com".

## 2. DESCRIPTION







### 2.1 Description of the appliance (page 3 - A)

- A1. Beans container lid
- A2. Pre-ground coffee funnel lid
- A3. Beans container
- A4. Pre-ground coffee funnel
- A5. Grinding adjustment dial
- A6. Cup shelf
- A7.  button: to turn the appliance on and off (standby)
- A8. Hot water connection nozzle
- A9. Coffee spouts (adjustable height)
- A10. Condensate tray
- A11. Coffee grounds container
- A12. Cup tray
- A13. Drip tray water level indicator
- A14. Drip tray grille
- A15. Drip tray
- A16. Water tank lid
- A17. Water tank
- A18. Water softener filter housing
- A19. Infuser door
- A20. Infuser
- A21. Power cord connector socket
- A22. Main switch

### 2.2 Description of the homepage (page 2 - B)

- B1. Bluetooth active symbol
- B2. Energy Saving active symbol
- B3. Selected aroma
- B4. Directly selected beverages
- B5. Scroll arrow
- B6. Quantity selected
- B7. Descale required alarm
- B8. Milk container needs cleaning alarm
- B9. Filter needs replacing alarm

### 2.3 Description of the control panel (page 2 - C)

- C1.  : beverage quantity selection
- C2.  : profile selection
- C3.  : appliance settings menu
- C4.  : press to exit from the selected function and go back to the main menu
- C5.  : My beverages selection menu. Unless previously programmed from the settings menu as described in chapter "11. Customising the beverages ", the beverage is programmed directly the first time you use the appliance
- C6.  : beverage aroma selection

## 2.4 Description of the accessories (page 2 - D)

- D1. "Total Hardness Test" indicator paper (attached to page 2 of the English instructions)
- D2. Pre-ground coffee measure
- D3. Descaler
- D4. Water softener filter (certain models only)
- D5. Cleaning brush
- D6. Hot water spout
- D7. Power cord

## 2.5 Description of the milk container (page 2 - E)

- E1. Froth adjustment and CLEAN dial
- E2. Milk container lid
- E3. Milk container
- E4. Milk intake tube
- E5. Frothed milk spout (adjustable)

## 3. SETTING UP THE APPLIANCE

### **Please note!**

- The first time you use the machine, the water circuit is empty and the appliance could be very noisy. The noise becomes less as the circuit fills.
- Coffee has been used to factory test the appliance and it is therefore completely normal for there to be traces of coffee in the mill. The machine is, however, guaranteed to be new.
- You should customise water hardness as soon as possible following the instructions in section "15. Setting water hardness".

1. Insert the power cable connector (D7) into the socket (A21) at the back of the appliance and connect the appliance to the mains electricity supply (fig. 1). Make sure the main switch (A22) at the back of the appliance is pressed (fig. 2);
2. "SELECT LANGUAGE": Press and hold  until the required language appears on the display, then press the flag corresponding to the language.

Follow the instructions indicated on the appliance display:

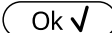
3. "FILL TANK WITH" "FRESH WATER": remove the water tank (A17) (fig. 3), fill to the MAX line (marked on the tank) with fresh water (fig. 4, then put the tank back in the appliance (fig. 5);
4. "INSERT WATER SPOUT": Check that the hot water spout (D6) is inserted on the connection nozzle (A8) (fig. 6) and place a container holding a minimum of 100 ml underneath (fig. 7);
5. "WATER CIRCUIT EMPTY" "PRESS OK TO START": press  to confirm. The appliance delivers hot water from the spout (fig. 8) then goes off automatically.

The coffee machine is now ready for normal use.

### **Please note!**

- The first time you use the appliance, you need to make 4-5 cappuccinos before it starts to give satisfactory results.
- When making the first 5-6 cappuccinos, it is normal to hear the noise of boiling water. After this, the noise becomes less.
- To improve the performance of your appliance, we recommend installing a water softener filter (D7) as described in section "16. Water softener filter". If your model is not provided with a filter, you can request one from De'Longhi Customer Services.

## 4. TURNING THE APPLIANCE ON

### **Please note!**

Before turning the appliance on, make sure the main switch (A22) is pressed (fig. 2).

Each time the appliance is turned on, it performs an automatic preheat and rinse cycle.

- To turn the appliance on, press the  button (A15) (fig. 8). The message "HEATING UP UNDERWAY" "PLEASE WAIT" appears on the display.
- When heating is complete, the message changes to: "RINSING UNDERWAY" "PLEASE WAIT". As well as heating the boiler, this also heats the internal circuits by circulating hot water.

The appliance is ready for use when the main screen (home-page) appears.

## 5. TURNING THE APPLIANCE OFF

Whenever the coffee machine is turned off after being used to make coffee, it performs an automatic rinse cycle.

- To turn the appliance off, press the  button (A15) (fig. 8).
- The message "TURNING OFF UNDERWAY" "PLEASE WAIT" appears on the display, then (if envisaged) the appliance performs a rinse cycle and goes off (standby).

### **Please note!**

If you will not be using the appliance for some time, unplug from the mains socket:



- first turn the appliance off by pressing the  button (fig. 8);
- release the main switch (A22) at the back of the appliance (fig. 2).

### **Important!**

Never press the main switch while the appliance is on.

## 6. MENU SETTINGS

### 6.1 Access the settings menu

1. Press the  button (C3) to enter the menu;
2. Scroll through the menu items by pressing  until the required items is displayed;
3. Press the menu item you want to select.

### 6.2 Exit the menu

When you have made the adjustments, press  until you are back on the homepage.

### 6.3 Rinse

Use this function to deliver hot water from the coffee spouts (A9) and hot water spout (D6), if inserted, to clean and heat the appliance's internal circuit.

1. Place a container with a minimum capacity of 100ml under the coffee and hot water spouts (fig. 8).
2. A few seconds after the "RINSING" item has been selected, hot water is delivered first from the coffee spouts and then from the hot water spout (if inserted) which cleans and heats the appliance's internal circuit (fig. 7).
3. To stop rinsing, press  or wait for rinsing to stop automatically.

#### *Please note!*

- If the appliance is not used for more than 3-4 days, when you turn it on again, we strongly recommend performing 2/3 rinses before use;
- After cleaning, it is normal for the grounds container (A11) to contain water.

### 6.4 Descaling





For instructions on descaling, see section "14. Descaling".



### 6.5 Water filter

For instructions on how to install the filter (D7), see section "16. Water softener filter".

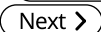
### 6.6 Beverages settings

In this section, you can consult your customised settings and, if you wish, reset the default values for each beverage and each profile.

1. Once in the settings menu, press "DRINK SETTINGS". The values for the first beverage appear on the display;
2. The values are displayed on vertical bars. The default value is indicated by the  symbol, while the current value is highlighted by the solid part of the vertical bar;
3. To go back to the settings menu, press . To scroll and display the beverages, press ;
4. To reset the default values for the beverage displayed, press ;

5. "CONFIRM RESET?": to confirm, press  (to cancel, press );

6. "VALORI FABBRICA""IMPOSTATI": press .

The beverage has been reset to the default values. Proceed with the other beverages or go back to the homepage by pressing  twice.



#### *Please note!*

To change the beverages in another profile, go back to the homepage, select the required profile and repeat the procedure.

### 6.7 Auto-off (standby)

Auto-off can be set so that the appliance goes off after 15 or 30 minutes, or 1, 2 or 3 hours.

To programme Auto-off, proceed as follows:



1. Press "AUTO-OFF";
2. Select the required time interval by pressing the selection arrows  (increase) or  (decrease);
3. To confirm, press .

Auto-off is programmed.

### 6.8 Energy saving

Use this function to enable or disable energy saving. When enabled, the function reduces energy consumption in compliance with European regulations.

To disable or enable "Energy Saving", proceed as follows:

1. Press "ENERGY SAVING" to disable  or enable  the function;

The corresponding symbol (B2) appears on the top bar of the homepage to indicate that the function has been enabled.

#### *Please note:*

If "Energy Saving" is active, you may have to wait a few seconds before delivery.

### 6.9 Coffee temperature

To modify the temperature of the water used to make the coffee, proceed as follows:

1. Press "COFFEE TEMPERATURE". The selectable values appear on the display (B1) (the current value is underlined);
2. Press the value you want to set (LOW, MEDIUM, HIGH, MAXIMUM).

### 6.10 Water hardness

For instructions on setting water hardness, see section "15. Setting water hardness".

### 6.11 Set language



To modify the language of the display, proceed as follows:

1. Press "SET LANGUAGE";

- Press the flag corresponding to the language you want to set (press **Next >** to display all the languages available).



### 6.12 Beep

This enables or disables the beep emitted by the machine each time an icon is pressed or an accessory is inserted/removed. To disable or enable the beep, proceed as follows:

- Press "BEEP" to disable  or enable  the function;

### 6.13 Bluetooth

This function enables or disables the protection PIN to connect to the appliance from a device.

- Press "BLUETOOTH". The serial number of the machine (19 digits) and a 4 digit number (PIN) appear on the display (B1);
- Press  to enable or  to disable the request for the PIN when you connect via the App;

The preset PIN is "0000". You are recommended to customise the PIN directly from the APP.

#### **Please note!**

The serial number of the appliance, visible in the "Bluetooth" function, enables it to be identified unambiguously when an association is created with the APP.

### 6.14 Default values

This resets all menu settings and programmed quantities for all profiles back to the default values (with the exception of the language which remains as set).

To reset the default values, proceed as follows:

- Press "DEFAULT VALUES". "DEFAULT VALUES" is displayed. Press **Ok ✓** to confirm (or press **Esc ↵** to cancel the operation);
- "DEFAULT VALUES SET": press **Ok ✓** to confirm.

### 6.15 Statistics

This displays statistics relating to the machine. To view the statistics, proceed as follows:

- Press "STATISTICS" and check all the statistics by scrolling through the items using **Next >**.

### 6.16 Customise profile

To customise the icon of the current profile, proceed as follows:

- Press "CUSTOMISE PROFILE";
- Press the desired icon. On the homepage, the top band is displayed with the colour of the icon.

## 7. MAKING COFFEE

### 7.1 Making coffee using coffee beans

#### **Important!**

Do not use green, caramelised or candied coffee beans as they could stick to the coffee mill and make it unusable.

- Fill the container (A4) with coffee beans (fig. 10);
- Place a cup under the coffee spouts (A9);
- Lower the spouts as near as possible to the cup (fig. 11). This makes a creamier coffee;
- Then select your required coffee:
  - ESPRESSO
  - LONG
  - COFFEE
  - DOPPIO+
  - 2X ESPRESSO
- Preparation begins. An image of the selected beverage appears on the display, together with a progress bar which gradually fills as preparation proceeds.

#### **Please note:**

- You can prepare 2 cups of ESPRESSO coffee at the same time by pressing "2X  " during preparation of 1 ESPRESSO (the image is displayed for a few seconds at the start of preparation).
- While the machine is making coffee, delivery can be interrupted at any moment by pressing **Stop X**.

Once the coffee has been delivered, the machine will be ready for further use.

#### **Please note!**

- Various alarm messages could be displayed while using the appliance (FILL TANK, EMPTY GROUNDS CONTAINER, ETC.). Their meaning is explained in section "18. Displayed messages".
- For hotter coffee, see section "7.6 Tips for a hotter coffee".
- If the coffee is delivered a drop at a time, too weak and not creamy enough or too cold, read the tips in sections "7.5 Adjusting the coffee mill" and "19. Troubleshooting".
- Preparation of each coffee can be customised (see sections "11. Customising the beverages" and "12. Memorising your own user profile").

### 7.2 Selecting the coffee aroma

Press the  button (C6):

	Custom (if programmed) / Standard
	EXTRA LIGHT

	LIGHT
	MEDIUM
	STRONG
	X-STRONG
	(see "7.4 Making coffee using pre-ground coffee")

After delivering the beverage, the aroma setting is reset to the **my** value.

### 7.3 Selecting the coffee quantity

Press the button (C1):

	Custom (if programmed) / Standard
	SMALL SIZE
	MEDIUM SIZE
	LARGE SIZE
	EXTRA-LARGE SIZE

After delivering the beverage, the quantity setting is reset to the **my** value

### 7.4 Making coffee using pre-ground coffee

#### **Important!**

- Never add pre-ground coffee when the machine is off or it could spread through the inside of the machine and dirty it. This could damage the machine.
  - Never use more than 1 level measure (D2) as it could soil the inside of the coffee machine or block the funnel (A4).
  - When using pre-ground coffee, only one cup can be made at a time.
1. Press the button (C6) until "☞" (ground) is displayed.
  2. Open the pre-ground coffee funnel lid (A2).
  3. Make sure the funnel(A4) is not blocked, then add one level measure of pre-ground coffee (fig. 12).
  4. Place a cup under the coffee spouts (A9).
  5. Then select your required coffee:
    - ESPRESSO
    - LONG
    - COFFEE

6. Preparation begins. An image of the selected beverage appears on the display, together with a progress bar which gradually fills as preparation proceeds.

Once the coffee has been delivered, the machine will be ready for further use.

#### **Important! Making LONG coffee:**

Halfway through preparation, the message "ADD GROUND COFFEE" "MAX. ONE MEASURE" is displayed. Add one level measure of pre-ground coffee and press .

### 7.5 Adjusting the coffee mill

The coffee mill is set by default to prepare coffee correctly and should not require regulating initially.

However, if after making the first few coffees you find that the coffee is either too weak and not creamy enough or delivery is too slow (a drop at a time), this can be corrected by adjusting the grinding adjustment dial (A5) (fig. 13).

#### **Please note!**

The grinding adjustment dial must only be turned when the coffee mill is in operation during the initial phase of coffee preparation.



If the coffee is delivered too slowly or not at all, turn one click clockwise towards 7. For fuller bodied creamier coffee, turn one click anticlockwise towards 1 (do not turn more than one click at a time otherwise the coffee could be delivered

a drop at a time).

These adjustments will only be evident after at least 2 cups of coffee have been delivered. If this adjustment does not produce the desired result, turn the dial another click.

### 7.6 Tips for a hotter coffee

For hotter coffee, proceed as follows:

- perform a rinse cycle by selecting the "Rinsing" function in the settings menu (section "6.3 Rinse ");
- warm the cups with hot water using the hot water function (see section "10. Delivering hot water");
- increase the coffee temperature in the settings menu "⚙️"(C3) (see section "6.9 Coffee temperature ").

## 8. MAKING CAPPUCCINOS AND MILK-BASED COFFEES

#### **Please note!**

To avoid milk with poor froth or large bubbles, always clean the milk container lid (E2) and hot water connection nozzle (A8) as described in sections "8.4 Cleaning the milk container after use", "13.10 Cleaning the milk container" and "13.11 Cleaning the hot water nozzle".

## 8.1 Filling and attaching the milk container



1. Remove the lid (E2) (fig. 14);
2. Fill the milk container (E3) with a sufficient quantity of milk, not exceeding the MAX level marked on the container (fig. 15). Each mark on the side of the container corresponds to about 100 ml of milk;

### Please note!

- For a denser more even froth, you must use skimmed or partially skimmed milk at refrigerator temperature (about 5°C).
  - If "Energy Saving" mode is enabled, you may have to wait a few seconds before the beverage is delivered.
3. Make sure the milk intake tube (E4) is correctly inserted in the bottom of the milk container lid (fig. 16);
  4. Place the lid back on the milk container;
  5. Remove the hot water spout (D6);
  6. Attach the milk container (E) to the connection nozzle (A8) and push as far as it will go (fig. 17). The machine emits a beep (if the beep function is enabled);
  7. Place a sufficiently large cup under the coffee spouts (A9) and the frothed milk spout (E5). Adjust the length of the milk spout. To move it nearer the cup, simply pull it downwards (fig. 18).
  8. Follow the instructions below for each function.

## 8.2 Adjusting the amount of froth

Turn the froth adjustment dial (E1) to adjust the amount of froth on the milk delivered while making cappuccinos and milk-based coffees.

Dial position	Description	Recommended for. . .
	NO FROTH	HOT MILK (not frothed) / CAFFELATTE
	MIN. FROTH	latte macchiato/ FLAT WHITE
	MAX. FROTH	CAPPUCCINO / CAPPUCCINO+ / CAPPUCCINO MIX / ESPRESSO MACCHIATO / HOT MILK (frothed)

## 8.3 Making cappuccinos and milk-based coffees automatically

1. Fill the milk container (E) and attach it as described above.
2. Select the required beverage:
  - CAPPUCCINO
  - LATTE MACCHIATO
  - HOT MILK
  - CAPPUCCINO+

- CAPPUCCINO MIX
- CAFFELATTE
- FLAT WHITE
- ESPRESSO MACCHIATO

3. A message on the display instructs you to turn the froth adjustment dial (E1) according to the froth required by the original recipe. Turn the dial on the milk container lid.
4. After a few seconds, preparation begins automatically and an image of the selected beverage appears on the display, together with a progress bar which gradually fills as preparation progresses.

Once the coffee has been delivered, the machine will be ready for further use.

### Please note: general indications when preparing all milk-based beverages

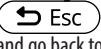
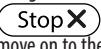
-  Esc: press to interrupt preparation completely and go back to the homepage.
-  Stop X: press to interrupt milk or coffee delivery and move on to the next delivery (if applicable) to complete the beverage.
- Preparation of each coffee can be customised (see sections "11. Customising the beverages " and "12. Memorising your own user profile").
- Do not leave the milk container out of the refrigerator for long periods. The warmer the milk (5°C is ideal), the poorer the quality of froth produced.

## 8.4 Cleaning the milk container after use

Each time you use a milk function, "TURN MILK FROTH ADJUSTMENT DIAL" "TO CLEAN POSITION" appears on the display and the milk frother lid must be cleaned:

1. Leave the milk container (E) in the machine (you do not need to empty it);
2. Place a cup or other recipient under the frothed milk spout;
3. Turn the froth adjustment dial (E1) to "CLEAN" (fig. 19). "CLEANING UNDERWAY" "RECIPIENT UNDER SPOUT" appears on the display together with a bar which gradually fills as cleaning progresses (fig. 20). Steam mixed with hot water comes out of the frothed milk spout. Cleaning stops automatically;
4. Turn the dial back to one of the froth selections;
5. Remove the milk container and always clean the hot water connection nozzle (A8) with a sponge (fig. 21).

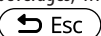

### Please note!

- To prepare a number of cappuccinos and milk based coffees, clean the milk container after you have prepared the last beverage only. To proceed with making the next beverages, when the CLEAN message is displayed, press .

- If you do not clean the milk container, the  symbol appears on the display to remind you that it needs cleaning.
- The milk container can be kept in the refrigerator.
- In some cases, to clean you must wait for the appliance to heat up.

## 9. COFFEE CARAFE

1. Position a carafe under the coffee spouts (A9). When choosing the carafe to use, bear in mind the quantity to be delivered, namely:

Selected quantity	Quantity (ml)
	250
	500
	750

2. Press "COFFEE POT", "SELECT AROMA" "AND NUMBER OF CUPS";
3. Press .
4. After a few seconds, preparation begins automatically and an image of the selected beverage appears on the display, together with a progress bar which gradually fills as preparation progresses.

Once the coffee has been delivered, the machine will be ready for further use.

### Please note:

-  **Esc**: press to interrupt preparation completely and go back to the homepage.

## SAFETY WARNING:

After making the pot of coffee, leave the appliance to cool for 5 minutes before making another beverage. Risk of overheating!

## 10. DELIVERING HOT WATER

1. Make sure the hot water spout (D6) is attached correctly to the hot water connection nozzle(A8);
2. Place a container under the spout (as close as possible to avoid splashes);
3. Press "HOT WATER";The corresponding image appears on the display, together with a progress bar which fills gradually as preparation proceeds;
4. The machine delivers hot water, then delivery stops automatically. To interrupt hot water delivery manually, press

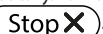





.

### Please note!

- If "Energy Saving" mode is active, you may have to wait a few seconds before the hot water is delivered.
- Preparation of hot water can be customised (see sections "11. Customising the beverages" and "12. Memorising your own user profile").

## 11. CUSTOMISING THE BEVERAGES



The aroma (when required) and quantity of the beverages can be customised.

1. Make sure the user profile for which you want to customise the beverage is active. You can select "MY" beverages for each of the profiles;
2. Press  (C5);
3. To access the customising screen, choose the beverage you want to customise. The corresponding accessories must be inserted;
4. (Beverages including coffee only) "CHOOSE COFFEE AROMA": Select the required aroma by pressing "-" or "+" and press .
5. "COFFEE QUANTITY" "STOP TO SAVE": Preparation begins and the appliance displays the quantity customising screen in the form of a vertical bar. The star alongside the bar represents the current quantity;
6. When the amount reaches the minimum quantity you can set,  is displayed;
7. Press  when the required quantity in the cup is reached;
8. "SAVE NEW SETTINGS?": Press  to save (or  to cancel).

The appliance confirms if the values have been saved or not (depending on the previous selection). Press .

The appliance goes back to the homepage.

### Please note!

- **Cappuccinos and milk-based coffees:** the coffee aroma is saved first, followed by the quantity of first milk, then coffee;
- **Hot water:** the appliance delivers hot water. Press  to save the required quantity.
- You can also customise the beverages by connecting with the DeLonghi Coffee Link App.
- Press  to exit programming. The values will not be saved.

Beverage quantity table		
Beverage	Standard quantity	Programmable quantity



<b>ESPRESSO</b>	40 ml	20-180 ml
<b>LONG</b>	160 ml	115-250 ml
<b>COFFEE</b>	180 ml	100-240 ml
<b>DOPPIO+</b>	120 ml	80-180 ml
<b>HOT WATER</b>	250 ml	20-420 ml

## 12. MEMORISING YOUR OWN USER PROFILE

The appliance allows you to memorise 3 different profiles, each associated with a different icon.

The customised "MY" beverages "AROMA" and "QUANTITY" values are saved in each profile (see section "11. Customising the beverages"). The order in which all the beverages are displayed is based on the frequency of selection.

To select a profile, press  and select the desired profile.

### **Please note!**

- " GUEST" profile: select this profile to deliver beverages with the default settings.
- You can rename your personal profile by connecting with the DeLonghi Coffee Link App (only the first three characters will be displayed).
- To customise the profile icon, see section "6.16 Customise profile".

## 13. CLEANING

### 13.1 Cleaning the machine

The following parts of the machine must be cleaned regularly:

- the appliance's internal circuit;
- coffee grounds container (A11);
- drip tray (A15), condensate tray (A10), drip tray grille (A14) and tray full indicator (A13);
- water tank (A17);
- coffee spouts (A9);
- pre-ground coffee funnel (A4);
- infuser (A20), accessible after opening the infuser door (A19);
- milk container (E);
- hot water connection nozzle (A8);
- touch screen (B).

### **Important!**

- Do not use solvents, abrasive detergents or alcohol to clean the coffee machine. With De'Longhi superautomatic coffee machines, no chemical products are required for cleaning purposes.

- None of the components of the appliance can be washed in a dishwasher with the exception of the drip tray grille (A14) and milk container (E).
- Do not use metal objects to remove encrustations or coffee deposits as they could scratch metal or plastic surfaces.

### 13.2 Cleaning the internal circuit

If the appliance is not used for more than 3/4 days, before using it again, we strongly recommend switching it on and:

- performing 2/3 rinse cycles by selecting the "Rinse" function (section "6.3 Rinse ");
- delivering hot water for a few seconds (section "10. Delivering hot water").

### **Please note!**

After cleaning, it is normal for the grounds container (A11) to contain water.

### 13.3 Cleaning the coffee grounds container

When "EMPTY GROUNDS CONTAINER" appears on the display, the grounds container must be emptied and cleaned. The appliance cannot be used to make coffee until you have cleaned the grounds container (A11). Even if not full, the empty grounds container message is displayed 72 hours after the first coffee has been prepared. For the 72 hours to be calculated correctly, the machine must never be turned off with the main switch (A22).

### **Important! Danger of scalding**

If you make a number of cappuccinos one after the other, the metal cup tray (A12) becomes hot. Wait for it to cool down before touching it and handle it from the front only.

To clean (with the machine on):

1. Remove the drip tray (A15) (fig. 22), empty and clean.
2. Empty the grounds container (A11) and clean thoroughly to remove all residues left on the bottom. This can be done using the spatula on the brush (D5) provided.
3. Check the condensate tray (A10) (red) and empty if necessary.

### **Important!**

When removing the drip tray, the grounds container must be emptied, even if it contains few grounds. If this is not done, when you make the next coffees, the grounds container may fill up more than expected and clog the machine.

### 13.4 Cleaning the drip tray and condensate tray

### **Important!**

The drip tray (A15) is fitted with a level indicator (A13) (red) showing the amount of water it contains (fig. 23). Before the indicator protrudes from the cup tray (A12), the drip tray must be emptied and cleaned, otherwise the water may overflow the edge and damage the appliance, the surface it rests on or the surrounding area.

To remove the drip tray, proceed as follows:

1. Remove the drip tray and coffee grounds container (A11) (fig. 22);
2. Remove the cup tray (A12) and drip tray grille (A14), then empty the drip tray and grounds container and wash all components.
3. Check the condensate tray (A15) (red) and empty if necessary;
4. Put the drip tray complete with grille and grounds container back in the appliance.

### 13.5 Cleaning the inside of the coffee machine

#### **Danger of electric shock!**

Before cleaning internal parts, the machine must be turned off (see section "5. Turning the appliance off") and unplugged from the mains power supply. Never immerse the machine in water.

1. Check regularly (about once a month) that the inside of the appliance (accessible after removing the drip tray (A15)) is not dirty. If necessary, remove coffee deposits with the brush (D5) supplied and a sponge.
2. Remove all residues with a vacuum cleaner (fig. 24).

### 13.6 Cleaning the water tank

1. Clean the water tank (A17) regularly (about once a month) and whenever the water softener filter (D7) (if installed) is replaced with a damp cloth and a little mild washing up liquid. Rinse thoroughly before filling the tank and putting it back in the appliance;
2. Remove the filter (if installed) and rinse with running water;
3. Replace the filter (if installed), fill the tank with fresh water and replace;
4. (Models with water softener filter only) Deliver about 100ml of hot water to reactivate the filter.

### 13.7 Cleaning the coffee spouts

1. Clean the coffee spouts (A9) regularly with a sponge or cloth (fig. 25A);
2. Check the holes in the coffee spouts are not blocked. If necessary, remove coffee deposits with a toothpick (fig. 25B).

### 13.8 Cleaning the pre-ground coffee funnel

Check regularly (about once a month) that the pre-ground coffee funnel (A4) is not blocked. If necessary, remove coffee deposits with the brush (D5) supplied.

### 13.9 Cleaning the infuser

The infuser (A20) must be cleaned at least once a month.

#### **Important!**

The infuser cannot be removed when the machine is on.

1. Make sure the machine is correctly turned off (see section "5. Turning the appliance off");
2. Remove the water tank (A17) (fig. 3);
3. Open the infuser door (A19) (fig. 26) on the right side of the appliance;
4. Press the two coloured release buttons inwards and at the same time pull the infuser outwards (fig. 27);
5. Soak the infuser in water for about 5 minutes, then rinse under the tap;

#### **Important!**

RINSE WITH WATER ONLY

NO WASHING UP LIQUID - NO DISH WASHER

Clean the infuser without using washing up liquid as it could be damaged.

6. Use the brush (D5) to remove any coffee residues left in the infuser housing, visible through the infuser door;
7. After cleaning, replace the infuser by sliding it onto the internal support (fig. 28), then push the PUSH symbol fully in until it clicks into place;

#### **Please note!**

If the infuser is difficult to insert, before insertion, adapt it to the right size by pressing the two levers shown in fig. 29.

8. Once inserted, make sure the two coloured buttons have snapped out (fig. 30);
9. Close the infuser door;
10. Put the water tank back.

### 13.10 Cleaning the milk container

To keep the frother efficient, clean the milk container every two days as described below.

1. Remove the lid (E2);
2. Remove the milk spout (E5) and intake tube (E4) (fig. 31);
3. Turn the froth adjustment dial (E1) anticlockwise to the "INSERT" position (fig. 31) and pull it off upwards;

4. Wash all the components thoroughly with hot water and mild washing-up liquid. **All components are dishwasher safe, but must be placed in the top basket of the dishwasher.** Make sure there are no milk residues on the hollow and groove under the dial (fig. 32). If necessary, scrape the groove with a toothpick;

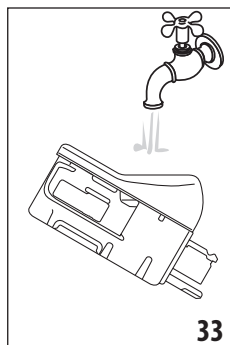

5. Rinse inside the froth adjustment dial seat with running water (fig. 33);

6. Check that the intake tube and spout are not clogged with milk residues;
7. Replace the dial (in correspondence to the word "INSERT"), spout and milk intake tube;
8. Place the lid back on the milk container (E2).



### 13.11 Cleaning the hot water nozzle

Each time you prepare milk, clean the connection nozzle (A8) with a sponge to remove milk residues from the gaskets (fig. 21).



## 14. DESCALING

### Important!

- Before use, read the instructions and the labelling on the descaler pack.
- You should use De'Longhi descaler only. Using unsuitable descalers, or failing to perform the descale procedure correctly, could lead to the machine developing faults not covered by the manufacturer's guarantee.

Descal the appliance when "DESCALING NEEDED" "PRESS OK TO START (~45min)" appears on the display: To descale immediately, press  and follow the operations from point 3. To descale the appliance later, press . The  symbol appears on the display to remind you that the appliance needs descaling. (the message appears each time you turn the appliance on).

To access the descaling menu:

1. Press the  button (C3) to enter the menu;
2. Press "DESCALE" and follow the instructions on the display;
3. "REMOVE WATER FILTER" (fig. 34): extract the water tank (A17), remove the water softener filter (D7) (if present) and empty the water tank. Press ;

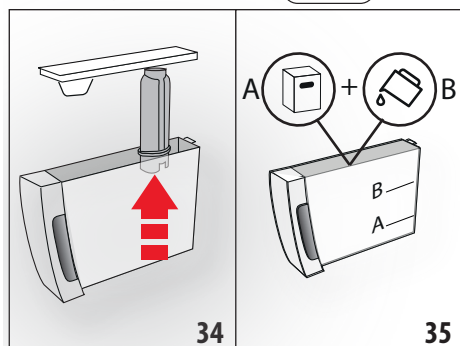

4. "DESCALER (LEVEL A)" "AND WATER (LEVEL B)" (fig. 35); Pour the descaler into the tank up to the level A marked inside the tank (equal to one 100ml pack), then add water

(one litre) up to level B and put the water tank back. Press

;

5. "EMPTY DRIP TRAY" (fig. 22);
6. Remove, empty and replace the drip tray (A15) and grounds container (A11). Press ;
7. "POSITION 2I CONTAINER" "OK TO START":

Place an empty container with a minimum capacity of 2 litres under the hot water spout (D6) and coffee spouts (A9) (fig. 9);

### Important! Danger of scalding

Hot water containing acid flows from the hot water and coffee spouts. Take care to avoid contact with splashes of this solution.

8. Press  to confirm that you have added the descaling solution. "DESCALING UNDERWAY" "PLEASE WAIT" is displayed: The descale programme starts and the descaler liquid comes out of the hot water and coffee spouts. A series of rinses is performed automatically to remove all the scale residues inside the coffee machine;

After about 25 minutes, descaling stops;

9. "RINSE AND FILL WATER TANK" "UP TO MAX LEVEL" (fig. 4): the appliance is now ready to rinse with fresh water. Empty the container used to collect the descaler solution. Extract the water tank, empty, rinse under running water, fill with fresh water up to the MAX level and put back in the appliance;
10. "POSITION 2I CONTAINER" "OK TO START RINSING": Place the container used to collect the descaler solution empty under the coffee spouts and hot water spout (fig. 9) and press ;
11. Hot water is delivered first from the coffee spouts, then from the hot water spout and "RINSING UNDERWAY" is displayed;

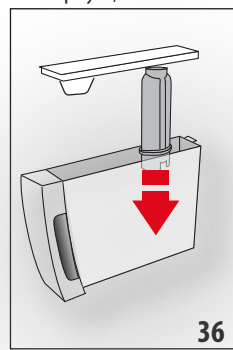

12. When the water in the tank has run out, empty the container used to collect the rinsing water;
13. (If the filter is installed) "INSERT FILTER" "INTO ITS HOUSING" (fig. 36). Press  and extract the water tank. Replace the water softener filter if removed previously;

14. "RINSE AND FILL WATER TANK" "UP TO MAX LEVEL" (fig. 4): Fill the tank up to the MAX level with fresh water;
15. "INSERT WATER TANK" (fig. 5): Put the water tank back in the appliance;

16. "POSITION 2| CONTAINER" "OK TO START RINSING": Place the container used to collect the descaler solution empty under the hot water spout (fig. 9) and press **Ok ✓**
17. Hot water is delivered from the hot water/steam spout and "RINSING UNDERWAY" "PLEASE WAIT" is displayed;
18. "EMPTY DRIP TRAY" (fig. 22): At the end of the second rinse, remove, empty and replace the drip tray (A15) and grounds container (A11) and press **Next >**;
19. "DESCALE COMPLETE": press **Ok ✓**;
20. "FILL TANK WITH" "FRESH WATER": empty the container used to collect the rinse water, remove the water tank and fill with fresh water up to the MAX level, then put back in the appliance.

The descaling cycle is now complete.

#### **Please note!**

- If the descaling cycle is not completed correctly (e.g. no electricity) we recommend repeating the cycle;
- After descaling, it is normal for the grounds container (A11) to contain water.
- If the water tank has not been filled to the MAX level, at the end of descaling, the appliance requests a third rinse to guarantee that the descaler solution has been completely eliminated from the machine's internal circuits. Before starting rinsing, remember to empty the drip tray;
- The appliance may request descaling cycles at very short intervals. This is normal and due to the appliance's advanced control system.





## **15. SETTING WATER HARDNESS**

The "DESCALING NEEDED" "PRESS OK TO START (~45MIN)" message is displayed after a period of time established according to water hardness.

The machine is set by default for a hardness value of "4". The machine can also be programmed according to the hardness of the mains water in the various regions so that the machine needs to be descaled less often.

### **15.1 Measuring water hardness**

1. Remove the TOTAL HARDNESS TEST indicator paper (D1) from its pack (attached to the English instructions).
2. Immerse the paper completely in a glass of water for one second.
3. Remove the paper from the water and shake lightly. After about a minute, 1, 2, 3, or 4 red squares form, depending on the hardness of the water. Each square corresponds to one level.

Indicator paper	Water hardness
	Level 1 - soft water
	Level 2 - slightly hard water
	Level 3 - hard water
	Level 4 - very hard water

### **15.2 Setting water hardness**

1. Access the menu as described in section "6.1 Access the settings menu";
2. Press "WATER HARDNESS";
3. "WATER HARDNESS" "CURRENT VALUE UNDERLINED": Press the required level (Level 1 = soft water; Level 4 = very hard water);
4. Press "**↶ Esc**" to go back to the homepage. The machine is now reprogrammed with the new water hardness setting.

## **16. WATER SOFTENER FILTER**

Certain models are fitted with a water softener filter (D4). If this is not the case with your model, you are recommended to purchase one from De'Longhi Customer Services. To use the filter correctly, follow the instructions below.

### **16.1 Installing the filter**

1. Remove the filter (D7) from the packaging;
2. Access the menu as described in section "6.1 Access the settings menu";
3. Press "WATER FILTER"; "TURN DATE INDICATOR TO NEXT 2 MONTHS" (fig. 37): turn the date disk to display the next 2 months of use.
4. Press **Next >**;

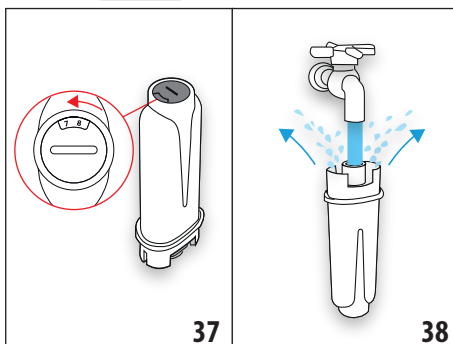

### Please note

The filter lasts about two months if the appliance is used normally. If the coffee machine is left unused with the filter installed, it will last a maximum of 3 weeks.

5. "RUN WATER INTO FILTER HOLE" "UNTIL IT COMES OUT" (fig. 38): To activate the filter, run tap water through the hole in the filter as shown in the figure until water comes out of the openings at the side for more than a minute. Press **Next >**;
6. Extract the tank (A17) from the appliance and fill with water.
7. "IMMERSE FILTER TO" "EXPEL AIR BUBBLES" (fig. 39): Insert the filter in the water tank and immerse it completely for about ten seconds, sloping it and pressing it lightly to enable the air bubbles to escape. Press **Next >**;

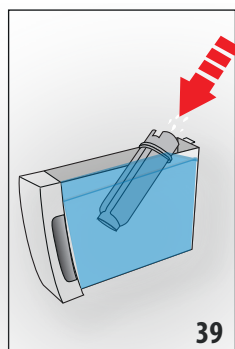

8. "INSERT FILTER" "IN HOUSING": Insert the filter (D7) in the filter housing (fig. 36) and press as far as it will go. Press **Next >**;
9. "INSERT WATER TANK": Close the tank with the lid (A17), then put the tank back in the machine (fig. 5);

10. "POSITION 0.5L CONTAINER" "OK TO ENABLE FILTER" (fig. 7): Place the container under the hot water spout (D6) and press **Ok ✓**. Delivery begins and stops automatically. The filter is now active and the coffee machine can be used.

### 16.2 Replacing the filter

Replace the filter (D7) when "REPLACE WATER FILTER" "PRESS OK TO START" appears on the display: to replace immediately, press **Ok ✓** and follow the instructions from point 5. To replace the filter later, press **↶ Esc**. The  symbol appears on the display to remind you that the filter needs replacing. To replace, proceed as follows:

1. Extract the tank (A17) and exhausted filter;
2. Remove the new filter from the packaging;
3. Access the menu as described in section "6.1 Access the settings menu";
4. Follow the operations described in the previous section from point 3.

The filter is now active and the coffee machine can be used.

### Please note!

After two months (see date indicator) or when the appliance has not been used for 3 weeks, you should replace the filter even if the message has not yet been displayed.

### 16.3 Removing the filter

If you want to use the appliance without the filter (D7), you must remove it and notify the appliance of its removal. Proceed as follows:

1. Extract the tank (A17) and exhausted filter;
2. Access the menu as described in section "6.1 Access the settings menu";
3. PRESS "WATER FILTER";
4. Press the selector corresponding to " REMOVE WATER FILTER";
5. "CONFIRM FILTER REMOVAL": press **Ok ✓** (or press **↶ Esc** to go back to the settings menu);
6. "FILTER REMOVED": the change has been saved. Press **Ok ✓** to go back to the homepage.



### Please note!



After two months (see date indicator) or when the appliance has not been used for 3 weeks, you should replace the filter even if the message has not yet been displayed.

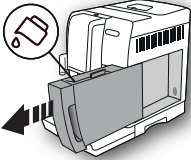
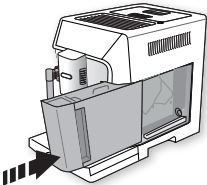
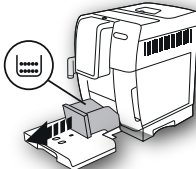
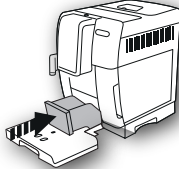

## 17. TECHNICAL DATA

Voltage:	220-240 V~ 50-60 Hz max. 10 A
Power:	1450 W
Pressure:	1.9 MPa (19 bars)
Water tank capacity:	1.8 l
Size LxHxD:	240x440x360 mm
Cord length:	1750 mm
Weight:	10 kg
Beans container capacity:	300 g
Frequency:	2400/2483.5 MHz
Maximum transmission power	10 mW

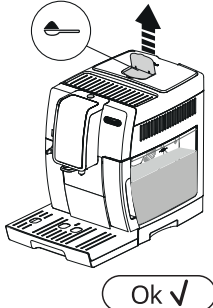
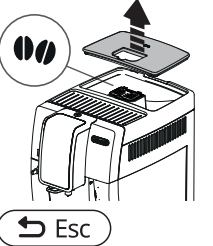
18.  **DISPLAYED MESSAGES**



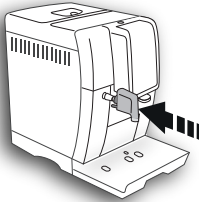
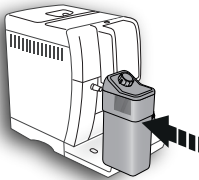
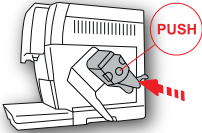

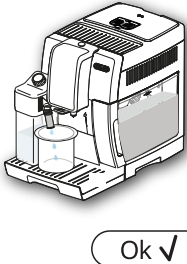
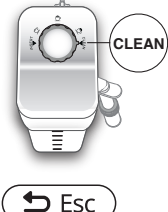
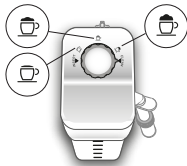
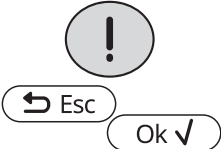
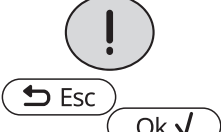

DISPLAYED MESSAGE	POSSIBLE CAUSE	REMEDY
<p>FILL TANK WITH FRESH WATER</p> 	<p>Insufficient water in the tank (A17).</p>	<p>Fill the tank with water and/or insert it correctly, pushing it as far as it will go until it clicks into place.</p>
<p>INSERT WATER TANK</p> 	<p>The tank (A17) is not correctly in place.</p>	<p>Insert the tank correctly and press as far as it will go.</p>
<p>EMPTY GROUNDS CONTAINER</p> 	<p>The grounds container (A11) is full.</p>	<p>Empty the grounds container and drip tray (A15), clean and put back in the appliance. Important: when removing the drip tray, the grounds container <b>MUST</b> be emptied, even if it contains few grounds. If this is not done, when you make the next coffees, the grounds container may fill up more than expected and clog the machine.</p>
<p>INSERT GROUNDS CONTAINER</p> 	<p>After cleaning, the grounds container (A11) has not been replaced.</p>	<p>Remove the drip tray (A15) and insert the grounds container.</p>
<p>ADD GROUND COFFEE MAX. ONE MEASURE</p> 	<p>The pre-ground coffee function has been selected without placing any pre-ground coffee in the funnel (A4).</p>	<p>Place pre-ground coffee in the funnel (fig. 12) and repeat delivery</p>

DISPLAYED MESSAGE	POSSIBLE CAUSE	REMEDY
<p data-bbox="84 130 311 183">ADD GROUND COFFEE MAX. ONE MEASURE</p> 	<p data-bbox="330 130 677 183">A LONG coffee with pre-ground coffee has been requested</p>	<p data-bbox="696 130 1036 215">Place pre-ground coffee in the funnel (A4) (fig. 12) and press the selector corresponding to "OK" to continue and complete delivery.</p>
<p data-bbox="84 513 311 534">FILL BEANS CONTAINER</p> 	<p data-bbox="330 513 677 534">The coffee beans have run out.</p> <p data-bbox="330 550 677 571">The pre-ground coffee funnel (A4) is clogged.</p>	<p data-bbox="696 513 1036 534">Fill the beans container (A4) (fig. 10).</p> <p data-bbox="696 550 1036 635">Empty the funnel with the help of the brush (D5) as described in section "13.8 Cleaning the pre-ground coffee funnel".</p>
<p data-bbox="84 801 311 853">GROUND TOO FINE. ADJUST MILL</p> 	<p data-bbox="330 801 677 853">The grinding is too fine and the coffee is delivered too slowly or not at all.</p> <p data-bbox="330 1077 677 1152">If the water softener filter (D7) is present, an air bubble may have been released inside the circuit, obstructing delivery.</p>	<p data-bbox="696 801 1036 1061">Repeat coffee delivery and turn the grinding adjustment dial (A5) (fig. 13) one click clockwise towards "7" while the coffee mill is in operation. If after making at least 2 coffees delivery is still too slow, repeat the correction procedure, turning the grinding adjustment dial another click until delivery is correct (see section "7.5 Adjusting the coffee mill"). If the problem persists, make sure the water tank (A17) is fully inserted.</p> <p data-bbox="696 1077 1036 1152">Insert the hot water spout (D6) in the appliance and deliver a little water until the flow becomes regular.</p>
<p data-bbox="84 1168 311 1220">SELECT A Milder TASTE OR REDUCE COFFEE AMOUNT</p> 	<p data-bbox="330 1168 677 1189">Too much coffee has been used.</p>	<p data-bbox="696 1168 1036 1252">Select a milder taste by pressing the "AROMA" button (C5) or reduce the quantity of ground coffee (maximum 1 measure).</p>

DISPLAYED MESSAGE	POSSIBLE CAUSE	REMEDY
<p data-bbox="87 132 252 156">INSERT WATER SPOUT</p> 	<p data-bbox="330 132 674 188">The hot water spout (D6) is not inserted or is inserted incorrectly</p>	<p data-bbox="696 132 994 156">Insert the water spout as far as it will go.</p>
<p data-bbox="87 432 274 456">INSERT MILK CONTAINER</p> 	<p data-bbox="330 432 674 456">The milk container (E) is not inserted correctly.</p>	<p data-bbox="696 432 1039 488">Insert the milk container, pushing it as far as it will go.</p>
<p data-bbox="87 708 296 732">INSERT INFUSER ASSEMBLY</p> 	<p data-bbox="330 708 674 764">The infuser (A20) has not been replaced after cleaning.</p>	<p data-bbox="696 708 1039 764">Insert the infuser as described in section "13.9 Cleaning the infuser".</p>
<p data-bbox="87 935 263 986">WATER CIRCUIT EMPTY PRESS OK TO START</p>  <p data-bbox="191 1193 311 1225">Ok ✓</p>	<p data-bbox="330 935 520 959">The water circuit is empty</p>	<p data-bbox="696 935 1039 1074">Press the selector corresponding to "OK" to deliver water from the spout (D6) until it flows out normally. If the problem persists, make sure the water tank (A17) is fully inserted.</p>





DISPLAYED MESSAGE	POSSIBLE CAUSE	REMEDY
<p>PRESS OK TO CLEAN OR TURN DIAL</p> 	<p>The milk container has been inserted with the froth adjustment dial (E1) in the CLEAN position.</p>	<p>To proceed with the CLEAN function, press the selector corresponding to "OK", or turn the froth adjustment dial to one of the milk positions.</p>
<p>TURN MILK FROTH ADJUSTMENT DIAL TO CLEAN POSITION</p> 	<p>Milk has been delivered recently and the tubes inside the milk container (E) must be cleaned.</p>	<p>Turn the froth adjustment dial (E1) to CLEAN (fig. 19).</p>
<p>TURN FROTH ADJUSTMENT DIAL</p> 	<p>The milk container has been inserted with the froth adjustment dial (E1) in the CLEAN position.</p>	<p>Turn the dial to the required froth position.</p>
<p>DESCALING NEEDED PRESS OK TO START (~45MIN)</p> 	<p>The machine must be descaled.</p>	<p>Press the selector corresponding to "OK" to start descaling or "ESC" to descale later. The descaling procedure described in section "14. Descaling" needs to be performed.</p>
<p>REPLACE WATER FILTER PRESS OK TO START</p> 	<p>The water softener filter (D7) is exhausted.</p>	<p>Press the selector corresponding to "OK" to replace or remove the filter, or "ESC" to carry out the procedure later. Follow the instructions in section "16. Water softener filter".</p>

DISPLAYED MESSAGE	POSSIBLE CAUSE	REMEDY
GENERAL ALARM: REFER TO USER MANUAL / APP 	The inside of the appliance is very dirty.	Clean the inside of the appliance thoroughly, as described in section "13. Cleaning". If the message is still displayed after cleaning, contact a customer service centre.
	The tubes inside the milk container (E) must be cleaned.	Turn the froth adjustment dial (E1) to CLEAN (fig. 19).
	Reminds you the filter (D7) must be replaced.	Replace the filter or remove it as described in section "16. Water softener filter".
	The machine must be descaled.	The descaling procedure described in section "14. Descaling" needs to be performed. The appliance may request descaling cycles at very short intervals. This is normal and due to the appliance's advanced control system.
	Energy saving is enabled.	To disable the function, proceed as described in section "6.8 Energy saving  ".
	The appliance is connected to a device via bluetooth.	
CLEANING UNDERWAY PLEASE WAIT	The appliance has detected impurities in its internal circuits.	Wait for the appliance to be ready for use again and reselect the required beverage. Contact Customer Services if the problem persists.

## 19. TROUBLESHOOTING

Below is a list of some of the possible malfunctions.

If the problem cannot be resolved as described, contact Customer Services.

PROBLEM	POSSIBLE CAUSE	REMEDY
The coffee is not hot.	The cups were not preheated.	Warm the cups by rinsing them with hot water (Please note: you can use the hot water function).
	The infuser has cooled down because 2/3 minutes have elapsed since the last coffee was made.	Before making the coffee, heat the infuser by rinsing using the rinse function (see section "6.3 Rinse  ").
	A low coffee temperature is set.	Set a hotter coffee temperature in the menu (see section "6.9 Coffee temperature  ").
The coffee is weak or not creamy enough.	The coffee is ground too coarsely.	Turn the grinding adjustment dial (A5) one click anticlockwise towards "1" while the coffee mill is in operation (fig. 13). Continue one click at a time until coffee delivery is satisfactory. The effect is only visible after delivering 2 coffees (see section "7.5 Adjusting the coffee mill").
	The coffee is unsuitable.	Use coffee for espresso machines.
	The coffee is not fresh.	The coffee pack has been opened for too long and has lost its taste.
The coffee is delivered too slowly or a drop at a time.	The coffee is ground too finely.	Turn the grinding adjustment dial (A5) one click clockwise towards "7" while the coffee mill is in operation (fig. 13). Continue one click at a time until coffee delivery is satisfactory. The effect is only visible after delivering 2 coffees (see section "7.5 Adjusting the coffee mill").
Coffee does not come out of one or both of the spouts.	The coffee spouts (A9) are blocked.	Clean the spouts with a toothpick (fig. 25B).
The appliance will not make coffee	The appliance has detected impurities in its internal circuits. "Cleaning underway" is displayed.	Wait for the appliance to be ready for use again and reselect the required beverage. Contact Customer Services if the problem persists.
The appliance does not come on	The power cord connector (D7) is not inserted correctly.	Insert the connector as far as it will go in the socket at the back of the appliance (fig. 1).
	It is not plugged into the mains socket.	Plug into the mains socket (fig. 1).
	The main switch (A22) is not turned on.	Press the main switch (fig. 2).
The infuser cannot be extracted	The appliance has not been turned off correctly	Turn the appliance off by pressing the  button (A15) (see section "5. Turning the appliance off").

<b>PROBLEM</b>	<b>POSSIBLE CAUSE</b>	<b>REMEDY</b>
At the end of descaling, the appliance requests a third rinse	During the two rinse cycles, the water tank (A17) has not been filled to the MAX level	Follow the instructions displayed by the appliance, but first empty the drip tray (A15) to avoid the water overflowing.
Milk does not flow from the milk spout (E5)	The milk container (E) lid (E2) is dirty	Clean the milk container lid as described in section "13.10 Cleaning the milk container".
The milk contains large bubbles and squirts out of the milk spout (E5) or there is little froth	The milk is not cold enough or is not semi-skimmed or skimmed.	Use skimmed or semi-skimmed milk at refrigerator temperature (about 5° C). If the result is not as expected, try a different brand of milk.
	The froth adjustment dial (E1) is incorrectly adjusted.	Adjust following the instructions in section "8.  making cappuccinos and milk-based coffees".
	The milk container lid (E2) or froth adjustment dial (E1) are dirty	Clean the milk container lid and dial as described in section "13.10 Cleaning the milk container".
	The hot water connection nozzle (A8) is dirty	Clean the connection nozzle as described in section "13.11 Cleaning the hot water nozzle".
The machine emits noises or small puffs of steam while not in use	The machine is ready for use, or has recently been turned off, and condensate is dripping into the hot vaporiser	This is part of normal operation. To limit the phenomenon, empty the drip tray.