ECAM45.76X

COFFEE MAKER

Instructions for use. Keep these instructions

Visit www.delonghiregistration.com to register
your product

Visit www.delonghi.com for a list of service centers
near you.

ELECTRIC CHARACTERISTICS

120V~ 60 Hz 1250 W

MACHINE À CAFÉ

Mode d'emploi . Conservez cette notice

Visitez www.delonghiregistration.com pour
enregistrer votre produit en ligne.

Visitez www.delonghi.com pour y voir une liste des
centres de réparation proches de chez vous.

CARACTÉRISTIQUES ÉLECTRIQUES

120V~ 60 Hz 1250 W

CAFETERA

Repase y guarde estas instrucciones.

Lea cuidadosamente este instructivo antes de usar
su aparato.

Visite www.delonghiregistration.com para registrar
su producto en línea.

Visite www.delonghi.com para ver la lista de
centros de servicios cercanos a usted.

CARACTERISTICAS ELECTRICAS:

120V~ 60 Hz 1250 W



DeLonghi

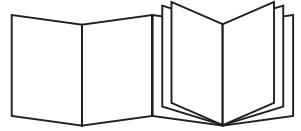

B

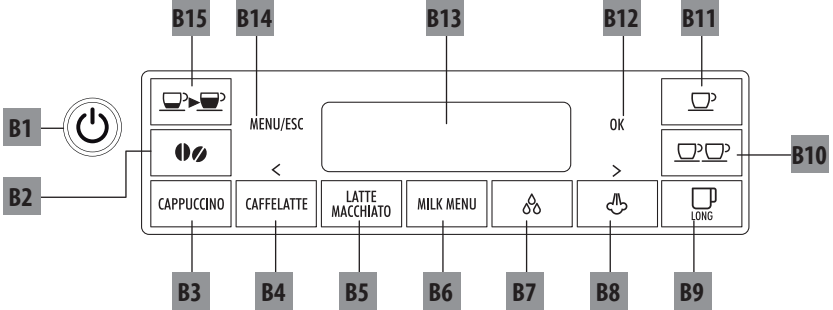

C

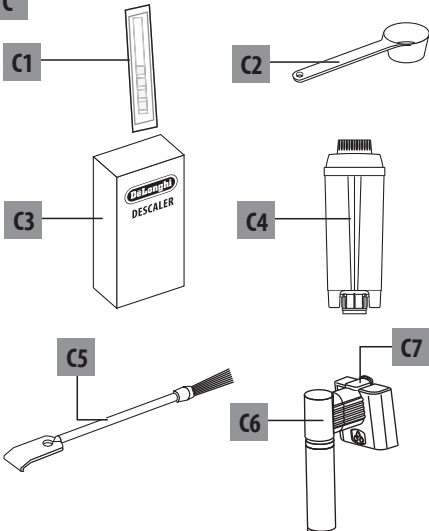

D

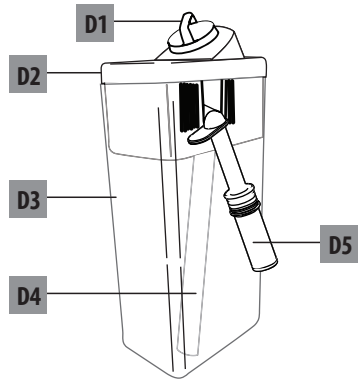

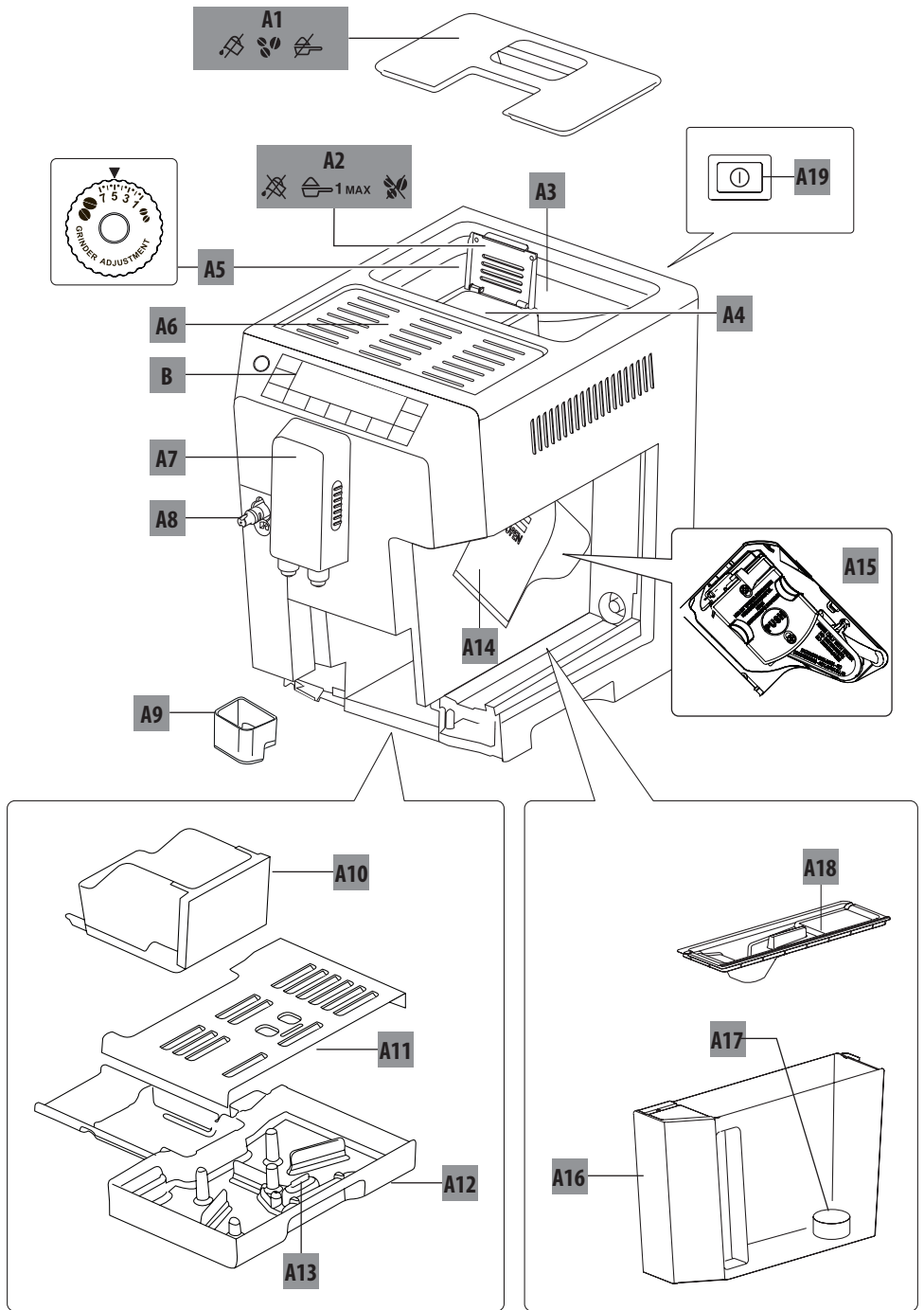

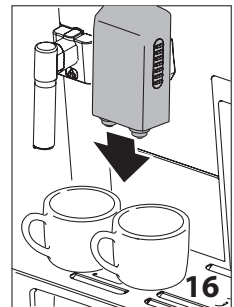
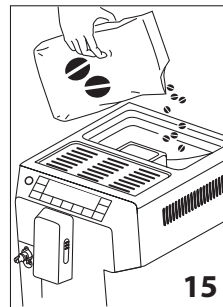
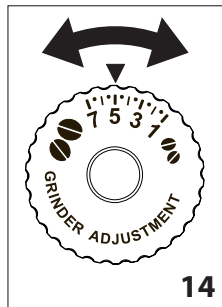
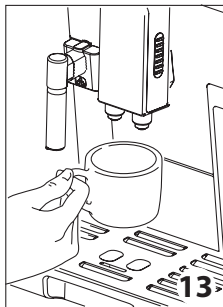
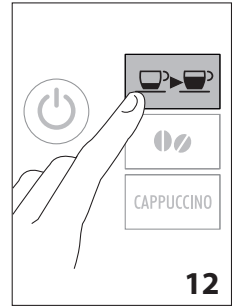
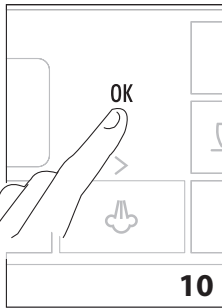
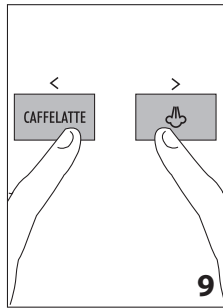
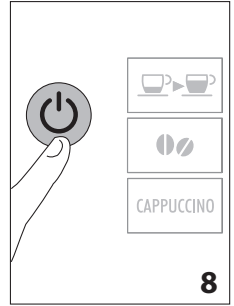
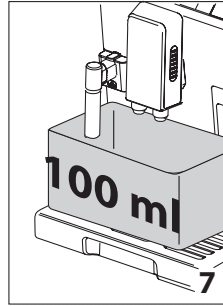
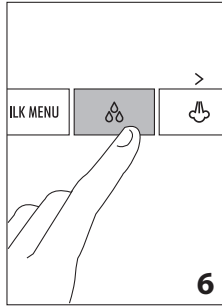
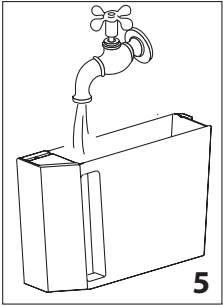
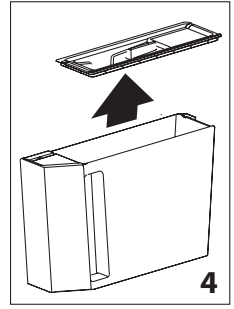
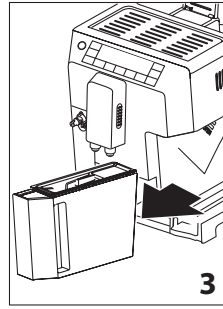
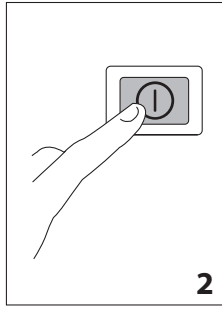
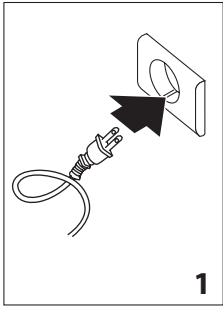

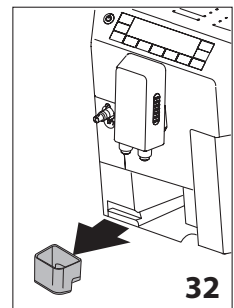
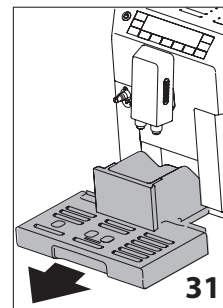
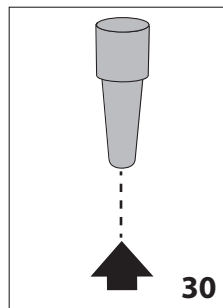
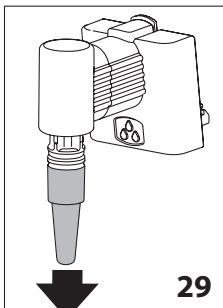
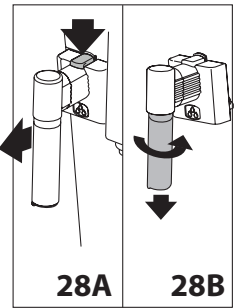
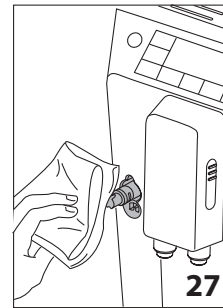
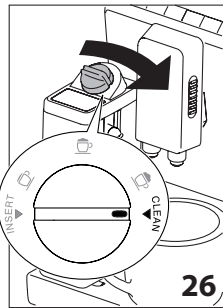
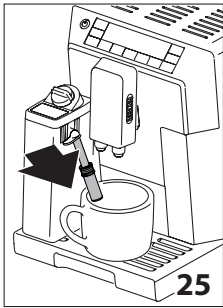
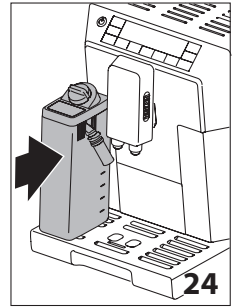
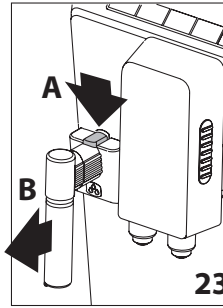
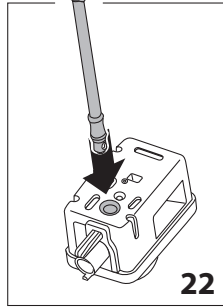
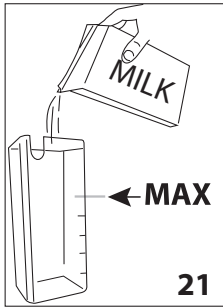
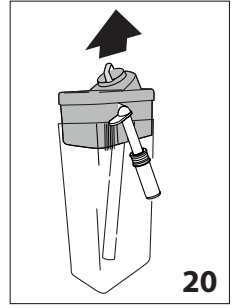
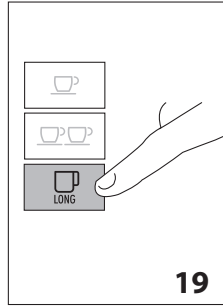
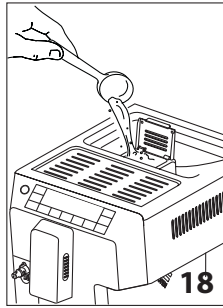
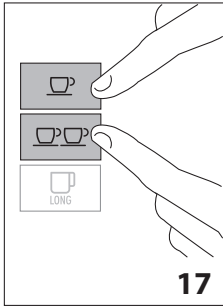

CONTENTS

1. IMPORTANT SAFEGUARDS	7
1.1 Short cord instructions	7
2. INTRODUCTION	8
2.1 Symbols used in these instructions	8
2.2 Letters in brackets	8
2.3 Troubleshooting and repairs.....	8
2.4 Video instruction manual available on:	8
3. DESCRIPTION	8
3.1 Description of the appliance.....	8
3.2 Description of the control panel	8
3.3 Description of the accessories.....	9
3.4 Description of the milk container	9
4. BEFORE USE	9
4.1 Checking the appliance	9
4.2 Installing the appliance.....	9
4.3 Connecting the appliance.....	9
4.4 Setting up the appliance	9
5. TURNING THE APPLIANCE ON	10
6. TURNING THE APPLIANCE OFF	10
7. MENU SETTINGS	10
7.1 Rinsing.....	10
7.2 Descaling	10
7.3 Install filter.....	10
7.4 Replacing the water softener filter (if installed).....	10
7.5 Adjust time	10
7.6 Auto-start	11
7.7 Auto-off (standby)	11
7.8 Cup warmer.....	11
7.9 Energy saving.....	11
7.10 Setting the temperature	11
7.11 Setting water hardness	11
7.12 Setting the language	12
7.13 Beep.....	12
7.14 Default values (reset)	12
7.15 Statistics function.....	12
8. MAKING COFFEE	12
8.1 Selecting the coffee taste	12
8.2 Selecting the quantity of coffee in the cup ..	12
8.3 Customising the "my coffee" quantity	12
8.4 Adjusting the coffee mill	13
8.5 Tips for a hotter coffee.....	13
8.6 Making coffee using coffee beans	13
8.7 Making coffee using pre-ground coffee.....	13
8.8 Making LONG coffee using coffee beans	13
8.9 Making LONG coffee using pre-ground coffee ..	14
8.10 Customising the LONG coffee quantity	14
9. MAKING CAPPUCCINOS AND MILK-BASED COFFEES	14
9.1 Filling and attaching the milk container.....	14
9.2 Adjusting the amount of froth.....	14
9.3 Making cappuccinos and milk-based coffees automatically	14
9.4 Preparing "MILK MENU" drinks	15
9.5 Cleaning the milk container after every use	15
9.6 Programming the quantity of coffee and milk in the cup for the CAPPUCCINO, CAFFELATTE and LATTE MACCHIATO buttons	15
9.7 Programming the quantity of coffee and milk in the cup for MILK MENU drinks	15
10. DELIVERING HOT WATER AND STEAM	16
10.1 Hot water	16
10.2 Changing the quantity of water delivered automatically	16
10.3 Steam delivery	16
10.4 Tips for using steam to froth milk.....	16
10.5 Cleaning the spout after use.....	16
11. CLEANING	17
11.1 Cleaning the machine	17
11.2 Cleaning the machine's internal circuit.....	17
11.3 Cleaning the coffee grounds container	17
11.4 Cleaning the drip tray and condensate tray ..	17
11.5 Cleaning the inside of the coffee machine...	17
11.6 Cleaning the water tank.....	18
11.7 Cleaning the coffee spouts	18
11.8 Cleaning the pre-ground coffee funnel	18
11.9 Cleaning the infuser	18
11.10 Cleaning the milk container	19
11.11 Cleaning the hot water/steam connection nozzle.....	19
12. DESCALING	19
13. SETTING WATER HARDNESS	20
13.1 Measuring water hardness	20
13.2 Setting water hardness	20
14. WATER SOFTENER FILTER	20
14.1 Installing the filter	20
14.2 Replacing the filter.....	21
14.3 Removing the filter	21
15. TECHNICAL DATA	21
16. DISPLAYED MESSAGES	22
17. TROUBLESHOOTING	23

1. IMPORTANT SAFEGUARDS

When using electrical appliances, basic safety precautions should always be followed, including the following.

- Read all instructions carefully.
- Make sure the voltage of your electrical system corresponds to the voltage shown on the bottom of the machine.
- Do not touch hot surfaces. Use handles or knobs.
- To protect against fire, electrical shock and personal injury, do not immerse cord, plug or appliance in water or other liquid.
- Keep the appliance out of the reach of children and do not leave appliance unattended while in operation.
- Unplug from the outlet when not in use and before cleaning.
- Do not operate with a damaged cord or plug, or after the appliance malfunctions, or has been damaged in any manner. Return the appliance to the nearest authorized service facility for examination, repair or adjustment.
- The use of accessory attachments not recommended by the manufacturer may result in fire, electrical shock, or personal injury.
- Do not use outdoors.
- Make sure the power cord does not hang over the edge of the table or counter-top to avoid getting accidentally caught or entangled.
- Do not place the appliance or its electrical parts on or near electric stoves, cooking surfaces, or gas burners.
- Plug cord into the wall outlet. To disconnect, first turn machine "off", then remove plug from wall outlet.
- Do not use the appliance for other than the intended use. This appliance is to be utilized for domestic use only. The manufacturer declines all responsibility for any damage caused by improper, incorrect, or irresponsible use.

WARNING: To reduce the risk of fire or electric shock, do not remove the cover or the exterior of the unit. Don't attempt to repair or modify the machine, doing so will void the warranty. Repair should be done by authorized service personnel only!

SAVE THESE INSTRUCTIONS
THIS APPLIANCE IS FOR HOUSEHOLD USE ONLY

1.1 Short cord instructions

- A short power cord is provided to reduce risks resulting from becoming entangled in or tripping over a longer cord.
- Longer, detachable power supply cords or extension cords are available and may be used if care is exercised in their use.
- If an extension cord is used, the marked electrical rating should be at least as great as the electrical rating of the appliance. If the appliance is provided with 3- wire, grounding type cord, the extension should be a GROUNDING TYPE 3 - WIRE CORD. The longer cord should be arranged so that it will not drape over the counter-top or table top where it can be pulled on by children or tripped over.
- Your product is equipped with a polarized alternating current line plug (a plug having one blade wider than the other). This plug will fit into the power outlet only one way. This is a safety feature. If you are unable to insert the plug fully into the outlet, try reversing the plug. If the plug should still fail to fit, contact your electrician to replace your obsolete outlet. Do not defeat the safety purpose of the polarized plug.

2. INTRODUCTION

Thank you for choosing the ECAM45760 automatic coffee and cappuccino maker.

We hope you enjoy using your new appliance.

Take a few minutes to read these instructions.

This will avoid all risks and damage to the machine.

2.1 Symbols used in these instructions

Important warnings are identified by these symbols.

It is vitally important to observe these warnings.



Danger!

Failure to observe the warning could result in life threatening injury from electric shock.



Important!

Failure to observe the warning could result in injury or damage to the appliance.



Danger of burns!

Failure to observe the warning could result in scalds.



Please note:

This symbol identifies important advice or information for the user.

2.2 Letters in brackets

The letters in brackets refer to the legend in the Description of the Appliance on page 3.

2.3 Troubleshooting and repairs

In the event of problems, first try and resolve them following the information given in the section "16. DISPLAYED MESSAGES" and "17. TROUBLESHOOTING".

If this does not resolve the problem or you require further information, you should consult Customer Experience by calling the number given on the annexed "Customer Experience" sheet. If your country is not among those listed on the sheet, call the number given in the guarantee.

If repairs are required, contact De'Longhi Customer Experience only.

Contact details are given in the guarantee certificate provided with the appliance.

2.4 Video instruction manual available on:

<http://ecam45760.delonghi.com>

3. DESCRIPTION

3.1 Description of the appliance





(page 3 - A)

- A1. Beans container lid
- A2. Pre-ground coffee funnel lid
- A3. Beans container
- A4. Pre-ground coffee funnel
- A5. Grinding adjustment dial
- A6. Cup warmer shelf
- A7. Coffee spout (adjustable height)
- A8. Hot water and steam connection nozzle
- A9. Condensate tray
- A10. Coffee grounds container
- A11. Cup tray
- A12. Drip tray
- A13. Drip tray water level indicator
- A14. Infuser door
- A15. Infuser
- A16. Water tank
- A17. Water softener filter housing
- A18. Water tank lid
- A19. Main switch

3.2 Description of the control panel

(page 2 - B)

A number of buttons on the panel have a double function. This is indicated in brackets in the description.

- B1.  button: turns the appliance on and off (standby)
- B2.  aroma selection button: to select the coffee taste
- B3. **CAPPUCCINO** button: to deliver a cappuccino
- B4. **CAFFELATTE** button: to deliver a caffelatte (*When in the settings menu, press to scroll through the menu*)
- B5. **LATTE MACCHIATO** button: to deliver a macchiato
- B6. **MILK MENU** button: to access preparation of MILK, FLAT WHITE, ESPRESSO MACCHIATO and MY MILK
- B7.  button to deliver hot water
- B8.  button: to deliver steam (*When in the settings menu, press to scroll through the menu*)
- B9.  button: to make 1 cup of LONG coffee
- B10.  button: to make 2 cups of coffee with the settings displayed
- B11.  button: to make 1 cup of coffee with the settings displayed
- B12. **OK** button: to enable and confirm the selected function
- B13. **Display**: guides the user in using the appliance
- B14. **MENU/ESC** button to enter the menu (*When in the settings menu, press to exit the menu*)
- B15.  button: to select coffee quantity

3.3 Description of the accessories

(page 2 - C)

- C1. "Total Hardness Test" indicator paper
- C2. Pre-ground coffee measure
- C3. Descaler
- C4. Water softener filter (certain models only)
- C5. Cleaning brush
- C6. Cappuccino maker/hot water spout
- C7. Cappuccino maker/hot water spout release button

3.4 Description of the milk container

(page 2 - D)

- D1. Froth adjustment and CLEAN dial
- D2. Milk container lid
- D3. Milk container
- D4. Milk intake tube
- D5. Frothed milk spout (adjustable)

4. BEFORE USE

4.1 Checking the appliance

After removing the packaging, make sure the product is complete and undamaged and that all accessories are present. Do not use the appliance if it is visibly damaged. Contact De'Longhi Customer Services.

4.2 Installing the appliance



Important!

When you install the appliance, you should respect the following safety warnings:

- The appliance gives off heat. After positioning the appliance on the worktop, leave a space of at least 3 cm between the surfaces of the appliance and the side and rear walls and at least 15 cm above the coffee maker.
- Water penetrating the coffee maker could cause damage. Do not place the appliance near taps or sinks.
- The appliance could be damaged if the water it contains freezes. Do not install the appliance in a room where the temperature could drop below freezing point.
- Arrange the power cord in such a way that it cannot be damaged by sharp edges or contact with hot surfaces (e.g. electric hot plates).

4.3 Connecting the appliance



Important!

Check that the mains power supply voltage corresponds to that indicated on the rating plate on the bottom of the appliance. Connect the appliance to an efficiently earthed and correctly installed socket with a minimum current rating of 10A only.

If the power socket does not match the plug on the appliance, have the socket replaced with a suitable type by a qualified electrician.

4.4 Setting up the appliance



Please note!

- Coffee has been used to factory test the appliance and it is therefore completely normal for there to be traces of coffee in the mill. The machine is, however, guaranteed to be new.
 - The appliance is set with ENGLISH language: if you want to change the language, please see paragraph "7.12 Setting the language".
 - You should customise water hardness as soon as possible following the instructions in section "13. SETTING WATER HARDNESS".
1. Connect the appliance to the mains electricity supply (fig. 1) and make sure the main switch (A19) at the back of the appliance is pressed down (fig. 2).
 2. Remove the water tank (A16- fig. 3), open the lid (A18- fig. 4), fill to the MAX line with fresh water (fig. 5), replace the lid and put the tank back in the appliance.
- Follow the instructions indicated on the appliance display:
3. "INSERT WATER SPOUT": Check that the hot water spout (C6) is inserted on the connection nozzle (A8) and place a container holding a minimum of 33,38 fl.oz/100 ml underneath (fig. 7).
 4. "HOT WATER Press OK" is displayed;
 5. Press the **OK** button (B12) to confirm (fig. 10). The appliance delivers water from the spout then goes off automatically.

The coffee machine is now ready for normal use.



Please note!

- When setting up the appliance, you need to make 4-5 cups of coffee or 4-5 cappuccinos before the appliance starts to give satisfactory results.
- When making the first 5-6 cappuccinos, it is normal to hear the noise of boiling water. After this, the noise becomes less.
- To enjoy your coffee even more and improve the performance of your appliance, we recommend installing a water softener filter (C4) as described in section "14. WATER SOFTENER FILTER". If your model is not provided with a filter, you can request one from De'Longhi Customer Services.

5. TURNING THE APPLIANCE ON

Please note!

Before turning the appliance on, make sure the main switch (A19) is pressed (fig. 2).

Each time the appliance is turned on, it performs an automatic preheat and rinse cycle which cannot be interrupted. The appliance is ready for use only after completion of this cycle.

Danger of burns!

During rinsing, a little hot water comes out of the coffee spouts (A7) and is collected in the drip tray (A12) underneath. Avoid contact with splashes of water.

- To turn the appliance on, press the  button (B1-fig. 8). The message "Heating up, Please wait" appears on the display (B13).

When heating is complete, the message changes to "RINSING". As well as heating the boiler, this also heats the internal circuits by circulating hot water.

The appliance is at temperature when the message indicating the taste and quantity of coffee appears.

6. TURNING THE APPLIANCE OFF

Whenever the coffee machine is turned off after being used to make coffee, it performs an automatic rinse cycle.

Danger of burns!

During rinsing, a little hot water flows from the coffee spouts (A7). Avoid contact with splashes of water.

- To turn the appliance off, press the  button (B1- fig. 8).
- The message "Turning off underway Please wait" appears on the display (B13), then, if necessary, the appliance performs a rinse cycle and goes off (standby).

Please note!

If you will not be using the appliance for some time, unplug from the mains socket:

- first turn the appliance off by pressing the  button;
- release the main switch (A19) at the back of the appliance (fig. 2).

Important!

Never press the main switch while the appliance is on.

7. MENU SETTINGS

7.1 Rinsing

Use this function to deliver hot water from the coffee spout (A7) and from the cappuccino maker/hot water spout (C6), if inserted, to clean and heat the appliance's internal circuit.

Place a container with a minimum capacity of 33,38 fl.oz/100 ml under the cappuccino maker/hot water spout (fig. 7).

To enable the function, proceed as follows:

1. Press the **MENU/ESC** button (B14) to enter the menu;
2. Press < (B4) or > (B8) (fig. 9) until "Rinsing" appears on the display (B13);
3. Press the **OK** button (B12-fig. 10): the message "Confirm?" is displayed;

Danger of burns!

Do not leave the appliance unattended while hot water is being delivered.

4. Press the **OK** button. "RINSING Please wait" is displayed;
5. After a few seconds, hot water is delivered first from the coffee spouts (A7), then from the cappuccino maker/hot water spout (C6) (if inserted) to heat the appliance's internal circuit. "RINSING" is displayed, together with a progress bar which fills gradually as preparation proceeds;
6. To stop the process press any button or wait for delivery of water to stop automatically.

Please note!

- If the appliance is not used for more than 3-4 days, when switched on again, we strongly recommend performing 2/3 rinses before use;
- After cleaning, it is normal for the grounds container (A10) to contain water.

7.2 Descaling

For instructions on descaling, see section "12. DESCALING".

7.3 Install filter

For instructions on how to install the filter, see section "14. WATER SOFTENER FILTER".

7.4 Replacing the water softener filter (if installed)

For instructions on how to replace the filter, see section "14.2 Replacing the filter".

7.5 Adjust time

To adjust the time on the display (B13), proceed as follows:

1. Press the **MENU/ESC** button (B14) to enter the menu;
2. Press < (B4) or > (B8) (fig. 9) until "Adjust time" is displayed;
3. Press the **OK** button (B12-fig. 10): the hours flash on the display;
4. Press < or > to change the hour;
5. Press the **OK** button to confirm. The minutes flash;
6. Press < or > to change the minutes;
7. Press the **OK** button to confirm.

The time is set. Press the **MENU/ESC** button to exit the menu.

7.6 Auto-start

You can set the auto-start time in order to have the appliance ready at a certain time (for example in the morning) so you can make coffee immediately.



Please note!

To enable this function, the time must already be set correctly.

To enable auto-start, proceed as follows:

1. Press the **MENU/ESC** button (B14) to enter the menu;
2. Press < (B4) or > (B8) (fig. 9) until "Auto-start" appears on the display (B13);
3. Press the **OK** button (B12- fig. 10). "Enable?" is displayed;
4. Press the **OK** button to confirm;
5. Press < or > to choose the hour;
6. Press the **OK** button to confirm;
7. Press < or > to change the minutes;
8. Press the **OK** button to confirm;
9. Press the **MENU/ESC** button to exit the menu.

Once the time has been confirmed, activation of auto-start is indicated by the  symbol displayed alongside the time.

To disable the function:

1. Select auto-start from the menu;
2. Press the **OK** button. "Disable?" is displayed;
3. Press the **OK** button to confirm.

The  symbol is no longer displayed.

7.7 Auto-off (standby)

Auto-off can be set so that the appliance goes off after 15 or 30 minutes, or 1, 2 or 3 hours.

To programme Auto-off, proceed as follows:

1. Press the **MENU/ESC** button (B14) to enter the menu;
2. Press < (B4) or > (B8) (fig. 9) until "Auto-start" appears on the display (B13);
3. Press the **OK** button (B12- fig. 10);
4. Press < or > until the required operating time (15 or 30 minutes, or 1, 2 or 3 hours) is displayed;
5. Press the **OK** button to confirm;
6. Press the **MENU/ESC** button to exit the menu.

Auto-off is now programmed.

7.8 Cup warmer

This function enables the cup warmer to be enabled or disabled. Proceed as follows:

1. Press the **MENU/ESC** button (B14) to enter the menu;
2. Press < (B4) or > (B8) (fig. 9) until "Cup warmer" appears on the display (B13);
3. Press the **OK** button (B12- fig. 10). "Enable?" or "Disable?" is displayed;

4. Press the **OK** button to enable or disable the cup warmer (the message "Cup warmer Enabled" indicates that it is active);
 5. Press the **MENU/ESC** button to exit the menu.
- Warming the cups keeps the coffee hot.

7.9 Energy saving

Use this function to enable or disable energy saving. When enabled, the function reduces energy consumption in compliance with European regulations.

To disable (or enable) energy saving, proceed as follows:

1. Press the **MENU/ESC** button (B14) to enter the menu;
2. Press < (B4) or > (B8) (fig. 9) until "Energy Saving" appears on the display (B13);
3. Press the **OK** button (B12- fig. 10). "Disable?" is displayed (or "Enable?" if the function has been disabled);
4. Press the **OK** button to disable (or enable) energy saving mode;
5. Press the **MENU/ESC** button to exit the menu.

When the function is active, if the machine is not used for some time, "Energy saving" is displayed.



Please note!

- When in energy saving mode, a few seconds elapse before the first coffee, cappuccino or milk based coffee is delivered as the appliance must heat up again.
- To prepare any drink, press any button to exit energy saving, then press the button corresponding to the drink you want to make.
- If the milk container is inserted, "Energy saving" is not activated.

7.10 Setting the temperature

To modify the temperature of the water used to make the coffee, proceed as follows:

1. Press the **MENU/ESC** button (B14) to enter the menu;
2. Press < (B4) or > (B8) (fig. 9) until "Set temperature" appears on the display (B13);
3. Press the **OK** button (B12- fig. 10);
4. Press < or > until the required temperature is displayed (●=low; ●●●●=maximum);
5. Press the **OK** button to confirm;
6. Press the **MENU/ESC** button to exit the menu.

7.11 Setting water hardness

For instructions on setting water hardness, see section "13.2 Setting water hardness".

7.12 Setting the language

To modify the language of the display (B13), proceed as follows:

1. Press the **MENU/ESC** button (B14) to enter the menu;
2. Press < (B4) or > (B8) (fig. 9) until "Set language" is displayed;
3. Press the **OK** button (B12- fig. 10);
4. Press < or > until the required language is displayed;
5. Press the **OK** button to confirm;
6. A message confirming the language installed is displayed;
7. Press the **MENU/ESC** button to exit the menu.

7.13 Beep

This enables or disables the beep emitted by the machine each time a button is pressed or an accessory is inserted/removed. To disable or re-enable the beep, proceed as follows:

1. Press the **MENU/ESC** button (B14) to enter the menu;
2. Press < (B4) or > (B8) (fig. 9) until "Beep" appears on the display (B13);
3. Press the **OK** button (B12- fig. 10): the message "Disable?" is displayed (or "Enable?" if the function has been disabled);
4. Press the **OK** button to enable or disable the beep;
5. Press the **MENU/ESC** button to exit the menu.

7.14 Default values (reset)

This resets all menu settings and programmed quantities back to the default values (with the exception of the language which remains as set).

To reset the default values, proceed as follows:

1. Press the **MENU/ESC** button (B14) to enter the menu;
2. Press < (B4) or > (B8) (fig. 9) until "Default values" appears on the display (B13);
3. Press the **OK** button (B12- fig. 10);
4. The message "Confirm?" is now displayed
5. Press the **OK** button to confirm and exit.

7.15 Statistics function

This displays statistics relating to the machine. To display, proceed as follows:

1. Press the **MENU/ESC** button (B14) to enter the menu;
2. Press < (B4) or > (B8) (fig. 9) until "Statistics" appears on the display (B13);
3. Press the **OK** button (B12- fig. 10);
4. By pressing < or > you can check:
 - how many coffees have been made;
 - the total number of cappuccinos and milk based coffees;
 - the total number of litres of water delivered;
 - how many times the machine has been descaled;

- how many times the water softener filter has been replaced.
5. Press the **MENU/ESC** button twice to exit the menu.

8. MAKING COFFEE

8.1 Selecting the coffee taste

The appliance is set by default to make coffee with a standard taste.

You can also choose one of these tastes:

Extra mild taste

Mild taste

Standard taste

Strong taste

Extra-strong taste

To change the taste, press the  button (B2- fig. 11) repeatedly until the required taste is displayed.



8.2 Selecting the quantity of coffee in the cup

The appliance is set by default to make a standard quantity of coffee. To select the quantity of coffee, press the  button (B15- fig. 12) until the message corresponding to the required quantity of coffee is displayed:

Coffee selected	Quantity in cup (fl.oz/ml)
MY COFFEE	Programmable: from ≈0,68/20 to ≈6,09/180
SHORT	≈1,35/40
STANDARD	≈2,03/60
LONG	≈3,04/90
EXTRA LONG	≈4,06/120

8.3 Customising the "my coffee" quantity

The appliance is set by default to automatically deliver 30 ml of "MY COFFEE". To modify this quantity, proceed as follows:

1. Place a cup under the coffee spouts (A7-fig. 13).
2. Press the  button (B15-fig.12) until "MY COFFEE" is displayed.
3. Press and hold the  button (B11-fig. 17) until the message "1 MY COFFEE Program quantity" is displayed. Then release the button;
4. As soon as the coffee in the cup reaches the required level, press the  button again.

The quantity of coffee in the cup has now been programmed.

8.4 Adjusting the coffee mill

The coffee mill is set by default to prepare coffee correctly and should not require regulating initially.

However, if after making the first few coffees you find that the coffee is either too weak and not creamy enough or delivery is too slow (a drop at a time), this can be corrected by adjusting the grinding adjustment dial (A5-fig. 14).

Please note!

The grinding adjustment dial must only be turned when the coffee mill is in operation.



If the coffee is delivered too slowly or not at all, turn one click clockwise towards "7".

For fuller bodied creamier coffee, turn one click anticlockwise towards "1" (do not turn more than one click at a time otherwise the coffee could be delivered

a drop at a time).

These adjustments will only be evident after at least 2 cups of coffee have been delivered. If this adjustment does not obtain the desired result, turn the dial another click.

8.5 Tips for a hotter coffee



For hotter coffee, you should:

- perform a rinse cycle by selecting the "Rinse" function in the settings menu (section "7.1 Rinsing");
- warm the cups with hot water using the hot water function (section "10.1 Hot water");
- set a hotter coffee temperature in the settings menu (section "7.10 Setting the temperature").



8.6 Making coffee using coffee beans

Important!

Do not use caramelised or candied coffee beans as they could stick to the coffee mill and make it unusable.

1. Fill the container (A3-fig. 15) with coffee beans.
2. Place under the coffee spouts (A7):
 - 1 cup, if you want to make 1 coffee (fig. 13);
 - 2 cups, if you want 2 coffees (fig. 16).
3. Lower the spouts as near as possible to the cup (fig. 16). This makes a creamier coffee.
4. Press the button corresponding to the number of coffees required (1 cup  -B11 or 2 cups  -B10).
5. Preparation begins. The amount of coffee selected is displayed together with a progress bar which gradually fills as preparation progresses.

Please note:

- While the machine is making coffee, delivery can be interrupted at any moment by pressing any button.
- At the end of delivery, to increase the quantity of coffee in the cup, just press (within 3 seconds) one of the coffee buttons ( or ) (fig. 17).

Once the coffee has been made, the appliance is ready to make the next drink.

Please note!

- Various alarm messages could be displayed while using the appliance (FILL TANK, EMPTY GROUNDS CONTAINER, etc.). Their meaning is explained in section "16. DISPLAYED MESSAGES".
- For hotter coffee, see section "8.5 Tips for a hotter coffee".
- If the coffee is delivered a drop at a time, too weak and not creamy enough or too cold, read the tips in section "17. TROUBLESHOOTING".



8.7 Making coffee using pre-ground coffee

Important!

- Never add pre-ground coffee when the machine is off or it could spread through the inside of the machine and dirty it. This could damage the appliance.
- Never use more than 1 level measure (C2) or it could dirty the inside of the coffee machine or block the funnel (A4).

Please note!

If you use pre-ground coffee, you can only make one cup of coffee at a time.

1. Press the  button (B2-fig. 11) until "Pre-ground" appears on the display (B13).
2. Open the pre-ground coffee funnel lid (A2).
3. Make sure the funnel (A4) is not blocked, then add one level measure of pre-ground coffee (fig. 18).
4. Place a cup under the coffee spouts.
5. Press the 1 cup coffee button  (B11).
6. Preparation begins. The amount of coffee selected is displayed together with a progress bar which gradually fills as preparation progresses.

Please note!

If "Energy Saving" mode is active, you may have to wait a few seconds before the first coffee is delivered.

8.8 Making LONG coffee using coffee beans

Prepare the appliance following the instructions in the section "8.6 Making coffee using coffee beans", then press the  button (B9-fig. 19): "LONG COFFEE FUNCTION" appears on the display (B13), together with a progress bar which fills gradually as preparation proceeds.

8.9 Making LONG coffee using pre-ground coffee



Follow the instructions in points 1, 2, 3 and 4 of the section “8.7 Making coffee using pre-ground coffee”, then press the **LONG**  button (B9- fig. 19).

The appliance starts making coffee and “LONG COFFEE FUNCTION” appears on the display (B13), together with a progress bar which fills gradually as preparation proceeds. Halfway through preparation, the message “ADD PRE-GROUND COFFEE, Press OK” appears. Add one level measure of pre-ground coffee and press **OK** (B12-fig. 10).

Preparation resumes and the appliance displays a progress bar which fills gradually as preparation proceeds.

8.10 Customising the LONG coffee quantity

The appliance is set by default to automatically deliver about 6,09 fl.oz/180ml of LONG coffee. To modify these settings, proceed as follows:

1. Place a sufficiently large cup or glass under the coffee spouts (A7- fig. 13).
2. Press and hold the **LONG**  button (B9-fig.19) until “Program quantity” is displayed.
3. Release the **LONG**  button. The appliance starts delivering coffee;
4. As soon as the coffee in the cup reaches the required level, press the **LONG**  button again.

The quantity of coffee in the cup has now been programmed.

Please note!

If the programme uses pre-ground coffee, the appliance will prompt you to add a second level measure of coffee (C2).

9. MAKING CAPPUCCINOS AND MILK-BASED COFFEES

Please note!

- To avoid producing milk with poor froth or large bubbles, always clean the milk container lid (D2) and hot water/steam connection nozzle (A8) as described in sections “9.5 Cleaning the milk container after every use”, “11.10 Cleaning the milk container” and “11.11 Cleaning the hot water/steam connection nozzle”

9.1 Filling and attaching the milk container



1. Remove the lid (D2- fig. 20);
2. Fill the milk container (D3) with a sufficient quantity of milk, not exceeding the MAX level marked on the container (fig. 21). Each mark on the side of the container corresponds to about 3,38 fl.oz/100 ml of milk.

Please note!

- For a denser more even froth, you must use skimmed or partially skimmed milk at refrigerator temperature (about 5°C).
 - If “Energy Saving” mode is enabled, you may have to wait a few seconds before the drink is delivered.
3. Make sure the milk intake tube (D4) is correctly inserted in the bottom of the milk container lid (fig. 22).
 4. Place the lid back on the milk container.
 5. Extract the cappuccino maker/hot water spout (C6) by pressing the button (C7) on the spout (fig. 23A and B).
 6. Attach the milk container to the connection nozzle (A8) and push as far as it will go (fig. 24). The machine emits a beep (if the beep function is enabled).
 7. Place a sufficiently large cup under the coffee spouts (A7) and frothed milk spout (D5). Adjust the length of the milk spout. To move it nearer the cup, simply pull it downwards (fig. 25).
 8. Follow the instructions below for each function.

9.2 Adjusting the amount of froth

Turn the froth adjustment dial (D1) to adjust the amount of froth on the milk delivered while making cappuccinos and milk-based coffees.

Dial position	Description	Recommended for . . .
	No froth	CAFFELATTE / MILK (hot milk)
	Min. froth	LATTE MACCHIATO/ FLAT WHITE
	Max. froth	CAPPUCCINO / MILK (frothed milk)/ ESPRESSO MACCHIATO

9.3 Making cappuccinos and milk-based coffees automatically

The CAPPUCCINO (B3), CAFFELATTE (B4) and LATTE MACCHIATO (B5) buttons on the control panel (B) enable these drinks to be prepared automatically. Proceed as follows:

1. Fill the milk container (D) and attach it as described above (fig. 24).
2. Turn the froth adjustment dial (D1) on the milk container lid (D2) to the position corresponding to the required froth.
3. Press the button corresponding to the required drink. The name of the drink selected is displayed together with a progress bar which gradually fills as preparation progresses.

4. After a few seconds, frothed milk is delivered from the milk spout (D5) into the cup below. Then the machine automatically makes the coffee after delivering the milk.

9.4 Preparing “MILK MENU” drinks

Besides the drinks described above, the appliance automatically prepares MILK (hot milk), FLAT WHITE, ESPRESSO MACCHIATO and MY MILK (customisable).

To prepare one of these drinks, simply proceed as follows:

1. Fill the milk container (D) and attach it as described above (fig. 24).
2. Turn the froth adjustment dial (D1) on the milk container lid (D2) to the position corresponding to the required froth.
3. Press the **MILK MENU** button (B6).
4. Press < (B4) or > (B8) (fig. 9) until the drink to be programmed appears on the display (B13) (MILK, FLAT WHITE, ESPRESSO MACCHIATO or MY MILK).
5. Press the **OK** button (B12- fig. 10) to start delivery.
6. After a few seconds, frothed milk is delivered from the milk spout (D5) into the cup below. For drinks with coffee, the machine automatically makes the coffee after delivering the milk.

Please note: general indications when preparing all milk-based drinks

- If you want to interrupt preparation during delivery, press the corresponding button.
- At the end of delivery, to increase the quantity of milk or coffee in the cup, just press and hold (within 3 seconds) the button corresponding to the drink being made.
- Do not leave the milk container out of the refrigerator for long periods. The warmer the milk (5°C is ideal), the poorer the quality of froth produced.

9.5 Cleaning the milk container after every use

Important! Danger of burns

When cleaning the internal tubes of the milk container (D4), a little hot water and steam leak out of the frothed milk spout (D5). Avoid contact with splashes of water.

“SET DIAL TO CLEAN” flashes on the display (B13) each time you use a milk function. To eliminate all milk residues, proceed as follows:

1. Leave the milk container in the machine (you do not need to empty it);
2. Place a cup or other recipient under the frothed milk spout (D5).
3. Turn the froth adjustment dial (D1) to “CLEAN” (fig. 26). A progress bar appears and gradually fills as the operation proceeds together with “Cleaning underway”. Cleaning stops automatically.

4. Turn the dial back to one of the froth selections.
5. Remove the milk container (D) and always clean the hot water/steam connection nozzle (A8) with a sponge (fig. 27).

Please note!

- To prepare a number of cappuccinos or milk-based coffees, clean the milk container after you have prepared the last drink only.
- The milk container can be kept in the refrigerator.
- In some cases, to clean you must wait for the appliance to heat up.

9.6 Programming the quantity of coffee and milk in the cup for the CAPPUCCINO, CAFFELATTE and LATTE MACCHIATO buttons

The appliance is set by default to automatically deliver standard quantities. To change these quantities, proceed as follows:

1. Place a cup under the coffee spouts (A7) and milk spout (D5).
2. Press and hold one of the buttons until the name of the drink and “PROGRAM MILK” are displayed.
3. Release the button. The appliance starts delivering milk.
4. Once the required quantity of milk has been delivered into the cup, press the button again.
5. The appliance stops delivering milk and, if required for the drink being prepared, after a few seconds the coffee is delivered into the cup. The name of the drink and “PROGRAM COFFEE” are displayed.
6. Once the required quantity of coffee has been delivered into the cup, press the button again. Coffee delivery stops. The machine is now reprogrammed with the new milk and coffee quantities.

9.7 Programming the quantity of coffee and milk in the cup for MILK MENU drinks

The appliance is set by default to automatically deliver standard quantities. To change these quantities, proceed as follows:

1. Press the **MILK MENU** button (B6).
2. Press < (B4) or > (B8) (fig. 9) until the drink to be programmed appears on the display (B13) (MILK, FLAT WHITE, ESPRESSO MACCHIATO or MY MILK).
3. Press and hold the **OK** button (B12- fig. 10) until the name of the drink and “PROGRAM MILK” appear.
4. Release the button. The appliance starts delivering milk.
5. Once the required quantity of milk has been delivered into the cup, press the **OK** button.
6. The appliance stops delivering milk and, if required for the drink being prepared, after a few seconds the coffee is delivered into the cup. The name of the drink and “PROGRAM COFFEE” are displayed.

7. Once the required quantity of coffee has been delivered into the cup, press the **OK** button again. Coffee delivery stops.

The machine is now reprogrammed with the new milk and coffee quantities.

10. DELIVERING HOT WATER AND STEAM



Important! Danger of burns.



Do not leave the appliance unattended while hot water or steam is being delivered. The cappuccino maker/hot water spout (C6) becomes hot during delivery. Hold by the handle only.



Please note!



If “Energy Saving” is active, you may have to wait a few seconds before hot water and steam are delivered.

10.1 Hot water

1. Make sure the cappuccino maker/hot water spout (C6) is attached correctly.
2. Place a cup under the spout (as close as possible to avoid splashes).
3. Press the  button (B7- fig. 6). “HOT WATER” appears on the display (B13), together with a progress bar which fills gradually as preparation proceeds.
4. The machine delivers about 8,45 fl.oz/250ml of hot water, then delivery stops automatically. To interrupt delivery of hot water manually, press the  button again.

10.2 Changing the quantity of water delivered automatically



The machine is set by default to automatically deliver 8,45 fl.oz/250ml of hot water. To modify these quantities, proceed as follows:

1. Position a cup under the cappuccino maker/hot water spout (C6).
2. Press and hold the  button (B7-fig. 6) until “HOT WATER Program quantity” appears on the display (B13), then release the  button.
3. When the hot water in the cup reaches the required level, press the  button again.

The machine is now reprogrammed with the new quantity.

10.3 Steam delivery

1. Make sure the cappuccino maker/hot water spout (C6) is attached correctly.
2. Fill a container with the liquid to be heated/frothed and immerse the cappuccino maker/hot water spout in the liquid.

3. Press the  button (B8). After a few seconds, the steam to heat the liquid comes out of the cappuccino maker/hot water spout and “STEAM” is displayed.
4. When the required temperature is obtained, interrupt steam delivery by pressing the  button again. (You should not discharge steam for more than 3 minutes at a time).



Important!



Always stop steam delivery before extracting the container containing the liquid to avoid burns from splashes.

10.4 Tips for using steam to froth milk

- When choosing the size of the container, bear in mind that the liquid doubles or triples in volume.
- For a richer denser froth, use skimmed or partially skimmed milk at refrigerator temperature (about 5°C).
- For a creamier froth, rotate the container with slow movements in an upward direction.
- To avoid milk with poor froth or large bubbles, always clean the spout as described in the following section.

10.5 Cleaning the spout after use

Always clean the cappuccino maker/hot water spout (C6) after use to avoid the build-up of milk residues and prevent it from clogging.

1. Place a container under the cappuccino maker/hot water spout and press the  button (B7-fig. 6) to deliver a little water. Stop the flow of hot water by pressing the  button again.
2. Wait a few minutes for the cappuccino maker/hot water spout to cool down, then press the button (C7) to remove it (fig. 28A). Hold the spout with one hand and with the other, turn the cappuccino maker/hot water spout anti-clockwise (fig. 28B) and pull downwards to remove.
3. Also remove the steam nozzle by pulling it downwards (fig. 29).
4. Check the hole shown by the arrow in fig. 30 is not blocked. If necessary, clean with a pin.
5. Wash all parts of the cappuccino maker/hot water spout thoroughly with a sponge and warm water.
6. Reinsert the nozzle and replace the cappuccino maker on the nozzle, pushing it upwards and turning it until it is attached.

11. CLEANING

11.1 Cleaning the machine

The following parts of the machine must be cleaned regularly:

- the appliance's internal circuit;
- coffee grounds container (A10);
- drip tray (A12) and condensate tray (A9);
- water tank (A16);
- coffee spouts (A7);
- pre-ground coffee funnel (A4);
- infuser (A15), accessible after opening the service door (A14);
- milk container (D);
- cappuccino maker/hot water spout (C6 - section "10.5 Cleaning the spout after use");
- hot water/steam connection nozzle (A8);
- display (B).

Important!

- Do not use solvents, abrasive detergents or alcohol to clean the coffee machine. With De'Longhi superautomatic coffee machines, you need not use chemical products to clean the machine.
- None of the components of the appliance can be washed in a dishwasher with the exception of the milk container (D).
- Do not use metal objects to remove encrustations or coffee deposits as they could scratch metal or plastic surfaces.

11.2 Cleaning the machine's internal circuit

If the appliance is not used for more than 3/4 days, before using it again, we strongly recommend switching it on and:

- performing 2-3 rinse cycles (see section "7.1 Rinsing");
- deliver hot water for a few seconds by pressing the ☞ button (B7- fig. 6).

Please note!

After cleaning, it is normal for the grounds container (A10) to contain water.

11.3 Cleaning the coffee grounds container

When "EMPTY GROUNDS CONTAINER" appears on the display (B13), the grounds container must be emptied and cleaned. The appliance cannot be used to make coffee until you have cleaned the grounds container (A10). Even if not full, the empty grounds container message is displayed 72 hours after the first coffee has been prepared. For the 72 hours to be calculated correctly, the machine must never be turned off with the main switch (A19).

Important! Danger of burns

If you make a number of cappuccinos one after the other, the metal cup tray (A11) becomes hot. Wait for it to cool down before touching it and handle it from the front only.

To clean (with the machine on):

- Remove the drip tray (A12) (fig. 31), empty and clean.
- Empty the grounds container (A10) and clean thoroughly to remove all residues left on the bottom. This can be done using the spatula on the brush (C5) provided.
- Check the condensate tray (A9) and empty if necessary (fig. 32).

Important!

When removing the drip tray, the grounds container must be emptied, even if it contains few grounds.

If this is not done, when you make the next coffees, the grounds container may fill up more than expected and clog the machine.

11.4 Cleaning the drip tray and condensate tray

Important!

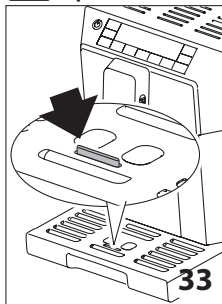

The drip tray (A12) is fitted with a level indicator (A13 - red) showing the level of water it contains (fig. 33). Before the indicator protrudes from the cup tray (A11), the drip tray must be emptied and cleaned, otherwise the water may overflow the edge and damage the appliance, the surface it rests on or the surrounding area.

To remove the drip tray:

1. Remove the drip tray and grounds container (fig. 31);
2. Empty the drip tray and grounds container (A10) and wash them;
3. Check the condensate tray (A9 - fig. 32) and empty if necessary;
4. Replace the drip tray and grounds container.

11.5 Cleaning the inside of the coffee machine

Danger of electric shock!

Before cleaning internal parts, the machine must be turned off (see section "6. TURNING THE APPLIANCE OFF") and unplugged from the mains power supply. Never immerse the coffee machine in water.

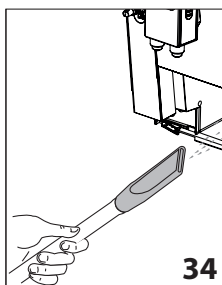

1. Check regularly (about once a week) that the inside of the appliance (accessible after removing the drip tray (A12) is not dirty. If necessary, remove coffee deposits with the brush (C5) supplied and a sponge.

- Remove all the residues with a vacuum cleaner (fig. 34).

11.6 Cleaning the water tank

- Clean the water tank (A16) regularly (about once a month) and whenever you replace the water softener filter (C4) (if provided) with a damp cloth and a little mild washing up liquid.
- Remove the filter (if present) and rinse with running water.
- Replace the filter (if provided), fill the tank with fresh water and replace the tank.
- (Models with water softener filter only) Deliver about 3,38 fl.oz/100 ml of water.

11.7 Cleaning the coffee spouts

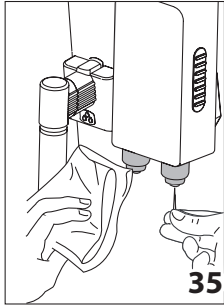

- Clean the coffee spouts (A7) regularly with a sponge or cloth (fig. 35).
 - Check that the holes in the coffee spouts are not blocked.
- If necessary, remove coffee deposits with a toothpick (fig. 35).

11.8 Cleaning the pre-ground coffee funnel

Check regularly (about once a month) that the pre-ground coffee funnel (A4) is not blocked. If necessary, remove coffee deposits with the brush (C5) supplied.

11.9 Cleaning the infuser

The infuser (A15) must be cleaned at least once a month.



Important!

The infuser may not be extracted when the machine is on.

- Make sure the machine is correctly turned off (see section "6. TURNING THE APPLIANCE OFF").
- Remove the water tank (A16- fig. 3).
- Open the infuser door (A14- fig. 36) on the right side of the appliance.

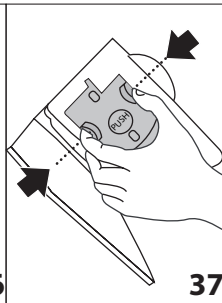
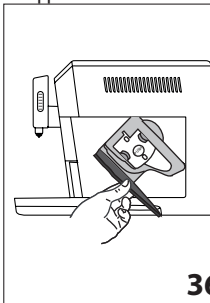

- Press the two coloured release buttons inwards and at the same time pull the infuser outwards (fig. 37);
- Soak the infuser in water for about 5 minutes, then rinse under the tap.



Important!

RINSE WITH WATER ONLY

NO WASHING UP LIQUID - NO DISH WASHER

Clean the infuser without using washing up liquid as it could be damaged.

- Use the brush (C5) to remove any coffee residues left in the infuser housing, visible through the infuser door.
- After cleaning, replace the infuser by sliding it onto the internal support (fig. 38), then push the PUSH symbol fully in until it clicks into place.

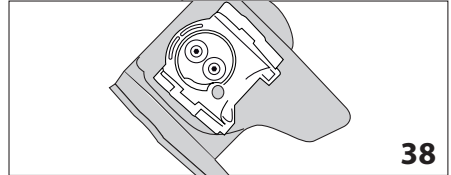

Please note!

If the infuser is difficult to insert, before insertion, adapt it to the right size by pressing the two levers shown in fig. 39.

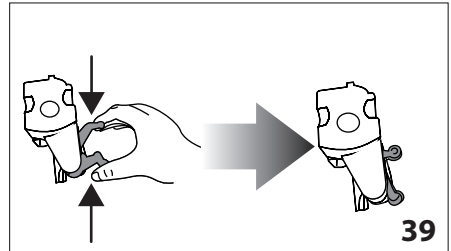

- Once inserted, make sure the two coloured buttons have snapped out (fig. 40).

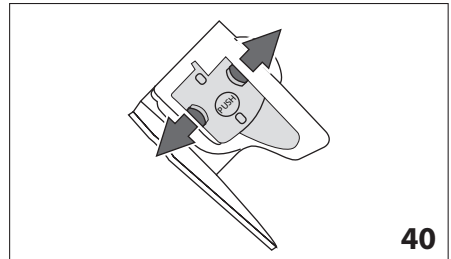

- Close the infuser door.
- Put the water tank back.

11.10 Cleaning the milk container

To keep the frother efficient, clean the milk container (D) every two days as described below:

1. Remove the lid (D2).
2. Remove the milk spout (D5) and intake tube (D4).
3. Turn the froth regulator (D1) to the "INSERT" position (fig. 41) and pull it off upwards.

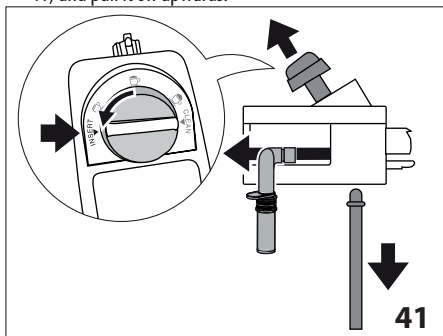

4. Wash all the components thoroughly with hot water and mild washing-up liquid. All components are dishwasher safe, placing them in the top basket of the dishwasher. Make sure there are no milk residues on the hollow and groove under the dial (fig. 42). If necessary, scrape the groove with a toothpick.

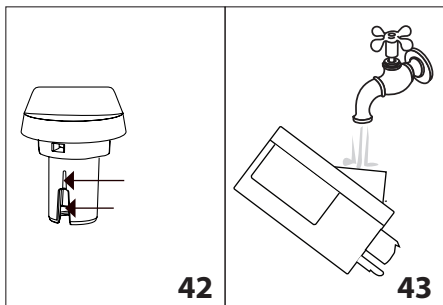

5. Rinse inside the froth adjustment dial seat with running water (fig. 43).
6. Check that the intake tube and spout are not clogged with milk residues.
7. Replace the dial (in correspondence to the word "INSERT"), spout and milk intake tube.
8. Place the lid back on the milk container.

11.11 Cleaning the hot water/steam connection nozzle

Each time you prepare milk, clean the connection nozzle (A8) with a sponge to remove milk residues from the gaskets (fig. 27).

12. DESCALING

Descal the machine when the message "DESCALE" flashes on the display (B13).

⚠ Important!

- Before use, read the instructions and the labelling on the descaler pack.
- You should use De'Longhi descaler only. Using unsuitable descaler and/or performing descaling incorrectly may result in faults not covered by the manufacturer's guarantee.

1. Turn the appliance on and wait until it is ready for use;
2. Press the MENU/ESC button (B14) to enter the menu;
3. Press < (B4) or > (B8) (fig. 9) until "Descal" is displayed;
4. Select by pressing the OK button (B12- fig. 10): the message "Descal Confirm?" is displayed;
5. Press the OK button again to confirm. "EMPTY DRIP TRAY" is displayed, alternating with "REMOVE FILTER" (if the filter is present) and "Add descaler Press OK";
6. Empty the water tank (A16) completely and remove the water softener filter (C4), if present. Empty the drip tray (A12 - fig. 31) and grounds container (A10), then put them back in the appliance.

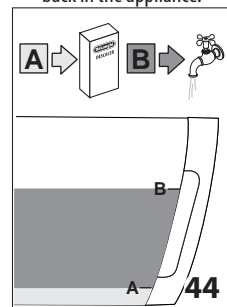

7. Pour the descaler into the tank up to level A (corresponding to a 3,38 fl.oz/ 100ml pack) marked on the inner surface of the tank (fig. 44), then add water (33,81 fl.oz/1 litre) up to level B (fig. 44) and put the water tank back.

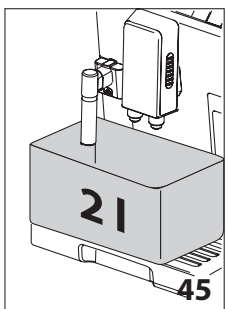

8. Place an empty container with a minimum capacity of 67,63 fl.oz/2.0 litres under the coffee spouts (A7) and hot water spout (C6) (fig. 45);

⚠ Important! Danger of burns

Hot water containing acid flows out from the coffee and hot water spouts. Take care to avoid contact with splashes of this solution.

9. Press the **OK** button to confirm that you have added the descaler solution. The message "Descal underway" is dis-

played and the descaling procedure begins. The descaler liquid comes out of the coffee spouts and hot water spout and a series of rinses and pauses is performed to remove limescale deposits from inside the machine;

After about 25 minutes, descaling stops and the messages "RINSING" and "FILL TANK" alternate on the display;

10. The appliance is now ready for rinsing through with clean water. Empty the container used to collect the descaler solution. Extract the water tank, empty, rinse under running water, fill with fresh water up to the MAX level and put back in the appliance: "RINSING, Press OK" is displayed;
11. Place the container used to collect the descaler solution empty under the coffee spouts and hot water spout (fig. 45);
12. Press the **OK** button to start rinsing. Hot water flows out of the spouts and the message "RINSING Please wait" is displayed.
13. When the water tank is empty, the messages "RINSING", "FILL TANK" and "REPLACE FILTER" (if previously removed) alternate on the display. Empty the container used to collect the rinsing water;
14. Remove the water tank, replace the water softener filter (if previously removed), fill the tank up to the MAX level with fresh water and insert it in the appliance. "RINSING Press OK" appears on the display;
15. Place the container used to collect the rinsing water empty under the hot water spout (fig. 45);
16. Press the **OK** button to resume rinsing. Rinsing begins again from the hot water spout only and the message "RINSING Please wait" is displayed;
17. When it finishes, the message "Rinsing complete, Press OK" is displayed;
18. Press the **OK** button. The message "FILL TANK" is displayed;
19. Empty the drip tray, remove and top up the water tank with fresh water to the MAX level and put back in the machine.

Descaling is complete.

i Please note!

- If the descaling cycle is not completed correctly (e.g. no electricity) we recommend repeating the cycle;
- After descaling, it is normal for the grounds container (A10) to contain water.

13. SETTING WATER HARDNESS

The DESCALE message appears on the display after a period of time established according to water hardness.

The machine is set by default for a hardness value of 4. The machine can also be programmed according to the hardness of the mains water in the various regions so that the machine needs to be descaled less often.

13.1 Measuring water hardness

1. Remove the "TOTAL HARDNESS TEST" indicator paper (C1) from its pack (attached to the English instructions).
2. Immerse the paper completely in a glass of water for one second.
3. Remove the paper from the water and shake lightly. After about a minute, 1, 2, 3, or 4 red squares form, depending on the hardness of the water. Each square corresponds to one level.

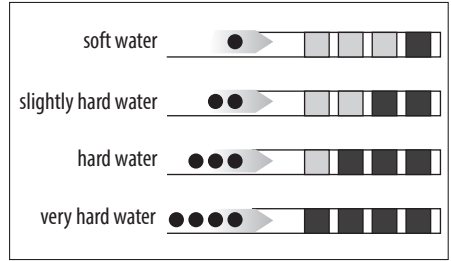

13.2 Setting water hardness

1. Press the **MENU/ESC** (B14) button to enter the menu.
2. Press < (B4) or > (B8) (fig. 9) and select "Water hardness".
3. Confirm the selection by pressing the **OK** button (B12 - fig. 10).
4. Press < or > repeatedly to set the level as measured by the indicator paper (see previous section).
5. Press the **OK** button to confirm the setting.
6. Press the **MENU/ESC** button to exit the menu.

The machine is now reprogrammed with the new water hardness setting.

14. WATER SOFTENER FILTER

Certain models are fitted with a water softener filter (C4). If this is not the case with your model, you are recommended to purchase one from De'Longhi Customer Services.

To use the filter correctly, follow the instructions below.

14.1 Installing the filter

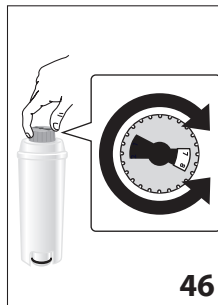

1. Remove the filter (C4) from the packaging.
2. Turn the date indicator disk (see fig. 46) until the next two months of use are displayed.

i Please note

The filter lasts about two months if the appliance is used normally. If the coffee machine is left unused with the filter installed, it will last a maximum of three weeks.

- To activate the filter, run tap water through the hole in the filter as shown in the figure until water comes out of the openings at the side for more than a minute (fig. 47).

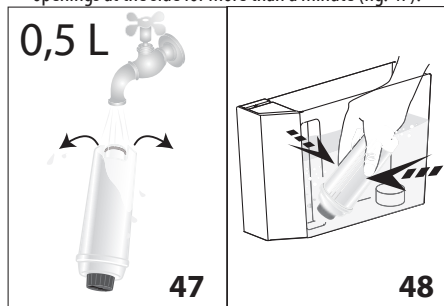

- Extract the tank (A16) from the appliance and fill with water.
- Insert the filter in the water tank and immerse it completely for about ten seconds, sloping it and pressing it lightly to enable the air bubbles to escape (fig. 48).
- Insert the filter in the filter housing (A17- fig. 49A) and press as far as it will go.
- Close the tank with the lid (A18- fig. 49B), then replace the tank in the machine.

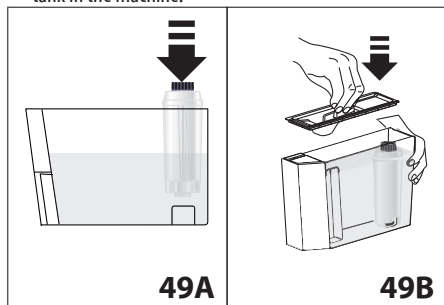

When you install the filter, you must notify the appliance of its presence.

- Press the **MENU/ESC** button (B14) to enter the menu;
- Press < (B4) or > (B8) (fig. 9) until “Install filter” appears on the display (B13).
- Press the **OK** button (B12- fig. 10).
- “Install?” is displayed.
- Press the **OK** button to confirm the selection. “HOT WATER Press OK” is displayed.
- Position a container under the hot water spout (C6) (min. capacity: 17 fl.oz/500 ml).
- Press the **OK** button to confirm the selection. The appliance begins hot water delivery and the message “Please wait” is displayed.
- After the flow of hot water stops, the appliance automatically resets to “Ready for coffee” status.

The filter is now active and you can use the coffee machine.

14.2 Replacing the filter

When “REPLACE FILTER” appears on the display (B13), after two months (see date indicator) or when the appliance has not been used for 3 weeks, you should replace the filter (C4):

- Extract the tank (A16) and exhausted filter;
- Take the new filter out of its packet and proceed as illustrated in points 2, 3, 4, 5, 6 and 7 in the previous section.
- Position a container with a minimum capacity of 17 fl.oz/ 500ml under the hot water spout (C6).
- Press the **MENU/ESC** button (B14) to enter the menu;
- Press < (B4) or > (B8) (fig. 9) until “Replace filter” is displayed.
- Press the **OK** button (B12- fig. 10);
- The message “Confirm?” is now displayed
- Press the **OK** button to confirm the selection;
- “HOT WATER Press OK” is displayed;
- Press the **OK** button to confirm the selection. The appliance begins hot water delivery and the message “Please wait” is displayed.
- After the flow of hot water stops, the appliance automatically resets to “Ready for coffee” status.

The new filter is now active and you can use the coffee machine.

14.3 Removing the filter

If you want to use the appliance without the filter (C4), you must remove it and notify the appliance of its removal.

Proceed as follows:

- Extract the tank (A16) and exhausted filter;
- Press the **MENU/ESC** button (B14) to enter the menu;
- Press < (B4) or > (B8-fig. 9) until “Install filter, Enabled” is displayed;
- Press the **OK** button (B12- fig. 10);
- “Disable?” appears on the display;
- Press the **OK** button to confirm and the **MENU/ESC** button to exit the menu.

15. TECHNICAL DATA

Voltage:	120 V~ 60 Hz max. 10 A
Power:	1250 W
Pressure:	1,5 MPa (15 bar)
Water tank capacity:	2 L
Size LxDxH:	260x470x365 mm
Cord length:	1750 mm
Weight:	11 kg
Beans container capacity:	400 g

16. DISPLAYED MESSAGES

DISPLAYED MESSAGE	POSSIBLE CAUSE	SOLUTION
FILL TANK	Insufficient water in the tank (A16).	Fill the tank with water and/or insert it correctly, pushing it as far as it will go until it clicks into place.
EMPTY GROUNDS CONTAINER	The grounds container (A10) is full.	Empty the grounds container and drip tray (A12), clean and replace (fig. 31). Important: when removing the drip tray, the grounds container MUST be emptied, even if it contains few grounds. If this is not done, when you make the next coffees, the grounds container may fill up more than expected and clog the machine.
GROUND TOO FINE ADJUST MILL	The grinding is too fine and the coffee is delivered too slowly or not at all.	Repeat coffee delivery and turn the grinding adjustment dial (A5, fig. 14) one click clockwise towards "7" while the coffee mill is in operation. If after making at least 2 coffees delivery is still too slow, repeat the correction procedure, turning the grinding adjustment dial another click (section "8.4 Adjusting the coffee mill"). If the problem persists, make sure the water tank (A16) is fully inserted, press the ☉ button (B7-fig. 6) and deliver a little water from the spout (C6).
	If the water softener filter (C4) is present, an air bubble may have been released inside the circuit, obstructing delivery.	Insert hot cappuccino maker/water spout (C6) in the appliance and deliver a little water until the flow becomes regular.
INSERT GROUNDS CONTAINER	After cleaning, the grounds container has not been replaced (A10).	Remove the drip tray (A12-fig. 31) and insert the grounds container.
ADD PRE-GROUND COFFEE	With the "pre-ground coffee" function selected, pre-ground coffee has not been poured into the funnel (A4).	Place pre-ground coffee in the funnel or deselect the "pre-ground" function (fig. 18).
DESCALE	The machine must be descaled.	The descaling procedure described in section "12. DESCALING" needs to be performed as soon as possible.
REDUCE COFFEE AMOUNT	Too much coffee has been used.	Select a milder taste by pressing the  button (B2- fig. 11) or reduce the quantity of pre-ground coffee.
FILL BEANS CONTAINER	The coffee beans have run out.	Fill the beans container (A3-fig. 15).
	The pre-ground coffee funnel (A4) is clogged.	Empty the funnel with the help of the brush (C5) as described in section "11.8 Cleaning the pre-ground coffee funnel".
INSERT INFUSER ASSEMBLY	The infuser has not been replaced after cleaning (A15).	Insert the infuser as described in section "11.9 Cleaning the infuser".



INSERT TANK	The tank (A16) is not correctly in place.	Insert the tank correctly and press as far as it will go.
GENERAL ALARM	The inside of the appliance is very dirty.	Clean the inside of the appliance thoroughly, as described in section "11. CLEANING". If the message is still displayed after cleaning, contact a service centre.
EMPTY CIRCUIT FILL CIRCUIT <i>alternating with</i> HOT WATER Press OK	The water circuit is empty	Press OK (B12- fig. 10) to deliver water from the spout (C6) until it flows out normally. If the problem persists, make sure the water tank (A16) is fully inserted.
REPLACE FILTER	The water softener filter (C4) is exhausted.	Replace the filter or remove it as described in section "14. WATER SOFTENER FILTER".
SET DIAL TO CLEAN	Milk has been delivered recently and the tubes inside the milk container must be cleaned (D).	Turn the froth adjustment dial (D1) to the CLEAN position (fig. 26).
INSERT WATER SPOUT	The cappuccino maker/hot water spout (C6) is not inserted or is inserted incorrectly	Insert the spout as far as it will go.
INSERT MILK CONTAINER	The milk container (D) is not inserted correctly.	Insert the milk container (fig. 24) as far as it will go.

17. TROUBLESHOOTING

Below is a list of some of the possible malfunctions.

If the problem cannot be resolved as described, contact Customer Services.

PROBLEM	POSSIBLE CAUSE	SOLUTION
The coffee is not hot.	The cups were not preheated.	<ul style="list-style-type: none"> Enable the cup warmer (A6), leave the cups at least 20 minutes to warm up. Warm the cups by rinsing them with hot water (Please note: you can use the hot water function).
	The internal circuits have cooled down because 2/3 minutes have elapsed since the last coffee was made.	Before making the coffee, heat the infuser by rinsing using the "rinse" function (see section "7.1 Rinsing").
	A low coffee temperature is set.	Set a hotter coffee temperature (see section "7.10 Setting the temperature").
The coffee is weak or not creamy enough.	The coffee is ground too coarsely.	Turn the grinding adjustment dial (A5) one click anticlockwise towards "1" while the coffee mill is in operation (fig. 14). Continue one click at a time until coffee delivery is satisfactory. The effect is only visible after delivering 2 coffees (see section "8.4 Adjusting the coffee mill").
	The coffee is unsuitable.	Use pre-ground coffee for espresso machines.

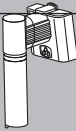
<p>The coffee is delivered too slowly or a drop at a time.</p>	<p>The coffee is ground too finely.</p>	<p>Turn the grinding adjustment dial (A5) one click clockwise towards "7" while the coffee mill is in operation (fig. 14). Continue one click at a time until coffee delivery is satisfactory. The effect is only visible after delivering 2 coffees (see section "8.4 Adjusting the coffee mill").</p>
<p>Coffee does not come out of one or both of the spouts.</p>	<p>The coffee spouts (A7) are blocked.</p>	<p>Clean the spouts with a toothpick (see section "11.7 Cleaning the coffee spouts").</p>
<p>The appliance does not come on</p>	<p>It is not plugged into the mains socket.</p>	<p>Plug into the mains socket (fig. 1).</p>
	<p>The main switch (A19) is not turned on.</p>	<p>Press the main switch (fig. 2).</p>
<p>The infuser cannot be extracted</p>	<p>The appliance has not been turned off correctly</p>	<p>Turn the appliance off by pressing the  button (B1-fig. 8) (section "6. TURNING THE APPLIANCE OFF").</p>
 <p>The milk does not come out of the milk spout (D5)</p> <p>The milk contains large bubbles and squirts out of the milk spout (D5) or there is little froth</p>	<p>The milk container lid (D2) is dirty.</p>	<p>Clean the milk container lid as described in section "11.10 Cleaning the milk container".</p>
	<p>The milk is not cold enough or is not semi-skimmed.</p>	<p>Use skimmed or semi-skimmed milk at refrigerator temperature (about 5° C). If the result is not as you wished, try changing brand of milk.</p>
	<p>The froth adjustment dial (D1) is incorrectly adjusted.</p>	<p>Adjust following the instructions in section "9. MAKING CAPPUCCINOS AND MILK-BASED COFFEES".</p>
	<p>The milk container lid (D2) or froth adjustment dial (D1) are dirty.</p>	<p>Clean the milk container lid and dial as described in section "11.10 Cleaning the milk container".</p>
 <p>The milk contains large bubbles and squirts out of the milk spout or there is little froth.</p>	<p>The hot water/steam connection nozzle (A8) is dirty.</p>	<p>Clean the connection nozzle as described in section "11.11 Cleaning the hot water/steam connection nozzle".</p>
	<p>The cappuccino maker/ hot water spout (C6) is dirty.</p>	<p>Clean as described in section "10.5 Cleaning the spout after use".</p>

