

CONTENTS

1. FUNDAMENTAL SAFETY WARNINGS.....	7
2. SAFETY WARNINGS	8
2.1 Symbols used in this Instruction for Use.....	8
2.2 Designated use.....	8
2.3 Instruction for Use.....	8
3. INTRODUCTION.....	8
3.1 Letters in brackets.....	8
3.2 Troubleshooting and repairs.....	8
3.3 Download the App!.....	9
4. DESCRIPTION.....	9
4.1 Description of the appliance (page 3 - A)	9
4.2 Description of the homepage (main screen) (page 2 - B).....	9
4.3 Description of the accessories.....	9
4.4 Description of the milk container	9
4.5 "Mix carafe" description	9
5. BEFORE USE.....	10
5.1 Checking the appliance	10
5.2 Installing the appliance.....	10
5.3 Connecting the appliance.....	10
6. TURNING THE APPLIANCE ON.....	10
7. TURNING THE APPLIANCE OFF	11
8. MENU SETTINGS	11
8.1 Rinsing	11
8.2 Descaling	11
8.3 Water filter	11
8.4 Beverages settings	11
8.5 Set time	11
8.6 Auto-start	11
8.7 Auto-off (standby)	12
8.8 Cup warmer	12
8.9 Energy saving	12
8.10 Coffee temperature	12
8.11 Water hardness	12
8.12 Selecting the language	12
8.13 Beep	12
8.14 Cup light	13
8.15 Background	13
8.16 Bluetooth	13
8.17 Emptying the circuit	13
8.18 Default values	13
5.1 Statistics	14
9. MAKING COFFEE.....	14
9.1 Selecting the coffee aroma.....	14
9.2 Selecting the coffee quantity.....	14
9.3 Adjusting the coffee mill.....	14
9.4 Tips for a hotter coffee.....	14
9.5 Making coffee using coffee beans	14
9.6 Making coffee using pre-ground coffee.....	15
10. MAKING CAPPUCCINOS AND MILK-BASED COFFEES	15
10.1 Filling and attaching the milk container.....	15
10.2 Adjusting the amount of froth.....	16
10.3 Making cappuccinos and milk-based coffees automatically	16
10.4 Cleaning the milk container after use	16
11. TEA FUNCTION	16
12. DELIVERING HOT WATER	17
13. STEAM DELIVERY	17
13.1 Tips for using steam to froth milk.....	17
13.2 Clean the hot water/steam spout after use ..	17
14. MAKING HOT CHOCOLATE	18
15. MAKING COLD BEVERAGES.....	18
6.1 making cold coffee	18
8.1 Making cold milk froth	20
16. CUSTOMISING THE BEVERAGES	20
17. MEMORISING YOUR PERSONAL PROFILE....	20
18. CLEANING.....	21
8.1 Cleaning the machine	21
8.2 Cleaning the machine's internal circuit	21
2.1 Cleaning the coffee grounds container	21
4.1 Cleaning the drip tray.....	21
18.1 Cleaning the inside of the coffee machine ..	22
18.2 Cleaning the water tank.....	22
18.3 Cleaning the coffee spouts	22
18.4 Cleaning the pre-ground coffee funnel	22
18.6 Cleaning the milk container	23
18.7 Cleaning the hot water/steam connection nozzle.....	23
18.8 Cleaning the "Mix Carafe" (E).....	23
19. DESCALE.....	23
20. SETTING WATER HARDNESS	25
20.1 Measuring water hardness	25
20.2 Setting water hardness	25
21. WATER SOFTENER FILTER	25
21.1 Installing the filter	25
21.2 Replacing the filter.....	26
21.3 Removing the filter	26
22. TECHNICAL DATA.....	26
23. DISPOSING OF THE APPLIANCE	26
24. DISPLAYED MESSAGES.....	27
25. TROUBLESHOOTING	31
26. ELECTRICAL REQUIREMENTS.....	33

1. FUNDAMENTAL SAFETY WARNINGS

- The appliance is not intended for use by persons (including children) with reduced physical, sensory or mental capabilities, or lack of experience and knowledge, unless they have been given supervision or instruction concerning use of the appliance by a person responsible for their safety.
- Children should be supervised to ensure that they do not play with the appliance.
- Cleaning and user maintenance shall not be made by children without supervision.
- Never clean by immersing the appliance in water.
- This is an household appliance only. It is not intended to be used in: staff kitchen areas in shops, offices and other working environments; farm houses; by clients in hotels, motels and other residential type environments; bed and breakfast type environments.
- If the plug or power cord is damaged, it must be replaced by customer services only to avoid all risk.

FOR EUROPEAN MARKETS ONLY:

- This appliance can be used by children aged from 8 years and above if they have been given supervision or instruction concerning use of the appliance in a safe way and understand the hazards involved. User cleaning and maintenance shall not be made by children unless they are above 8 years old and supervised. Keep the appliance and power cord away from children under 8 years of age.
- The appliance can be used by persons with reduced physical, sensory or mental capabilities or lack of experience and knowledge if they are supervised or have been given instruction concerning use of the appliance in a safe way and if they understand the hazards involved.
- Children shall not play with the appliance.
- Always unplug the appliance when left unattended and before assembly, taking apart or cleaning.



Surfaces marked with this symbol become hot during use (the symbol is present in certain models only).

2. SAFETY WARNINGS

2.1 Symbols used in this Instruction for Use

Important warnings are identified by these symbols. It is vital to respect these warnings.



Danger!

Failure to observe the warning may result in life threatening injury by electric shock.



Important!

Failure to observe the warning could result in injury or damage to the appliance.



Danger of burns!

Failure to observe the warning could result in scalds or burns.



Please note:

This symbol identifies important advice or information for the user.



Danger!

This is an electrical appliance and may cause electric shock.

You should therefore follow these safety warnings:

- Never touch the appliance with damp hands or feet.
- Never touch the plug with damp hands.
- Make sure the socket used is freely accessible at all times, enabling the appliance to be unplugged when necessary.
- Unplug directly from the plug only. Never pull the cord as you could damage it.
- To disconnect the appliance completely you must unplug it from the mains socket.
- If the appliance is faulty, do not attempt to repair.
- Turn it off, unplug from the mains socket and contact Customer Services.
- Before cleaning the appliance, turn it off, unplug from the mains socket and allow to cool.



Important:

Keep all packaging (plastic bags, polystyrene foam) away from children.



Danger of burns!

This appliance produces hot water and steam may form while it is in operation.

Avoid contact with splashes of water or hot steam.

When the appliance is in operation, the cup shelf could become very hot.

2.2 Designated use

This appliance is designed and made to prepare coffee, milk and chocolate and to heat beverages.

Any other use is considered improper and thus dangerous. The manufacturer is not liable for damage deriving from improper use of the appliance.

2.3 Instruction for Use

Read this Instruction for Use carefully before using the appliance. Failure to follow this Instruction for Use may result in burns or damage to the appliance.

The manufacturer is not liable for damage deriving from failure to respect this Instruction for Use.



Please note:

Keep this Instruction for Use. If the appliance is passed to other persons, they must also be provided with this Instruction for Use.

3. INTRODUCTION

Thank you for choosing this bean to cup espresso and cappuccino machine.

Take a few minutes to read this Instruction for Use. This will avoid all risks and damage to the appliance.

3.1 Letters in brackets

The letters in brackets refer to the legend in the description of the appliance on pages 2-3.

3.2 Troubleshooting and repairs

In the event of problems, first try and resolve them by reading the information given in sections "24. Displayed messages" and "25. Troubleshooting".

If this does not resolve the problem or you require further information, you should consult Customer Services by calling the number given on the annexed "Customer Service" sheet.

If your country is not among those listed on the sheet, call the number given in the guarantee. If repairs are required, contact De'Longhi Customer Services only. The addresses are given in the guarantee certificate provided with the machine.

3.3 Download the App!



A number of functions can be controlled remotely using the De'Longhi Coffee Link App.

In the App, you can also find information, tips and curious facts about the world of coffee, together with information on your machine at your fingertips.



This symbol highlights the functions you can control or consult using the App.

You can also create up to 6 new beverages and save them in your appliance.



Please note:

Check compatible devices on "PrimaDonnaElite.delonghi.com".





4. DESCRIPTION

4.1 Description of the appliance (page 3 - A)

- A1. Beans container lid
- A2. Pre-ground coffee funnel lid
- A3. Beans container
- A4. Pre-ground coffee funnel
- A5. Grinding adjustment dial
- A6. Cup warmer shelf
- A7.  button: to turn the appliance on and off (standby)
- A8. Coffee spouts (adjustable height)
- A9. Hot water and steam connection nozzle
- A10. Coffee grounds container
- A11. Cup tray
- A12. Drip tray water level indicator
- A13. Drip tray grille
- A14. Drip tray
- A15. Water tank lid
- A16. Water tank
- A17. Water softener filter housing
- A18. Infuser door
- A19. Infuser
- A20. Power cord connector socket
- A21. Main switch (ON/OFF)

4.2 Description of the homepage (main screen)

(page 2 - B)

- B1. : menu to customise the beverages settings
- B2. : appliance settings menu
- B3. Selected aroma
- B4. Clock
- B5. Selected quantity
- B6. : aroma selection
- B7. : quantity selection
- B8. >: scroll arrow
- B9. Beverages available for selection (press the < or > scroll arrows to display all the beverages, the bottom bar indicates which screen you are viewing)
- B10. <: scroll arrow
- B11. Customisable profiles (see "17. Memorising your personal profile")

4.3 Description of the accessories

(page 2 - C)

- C1. "Total Hardness Test" indicator paper
- C2. Pre-ground coffee measure
- C3. Descaler
- C4. Water softener filter (certain models only)
- C5. Cleaning brush
- C6. Hot water/steam spout
- C7. Spout release button
- C8. Power cord
- C9. Ice cube tray (2 pieces)

4.4 Description of the milk container

(page 2 - D)

- D1. Froth adjustment and CLEAN dial
- D2. Milk container lid
- D3. Milk container
- D4. Milk intake tube
- D5. Frothed milk spout (adjustable)

4.5 "Mix carafe" description

(page 2 - E)

- E1. Lid
- E2. Funnel
- E3. Steam spout ("choco" accessory)
- E4. Choco stirrer ("choco" accessory)
- E5. "Mix carafe"
- E6. Funnel release slide
- E7. Aero stirrer ("aero" accessory)

5. BEFORE USE

5.1 Checking the appliance

After removing the packaging, make sure the product is complete and undamaged and that all accessories are present. Do not use the appliance if it is visibly damaged. Contact De'Longhi Customer Services.

5.2 Installing the appliance



Important!

When you install the appliance, you should respect the following safety warnings:

- The appliance gives off heat. After positioning the appliance on the worktop, leave a space of at least 3 cm between the surfaces of the appliance and the side and rear walls and at least 15 cm above the coffee maker.
- Water penetrating the appliance could cause damage.
- Do not place the appliance near taps or sinks.
- The appliance could be damaged if the water it contains freezes.
- Do not install the appliance in a room where the temperature could drop below freezing point.
- Arrange the power cord in such a way that it cannot be damaged by sharp edges or contact with hot surfaces (e.g. electric hot plates).

5.3 Connecting the appliance



Important!

Check that the mains power supply voltage corresponds to that indicated on the rating plate on the bottom of the appliance.

Connect the appliance to a correctly installed and efficiently earthed socket with a minimum current rating of 10A only.

If the power socket does not match the plug on the appliance, have the socket replaced with a suitable type by a qualified electrician.



5.4 Setting up the appliance



Please note!

- Coffee has been used to factory test the appliance and it is therefore completely normal for there to be traces of coffee in the mill. The machine is, however, guaranteed to be new.
 - You should customise water hardness as soon as possible following the instructions in section "20. Setting water hardness".
1. Plug the power cord (C8) connector into the socket (A20) at the back of the appliance and connect the appliance to the mains electricity supply (fig. 1). Make sure the main switch (A21) at the back of the appliance is pressed (fig. 2);

2. "SELECT LANGUAGE": press the flag corresponding to the required language;

Follow the instructions indicated on the appliance display:

3. "FILL TANK WITH FRESH WATER": remove the water tank (A16) (fig. 3), open the lid (A15) (fig. 4), fill to the MAX line with fresh water (fig. 5), close the lid and put the tank back in the appliance (fig. 6);
4. "Insert water spout": Check that the hot water/steam spout (C6) is inserted on the connection nozzle (A9) (fig. 7) and place a container holding a minimum of 100 ml underneath (fig. 8);
5. "WATER CIRCUIT EMPTY PRESS OK TO START FILLING PROCESS" appears on the display;
6. Press "OK" to confirm. The appliance delivers water from the spout (fig. 8) then goes off automatically.

The coffee machine is now ready for normal use.



Please note!

- The first time you use the coffee machine, you need to make 4-5 cups of coffee or 4-5 cappuccinos before it starts to give satisfactory results.
- When making the first 5-6 cappuccinos, it is normal to hear the noise of boiling water. After this, the noise becomes less.
- To improve the performance of your appliance, we recommend installing a water softener filter (C4) as described in section "21. Water softener filter". If your model is not provided with a filter, you can request one from De'Longhi Customer Services.

6. TURNING THE APPLIANCE ON



Please note!

Before turning the appliance on, make sure the main switch (A21) is pressed (fig. 2).

Each time the appliance is turned on, it performs an automatic preheat and rinse cycle which cannot be interrupted. The appliance is ready for use only after completion of this cycle.



Danger of burns!

During rinsing, a little hot water comes out of the coffee spouts (A8) and is collected in the drip tray (A14) underneath. Avoid contact with splashes of water.

- To turn the appliance on, press the  button (A7-fig. 9). The message "HEATING UP UNDERWAY PLEASE WAIT" appears on the display.

When heating is complete, the message changes to: "RINSING UNDERWAY, HOT WATER FROM SPOUTS". As well as heating the boiler, this also heats the internal circuits by circulating hot water.

The appliance is at temperature when the main screen (homepage) appears.

7. TURNING THE APPLIANCE OFF

Whenever the coffee machine is turned off after being used to make coffee, it performs an automatic rinse cycle.

Danger of burns!

During rinsing, a little hot water flows from the coffee spouts (A8). Avoid contact with splashes of water.

- To turn the appliance off, press the  button (A7-fig. 9).
- The message "Turning off Please wait" is displayed, then the appliance performs a rinse cycle and goes off (standby).

Please note!

If you will not be using the appliance for some time, unplug from the mains socket:

- first turn the appliance off by pressing the  button (fig. 9);
- release the main switch (A21) at the back of the appliance (fig. 2).

Important!

Never press the main switch while the appliance is on.



8. MENU SETTINGS

8.1 Rinsing

Use this function to deliver hot water from the coffee spouts (A8) and hot water/steam spout (C6), if inserted, to clean and heat the appliance's internal circuit.

Place a container with a minimum capacity of 100ml under the coffee and hot water spouts (fig. 8).

To enable the function, proceed as follows:

1. Press " (B2) to enter the menu;
2. Press < (B10) or > (B8) until " RINSING" appears on the display (B);
3. Press "" to start rinsing.

Important! Danger of burns.

Do not leave the appliance unattended while hot water is being delivered.

4. After a few seconds, hot water is delivered first from the coffee spouts, then from the hot water/steam spout (if inserted) to clean and heat the appliance's internal circuit. "RINSING UNDERWAY, HOT WATER FROM SPOUTS" appears on the display, together with a progress bar which fills gradually as preparation proceeds;
5. To stop rinsing, press " STOP" or wait for rinsing to stop automatically.

Please note!

- If the appliance is not used for more than 3-4 days, when you turn it on again, we strongly recommend performing 2/3 rinses before use;

- After cleaning, it is normal for the grounds container (A10) to contain water.

8.2 Descaling











For instructions on descaling, see section "19. Descale".

8.3 Water filter

For instructions on how to install the filter (C4), see section "21. Water softener filter".







8.4 Beverages settings

In this section, you can consult your customised settings and, if you wish, reset the default values for each beverage, except cold coffee, cold milk and chocolate.

1. Press " (B2) to enter the menu;
 2. Press < (B10) or > (B8) until " DRINKS SETTINGS" appears on the display (B);
 3. Press "". The values for the first beverage appear on the display;
 4. The reference user profile is highlighted on the display. The values are displayed on vertical bars. The default value is indicated by the  symbol, while the current value is highlighted by the solid part of the vertical bar;
 5. To go back to the settings menu, press " ESC". To scroll and display the beverages, press " NEXT";
 6. To reset the default values for the beverage displayed, press " RESET";
 7. "CONFIRM RESET?": to confirm, press " OK" (to cancel, press " ESC");
 8. "DEFAULT VALUES SET": press " OK".
- The beverage has been reset to the default values. Continue with the other beverages, or go back to the settings menu.

8.5 Set time

To adjust the time on the display (B), proceed as follows:

1. Press " (B2) to enter the menu;
2. Press < (B10) or > (B8) until " SET TIME" appears on the display (B);
3. Press "". The time setting panel appears on the display;
4. Press < or > corresponding to the hours and minutes until the current time is displayed;
5. To confirm, press " OK" (to cancel, press " ESC"), then press " ESC" to go back to the homepage.

The time is now set.









8.6 Auto-start

You can set the auto-start time in order to have the appliance ready at a certain time (for example in the morning) so you can make coffee immediately.

Please note!

To enable this function, the time must already be set correctly (see section "8.1 Set time").

To enable auto-start, proceed as follows:

1. Press " (B2) to enter the menu;
2. Press < (B10) or > (B8) until " auto-start" appears on the display (B);
3. Select the function by pressing "". The time setting panel appears on the screen;
4. Press < or > corresponding to the hours and minutes until the required auto-start time is displayed;
5. Press  or  to enable or disable auto-start.
6. To confirm, press " OK" (or cancel and go back to the settings menu by pressing " ESC"), then press " ESC" to go back to the homepage.

The auto-start time is now set and the corresponding symbol is displayed to indicate that the function has been enabled.





Please note!

When the appliance is turned off using the main switch (A21), the auto-start setting (if enabled) is lost.

8.7 Auto-off (standby)

Auto-off can be set so that the appliance goes off after 15 or 30 minutes, or 1, 2 or 3 hours.







To programme Auto-off, proceed as follows:

1. Press " (B2) to enter the menu;
2. Press < (B10) or > (B8) until " AUTO-OFF" appears on the display (B), together with the current selection (15 or 30 minutes, or 1, 2 or 3 hours);
3. Press "" to select the required value;
4. Press " ESC" to go back to the homepage.

Auto-off is now programmed.

8.8 Cup warmer







To warm the cups before making coffee, you can enable the cup warmer (A6) and rest the cups on the shelf.

1. Press " (B2) to enter the menu;
2. Press < (B10) or > (B8) until " cup warmer" appears on the display (B);
3. Press "" to enable- or disable- the cup warmer.
4. Press " ESC" to go back to the homepage.

8.9 Energy saving

Use this function to enable or disable energy saving. When enabled, the function reduces energy consumption in compliance with European regulations.





To disable or enable "Energy Saving", proceed as follows:

1. Press " (B2) to enter the menu;
2. Press < (B10) or > (B8) until " ENERGY SAVING" appears on the display (B);
3. Press "" to enable- or disable- energy saving.
4. Press " ESC" to go back to the homepage.

The corresponding symbol appears on the display alongside the time to indicate that the function has been enabled.

8.10 Coffee temperature

To modify the temperature of the water used to make the coffee, proceed as follows:

1. Press " (B2) to enter the menu;
2. Press < (B10) or > (B8) until " COFFEE TEMPERATURE" appears on the display (B) together with the current selection (LOW, MEDIUM, HIGH or MAX);
3. Press "" to select the required temperature;
4. Press " ESC" to go back to the homepage.

Please note!





A different temperature can be set for each profile (see section "17. Memorising your personal profile").

8.11 Water hardness

For instructions on setting water hardness, see section "20. Setting water hardness".



8.12 Selecting the language

To modify the language of the display (B), proceed as follows:

1. Press " (B2) to enter the menu;
2. Press < (B10) or > (B8) until " SELECT LANGUAGE" appears on the display;
3. Press "" : press < (B10) or > to display and select the flag corresponding to the required language;
4. Press " ESC" twice to go back to the homepage.

8.13 Beep

This enables or disables the beep emitted by the machine each time an icon is pressed or an accessory is inserted/removed. To disable or enable the beep, proceed as follows:

1. Press " (B2) to enter the menu;
2. Press < (B10) or > (B8) until " BEEP" appears on the display (B);

3. Press ""/> to enable- ON or disable- OFF the beep;
4. Press " ESC" to go back to the homepage.

8.14 Cup light

This function enables or disables the cup lights. The lighting is enabled by default.

The lights come on each time a coffee or milk-based beverage is made and during each rinsing cycle.

To disable or enable this function, proceed as follows:

1. Press " (B2)" to enter the menu;
2. Press < (B10) or > (B8) until " cup lighting" appears on the display (B);
3. Press " to enable- ON or disable- OFF the cup lighting;
4. Press " ESC" to go back to the homepage.

8.15 Background

You can choose the display background from the following 4 alternatives: "SHADED BLUE", "STAINLESS STEEL", "COFFEE BROWN", "DARK BLUE". Proceed as follows:

1. Press " (B2)" to enter the menu;
2. Press < (B10) or > (B8) until " BACKGROUND" appears on the display (B);
3. Press "". The available backgrounds appear on the display;
4. Select the required background by pressing the chosen panel. The appliance goes back to the settings menu with the new background;
5. Press " ESC" to go back to the homepage.

8.16 Bluetooth

This function enables or disables the protection PIN to connect to the appliance from a device.

1. Press " (B2)" to enter the menu;
2. Press < (B10) or > (B8) until " BLUETOOTH" appears on the display (B);
3. Enable or disable the PIN protection by pressing - ON) or OFF);
4. Press " ESC" to go back to the homepage.

The preset PIN is "0000". You are recommended to customise the PIN directly from the APP.

Please note!

The serial number of the appliance enables it to be identified unambiguously when an association is created with the APP.

8.17 Emptying the circuit

If the appliance is to be left idle for a period of time, or before taking it to customer services, we recommend emptying the water circuit.

Proceed as follows:

1. "EMPTY GROUNDS CONTAINER AND DRIP TRAY": extract and empty the grounds container (A10) and drip tray (A14). Press " NEXT";
2. "INSERT GROUNDS CONTAINER AND DRIP TRAY": insert the drip tray complete with grounds container;
3. "PLACE 0.5L CONTAINER UNDER SPOUTS, PRESS OK TO START": position a container under the coffee spouts (A8) and hot water spout (C6). Press " OK" (fig. 8);

Danger of burns!

Do not leave the appliance unattended while hot water is being delivered.

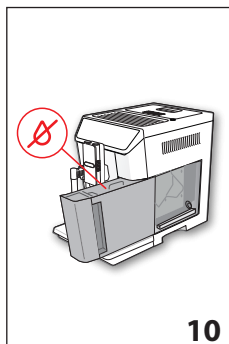

4. "RINSING UNDERWAY, PLEASE WAIT": the appliance performs a rinse cycle;
5. "EMPTY WATER TANK": extract the tank (A16) and empty it completely, then press " NEXT" (fig. 10);
6. (If the filter is installed) "REMOVE WATER SOFTENER FILTER": remove the filter from the tank. Press " NEXT";
7. "INSERT WATER TANK, PRESS OK TO CONTINUE": insert the water tank and press " OK" (fig. 6);
8. "WATER CIRC. EMPTYING UNDERWAY": wait for the appliance to empty the circuit; (Important: hot water from the spouts!);
9. "EMPTY DRIP TRAY": remove, empty and reposition the drip tray, then press " NEXT";
10. "EMPTYING COMPLETE: PRESS OK TO TURN OFF": press " OK". The appliance goes off.

Please note!

When turned on again, the appliance asks for the circuit to be filled: follow the instructions from point 3 of section "5.1 Setting up the appliance".

8.18 Default values

This resets all menu settings and programmed quantities back to the default values (with the exception of the language which remains as set).

To reset the default values, proceed as follows:

1. Press "⚙️" (B2) to enter the menu;
2. Press < (B10) or > (B8) until "📊 DEFAULT VALUES" appears on the display (B) Press "▶️";
3. Press "📊 RESET ALL" to reset all the profiles to the original parameters, otherwise select the required profile;
4. "RESET DEFAULT VALUES": press "✔️ OK" to confirm (or "⏮️ ESC" to leave the parameters unaltered);
5. "DEFAULT VALUES RESET": press "✔️ OK" to confirm and "⏮️ ESC" to go back to the homepage.

5.1 Statistics 📊

This displays statistics relating to the machine. To display the statistics, proceed as follows:

1. Press "⚙️" (B2) to enter the menu;
2. Press < (B10) or > (B8) until "📊 STATISTICS" appears on the display (B);
3. Press "📊" to verify all the available statistics by pressing < or >;
4. Press "⏮️ ESC" to go back to the homepage.

9. MAKING COFFEE

9.1 Selecting the coffee aroma

Select the required aroma from the homepage by pressing "☕ AROMA" (B6):

	(see "9.4 Making coffee using pre-ground coffee")
	X-LIGHT AROMA
	LIGHT AROMA
	MEDIUM AROMA
	STRONG AROMA
	X-STRONG AROMA
	Custom (if programmed) / Standard

9.2 Selecting the coffee quantity

Select the required quantity of coffee in the cup by pressing "☕ QUANTITY" (B7):

	SMALL SIZE
	MEDIUM SIZE
	LARGE SIZE

	EXTRA-LARGE SIZE
	Custom quantity (if programmed) / Standard quantity

9.3 Adjusting the coffee mill

The coffee mill is set by default to prepare coffee correctly and should not require regulating initially.

However, if after making the first few coffees you find that the coffee is either too weak and not creamy enough or delivery is too slow (a drop at a time), this can be corrected by adjusting the grinding adjustment dial (A5 - fig. 11).

Please note!

The grinding adjustment dial must only be turned when the coffee mill is in operation.



If the coffee is delivered too slowly or not at all, turn one click clockwise towards 7. For fuller bodied creamier coffee, turn one click anticlockwise towards 1 (do not turn more than one click at a time otherwise the coffee could be delivered a drop at a time).

These adjustments will only be evident after at least 2 cups of coffee have been delivered. If this adjustment does not obtain the desired result, turn the dial another click.

9.4 Tips for a hotter coffee

For hotter coffee, you should:

- perform a rinse cycle by selecting the "Rinsing" function in the settings menu (section "8.1 Rinsing");
- warm the cups with hot water using the hot water function (see section "12. Delivering hot water");
- increase the coffee temperature in the settings menu (see section "4.1 Coffee temperature").

9.5 Making coffee using coffee beans

Important!

Do not use caramelised or candied coffee beans as they could stick to the coffee mill and make it unusable.

1. Fill the container (A3) (fig. 12) with coffee beans;
2. Place a cup under the coffee spouts (A8);
3. Lower the spouts as near as possible to the cup (fig. 13). This makes a creamier coffee;
4. Press <(B10) or >(B8) until the required coffee is displayed;
5. Then select your required coffee from the homepage:

- ESPRESSO
 - DOPPIO+
 - COFFEE
- LONG
 - AMERICANO
 - 2X ESPRESSO
6. Preparation begins. An image of the selected beverage appears on the display (B), together with a progress bar which gradually fills as preparation proceeds.

i Please note:

- You can prepare 2 cups of ESPRESSO coffee at the same time by pressing "2X ☕" during preparation of 1 ESPRESSO (the image is displayed for a few seconds at the start of preparation).
- While the machine is making coffee, delivery can be interrupted at any moment by pressing "⊗ STOP".
- As soon as delivery has ended, to increase the quantity of coffee in the cup, just press "⊕ EXTRA". When the required quantity is reached, press "⊗ STOP".

Once the coffee has been made, the appliance is ready to make the next beverage.

i Please note!

- Various alarm messages could be displayed while using the appliance (FILL TANK, EMPTY GROUNDS CONTAINER, ETC.). Their meaning is explained in section "24. Displayed messages".
- For hotter coffee, see section "9.2 Tips for a hotter coffee".
- If the coffee is delivered a drop at a time, too weak and not creamy enough or too cold, read the tips in sections "9.1 Adjusting the coffee mill" and "25. Troubleshooting".
- Preparation of each coffee can be customised (see sections "16. Customising the beverages" and "17. Memorising your personal profile").

9.6 Making coffee using pre-ground coffee

! Important!

- Never add pre-ground coffee when the machine is off or it could spread through the inside of the machine and dirty it. This could damage the appliance.
- Never use more than 1 level measure (C2) or it could dirty the inside of the coffee machine or block the funnel (A4).

i Please note!

If you use pre-ground coffee, you can only make one cup of coffee at a time.

1. Press "☕ AROMA" (B6) repeatedly until "☕" (pre-ground) appears on the display (B).
2. Open the pre-ground coffee funnel lid (A2).
3. Make sure the funnel (A4) is not blocked, then add one level measure of pre-ground coffee (fig. 14).
4. Place a cup under the coffee spouts (A8) (fig. 13).
5. Then select your required coffee (ESPRESSO, COFFEE, LONG, AMERICANO);

6. Preparation begins. An image of the selected beverage appears on the display, together with a progress bar which gradually fills as preparation proceeds.

! Important! Making ☕ LONG coffee:

Halfway through preparation, the message "ADD PRE-GROUND COFFEE, MAXIMUM ONE MEASURE" IS DISPLAYED. Add one level measure of pre-ground coffee and press "☑ OK".

i Please note!

If "Energy Saving" mode is active, you may have to wait a few seconds before the first coffee is delivered.

10. MAKING CAPPUCCINOS AND MILK-BASED COFFEES

i Please note!

To avoid milk with poor froth or large bubbles, always clean the milk container lid (D2) and hot water connection nozzle (A9) as described in sections "4.1 Cleaning the milk container after use", "10.1 Cleaning the milk container" and "8.1 Cleaning the hot water/steam connection nozzle".

☕ 10.1 Filling and attaching the milk container



1. Remove the lid (D2) (fig. 15);
2. Fill the milk container (D3) with a sufficient quantity of milk, not exceeding the MAX level marked on the container (fig. 16). Each mark on the side of the container corresponds to about 100 ml of milk;

i Please note!

- For a denser more even froth, you must use skimmed or partially skimmed milk at refrigerator temperature (about 5°C).
 - If "Energy Saving" mode is enabled, you may have to wait a few seconds before the beverage is delivered.
3. Make sure the milk intake tube (D4) is correctly inserted in the bottom of the milk container lid (fig. 17);
 4. Place the lid back on the milk container;
 5. If present, extract the hot water/steam spout (C6) by pressing the release button (C7) (fig. 18);
 6. Attach the milk container (D) to the connection nozzle (A9) (fig. 19) and push as far as it will go. The machine emits a beep (if the beep function is enabled);
 7. Place a sufficiently large cup under the coffee spouts (A8) and frothed milk spout (D5). Adjust the length of the milk spout. To move it nearer the cup, simply pull it downwards (fig. 20).
 8. Follow the instructions below for each function.

10.2 Adjusting the amount of froth



Turn the froth adjustment dial (D1) to adjust the amount of froth on the milk delivered while making cappuccinos and milk-based coffees.

Dial position	Description	Recommended for...
	NO FROTH	HOT MILK (not frothed) / CAFFELATTE
	MIN. FROTH	LATTE MACCHIATO / FLAT WHITE
	MAX. FROTH	CAPPUCCINO / CAPPUCCINO+ / CAPPUCCINO MIX / ESPRESSO MACCHIATO / HOT MILK (frothed)

10.3 Making cappuccinos and milk-based coffees automatically

- Fill the milk container (D) and attach it as described above.
- Select the required beverage from the homepage:
 - CAPPUCCINO
 - LATTE MACCHIATO
 - CAFFELATTE
 - HOT MILK
 - CAPPUCCINO+
 - ESPRESSO MACCHIATO
 - FLAT WHITE
 - CAPPUCCINO MIX
- A message on the display (B) instructs you to turn the froth adjustment dial (D1) according to the froth required by the original recipe. Turn the dial on the milk container lid (D2) and confirm the selection by pressing " OK".
- After a few seconds, preparation begins automatically and an image of the selected beverage appears on the display, together with a progress bar which gradually fills as preparation progresses.

Please note: general indications when preparing all cappuccinos and milk-based coffees

- " ESC": press to interrupt preparation completely and go back to the homepage.
- " STOP": press to interrupt milk or coffee delivery and move on to the next delivery to complete the beverage.
- At the end of delivery, to increase the quantity of coffee in the cup, press " EXTRA".
- Preparation of each coffee can be customised (see sections "16. Customising the beverages" and "17. Memorising your personal profile").
- Do not leave the milk container out of the refrigerator for long periods. The warmer the milk (5°C is ideal), the poorer the quality of froth produced.

Once the coffee has been made, the appliance is ready to make the next beverage.

10.4 Cleaning the milk container after use



Important! Danger of burns

When cleaning the internal tubes of the milk container, a little hot water and steam leak out of the frothed milk spout (D5). Avoid contact with splashes of water.

Each time you use a milk function, "TURN DIAL TO <CLEAN> POSITION TO START CLEANING" appears on the display and the milk frother lid must be cleaned:

- Leave the milk container (D) in the machine (you do not need to empty it);
- Place a cup or other recipient under the frothed milk spout (fig. 20);
- Turn the froth adjustment dial (D1) to "CLEAN" (fig. 21). "CLEANING MILK CONTAINER UNDERWAY PLACE A RECIPIENT UNDER MILK SPOUT" appears on the display (B) (fig. 22) together with a bar which gradually fills as cleaning proceeds. Cleaning stops automatically;
- Turn the dial back to one of the froth selections;
- Remove the milk container and always clean the steam connection nozzle (A9) with a sponge (fig. 23).



Please note!

- To prepare a number of cappuccinos and milk based coffees, clean the milk container after you have prepared the last beverage only. To proceed with making the next beverages, press " ESC".
- If you do not clean the milk container, the  symbol appears on the display to remind you that it needs cleaning.
- The milk container can be kept in the refrigerator.
- In some cases, to clean you must wait for the appliance to heat up.

11. TEA FUNCTION

Important! Danger of burns.

Do not leave the appliance unattended while hot water is being delivered.

- Make sure the hot water/steam spout (C6) is attached correctly to the hot water/steam connection nozzle (A9);
- Put a tea bag in the cup, then place the cup under the spout (as close as possible to avoid splashes);
- Select " TEA FUNCTION" from the homepage;
- "HOT WATER FOR"; select:
 - the required quantity of water by pressing   (fig. 24);
 - the required water temperature by pressing one of the proposed teas (each tea, white, green, oolong or black, corresponds to a specific water temperature) (fig. 25);
- The corresponding image appears on the display (B), together with a progress bar which fills gradually as preparation proceeds;

- The machine delivers the chosen quantity of hot water, then delivery stops automatically. To stop delivery manually, press "⊗ STOP".

Preparation stops automatically.

i Please note!

- If "Energy Saving" mode is active, you may have to wait a few seconds before the hot water is delivered.
- The quantity of water in the cup can be customised (see sections "16. Customising the beverages" and "17. Memorising your personal profile").
- Delivery can be stopped at any moment by pressing "⊗ STOP";
- As soon as delivery has ended, to increase the quantity of water in the cup, just press "⊕ EXTRA". When the required quantity is reached, press "⊗ STOP".

12. DELIVERING HOT WATER

Important! Danger of burns.

Do not leave the appliance unattended while hot water is being delivered.

- Make sure the hot water/steam spout (C6) is attached correctly to the hot water/steam connection nozzle (A9);
- Place a container under the spout (as close as possible to avoid splashes);
- "  HOT WATER". The corresponding image appears on the display (B), together with a progress bar which fills gradually as preparation proceeds;
- The machine delivers about 250 ml of hot water, then delivery stops automatically. To interrupt hot water delivery manually, press "⊗ STOP".

i Please note!

- If "Energy Saving" mode is active, you may have to wait a few seconds before the hot water is delivered.
- Preparation of hot water can be customised (see sections "16. Customising the beverages" and "17. Memorising your personal profile").

13. STEAM DELIVERY

Important! Danger of burns.

Do not leave the appliance unattended while steam is being delivered.

- Make sure the hot water/steam spout (C6) is attached correctly to the hot water/steam connection nozzle (A9);
- Fill a container with the liquid to be heated or frothed and immerse the hot water/steam spout in the liquid;



- Press "  STEAM". The corresponding image appears on the display (B), together with a progress bar which fills gradually as preparation proceeds and after a few seconds, steam to heat the liquid is delivered from the hot water/steam spout;
- When the required temperature or level of froth is reached, interrupt steam delivery by pressing "⊗ STOP";

Important!

Always stop steam delivery before extracting the container containing the liquid to avoid burns from splashes.

i Please note!

If "Energy saving" is active, you may have to wait a few seconds before steam is delivered.

13.1 Tips for using steam to froth milk

- When choosing the size of the container, bear in mind that the liquid doubles or triples in volume.
- For a richer denser froth, use skimmed or partially skimmed milk at refrigerator temperature (about 5°C).
- For a creamier froth, rotate the container with slow movements in an upward direction.
- To avoid milk with poor froth or large bubbles, always clean the spout (C6) as described in the following section.

13.2 Clean the hot water/steam spout after use

Always clean the hot water/steam spout (C6) after use to avoid the build-up of milk residues and prevent it from clogging.

- Place a container under the hot water/steam spout and deliver a little water (see section "12. Delivering hot water"). Stop delivery of hot water by pressing "⊗ STOP".
- Wait a few minutes for the hot water/steam spout to cool down, then extract (fig. 18) by pressing the release button (C7). Hold the spout with one hand and with the other, turn the cappuccino maker and pull it downwards (fig. 26).
- Also remove the steam connection nozzle by pulling it downwards (fig. 27).
- Check the hole in the connection nozzle is not blocked. If necessary, clean using a toothpick.
- Wash all parts of the spout thoroughly with a sponge and warm water.
- Insert the connection nozzle, then the cappuccino maker on the nozzle by pushing it upwards and turning it clockwise until it is attached.



14. MAKING HOT CHOCOLATE

Select CHOCOLATE from the homepage and proceed as follows:

- "SELECT CUPS NUMBER AND DENSITY (STEP 1 OF 5)": press the selection arrows to choose whether to prepare 1 cup () or 2 cups () and the required density (min=; max =) , then press "> NEXT" to confirm the selection and move on to the next step;
- "ADD CHOCO STIRRER IN CARAFE (STEP 2 OF 5)": lift the carafe lid (E1) (fig. 28), pull the release slide (E7) and extract the carafe funnel (E2) (fig. 28). Make sure the steam spout (E3) and stirrer (E4) are in place (fig. 29), then insert the assembled funnel (fig. 30);
- Press "> NEXT" to move on to the next step;
- "POUR MILK OR WATER TO DESIRED LEVEL (STEP 3 OF 5)" (fig. 31): to make one cup of chocolate, pour milk at refrigerator temperature (or cold water) into the funnel up to the level. To make two cups or one mug of chocolate, pour the milk (or water) into the funnel up to the level. When you have added the milk (or water), press "> NEXT";
- "ADD CHOCOLATE POWDER THROUGH THE FUNNEL (STEP 4 OF 5)" (fig. 32): to make one cup of chocolate, add two measures (C2) (25 g) of hot chocolate powder. To make two cups or one mug of hot chocolate, add four measures of hot chocolate powder. When you have added the hot chocolate powder, press "> NEXT";



Important!

Make sure the hole in the funnel shown in fig. 33 is clean.



Please note!

- The milk must be poured into the funnel when the steam spout and stirrer are already in place. Do not exceed the level marked on the carafe. Increase or reduce the quantity of hot chocolate powder according to taste.
- To use water instead of milk, follow the instructions for milk.
- To prepare hot chocolate correctly, first pour the milk into the funnel, then add the hot chocolate or cocoa powder as shown on the chocolate carafe lid.

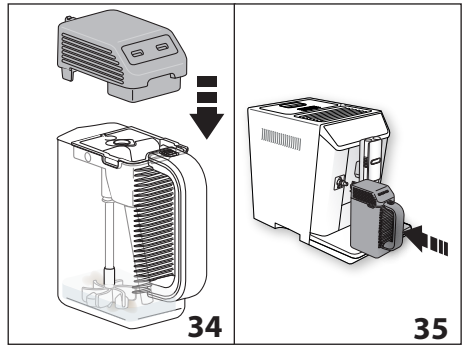

- "CLOSE LID AND INSERT CARAFE, PRESS OK TO START": Close the lid (fig. 34) and attach the carafe to the connection nozzle, pushing it as far as it will go (fig. 35). The machine emits a beep (if the beep function is enabled). press "✓ OK" to start the function;



Please note!

- If the hot chocolate powder used does not contain thickener, adjusting the density will have no effect.
 - To stop making chocolate, press "✗ STOP".
- At the end of preparation, the appliance prepares to make the next beverage. The chocolate is ready to be poured into the cup.



Danger of burns!

- While making the chocolate, the carafe and lid become very hot. Hold by the handle only to remove the carafe and pour the chocolate.
- While making the hot chocolate, it is normal for steam to come out of the holes in the chocolate carafe lid.
- Heating the milk causes splashes inside the carafe. This is normal.
- The quantity of hot chocolate in the cup varies according to the density selected. The quantity is less with a high density than with a low density.



15. MAKING COLD BEVERAGES

6.1 making cold coffee

From the homepage, select " COLD COFFEE" and proceed as follows:

- "CHOOSE AROMA (STEP 1 OF 7)" (fig. 36): select the required coffee aroma (for best results, we recommend selecting "X-STRONG AROMA"), then press "> NEXT";

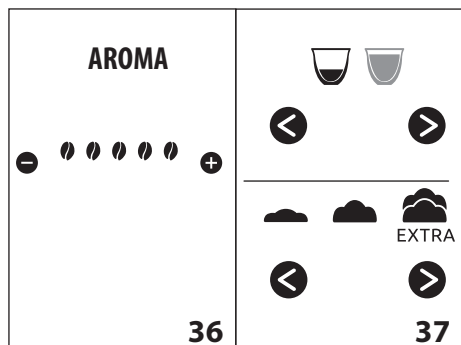

- "SELECT CUP SIZE AND FROTH QUANTITY (STEP 2 OF 7)" (fig. 37): select the quantity in the cup ("small" or "large") and one of the froth levels (☞ min, ☞ med, ☞ extra); then press "☞ NEXT";
- "ADD AERO STIRRER IN CARAFE (STEP 3 OF 7)" (fig. 38): lift the carafe lid (E1) (fig. 38), pull the release slide (E6) and extract the carafe funnel (E2) (fig. 38), then make sure the aero stirrer (E7) is inserted and attach the assembled funnel to the carafe (fig. 39);
- Press "☞ NEXT" to move on to the next step;

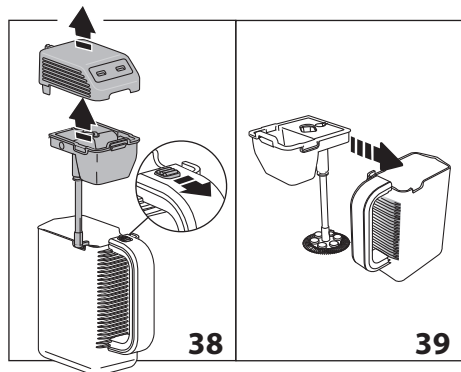

- "ADD 9 (or 18) ICE CUBES AND SUGAR (STEP 4 OF 7)" (fig. 40): add the ice cubes prepared with the mould (C9) provided and the right amount of sugar for the "small" or "large" quantity, then press "☞ NEXT";

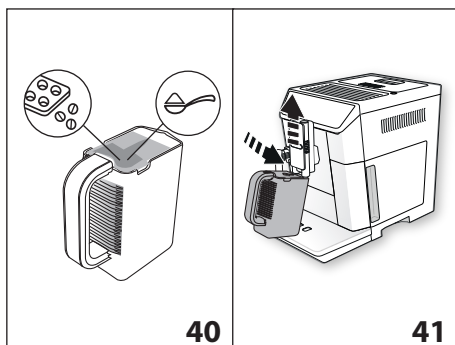

- "INSERT CARAFE UNDER COFFEE SPOUT (STEP 5 OF 7)" (fig. 41): lift the coffee spouts (A8) and position the carafe so that the coffee is delivered directly into the carafe (E): press "☑ OK" to start the function;
- Coffee is delivered into the carafe (fig. 42). "ESPRESSO DELIVERY, X-STRONG AROMA" appears on the display with a bar which gradually fills as preparation proceeds. Delivery stops automatically;

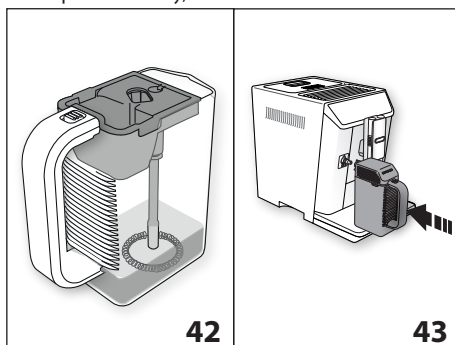

- "CLOSE LID AND INSERT CARAFE, PRESS OK TO START" (fig. 43). Extract the carafe (E), close the lid (E1) and attach the carafe to the connection nozzle, pushing as far as it will go (A9). Press "☑ OK" to start the function. The appliance starts mixing the coffee and ice and "COLD COFFEE" appears on the display (B) with a bar which gradually fills as preparation proceeds.

Preparation stops automatically.

i Please note!





To interrupt mixing manually at any moment, press "☒ STOP" and confirm with "YES". "WANT TO CONTINUE MIXING?" appears on the display: press "YES" until you obtain a satisfactory froth and/or until all the ice has melted, then press "☒ STOP". You can mix twice for a maximum of about a minute.

RECIPE FOR BEST RESULTS:



- **ICE:** add 9 ice cubes (45 g) for one cup or 18 cubes (90 g) for 2 cups. We recommend using the tray (C9) provided, designed to obtain ideal sized cubes;
- **COFFEE:** for a good cream/froth, use coffee with a high percentage of "robusta".
- **SUGAR:** use one teaspoon of sugar for each cup. We recommend using castor sugar

8.1 Making cold milk froth

From the homepage, select  "COLD MILK FOAM" and proceed as follows:

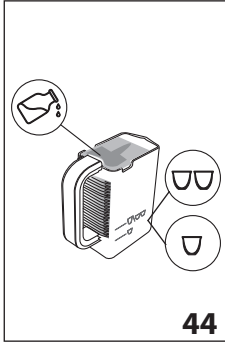

1. "SELECT CUP SIZE AND FROTH QUANTITY (STEP 1 OF 4)" (fig. 37): select the quantity in the cup ("small" or "large") and one of the froth levels (, ,  extra); then press " NEXT";
2. "ADD AERO STIRRER IN CARAFE (STEP 2 OF 7)" (fig. 39): lift the carafe lid (E1) (fig. 38), pull the release slide (E6) and extract the carafe funnel (E2) (fig. 38), then make sure the aero stirrer (E7) is inserted and attach the assembled funnel to the carafe (fig. 39);
3. Press " NEXT" to move on to the next step;



4. "POUR COLD MILK TO DESIRED LEVEL (STEP 3 OF 4)": (fig. 44): add the right amount of cold milk for the quantity selected (100 ml small cup; 200 ml large cup), then press " NEXT";
5. "CLOSE LID AND INSERT CARAFE; PRESS OK TO START";
close the lid (E1) and attach the carafe to the connection nozzle, pushing as far as it will go (A9);
6. Press " OK": stirring begins and "COLD MILK FOAM" appears on the display (B) with a bar which gradually fills as preparation proceeds;







Preparation stops automatically.

Please note!

- To interrupt mixing manually at any moment, press " STOP" and confirm with "YES";
- At the end of preparation, "WANT TO CONTINUE MIXING?" is displayed. Press "YES" until you obtain a satisfactory froth, then press " STOP". You can mix twice for a maximum of about a minute. On the other hand, if the froth is satisfactory at the end of preparation, press "NO".

16. CUSTOMISING THE BEVERAGES

The aroma (when required) and quantity of the beverages (apart from cold coffee and cold milk) can be customised.

1. Make sure the profile for which you want to customise the beverage is active;
2. From the homepage, press " (B1);
3. To access the customising screen, choose the beverage you want to customise;
4. "CHOOSE COFFEE AROMA LEVEL": Select the required aroma by pressing " or  and press " OK";
5. "CUSTOMISING COFFEE (OR WATER) QUANTITY, STOP TO SAVE": Preparation begins and the appliance displays the quantity customising screen in the form of a vertical bar. The star alongside the bar represents the current quantity.
6. When the amount reaches the minimum quantity you can set, " STOP" is displayed.
7. When the required quantity in the cup is reached, press " STOP".
8. "SAVE NEW SETTINGS?": Press "YES" or "NO".

The appliance confirms if the values have been saved or not (depending on the previous selection). Press " OK". The appliance goes back to the homepage.

Please note!

- Cappuccino and milk-based coffees: the coffee aroma is saved first, followed by the quantity of first milk, then coffee;
- Hot water: the appliance delivers hot water. Press " STOP" to save the required quantity.
- You can also customise the beverages by connecting with the DeLonghi Coffee Link App

17. MEMORISING YOUR PERSONAL PROFILE

The appliance allows you to memorise 6 different profiles, each associated with a different icon.

The profile displays the beverages most frequently selected from that profile and the aroma and quantity selections for each beverage are memorised.

To select your profile, from the homepage, press " USER 1" (B11): then select another numbered profile.

To enter another profile, press the profile currently in use then press another profile.

Please note!

- " GUEST" profile: select this profile to deliver beverages with the default settings. The  function is not active.
- You can rename your personal profile by connecting with the DeLonghi Coffee Link App.

18. CLEANING

8.1 Cleaning the machine

The following parts of the machine must be cleaned regularly:

- the appliance's internal circuit;
- coffee grounds container (A10);
- drip tray (A14);
- water tank (A16);
- coffee spouts (A8);
- pre-ground coffee funnel (A4);
- infuser (A19), accessible after opening the infuser door (A18);
- milk container (D);
- "Mix carafe" (E);
- hot water/steam connection nozzle (A9);
- touch screen (B).

Important!

- Do not use solvents, abrasive detergents or alcohol to clean the coffee machine. With De'Longhi superautomatic coffee machines, you need not use chemical products to clean the machine.
- None of the components of the appliance can be washed in a dishwasher with the exception of the milk container (D) and "Mix carafe".
- Do not use metal objects to remove encrustations or coffee deposits as they could scratch metal or plastic surfaces.

8.2 Cleaning the machine's internal circuit

If the appliance is not used for more than 3/4 days, before using it again, we strongly recommend switching it on and:

1. performing 2-3 rinse cycles by selecting the "Rinse" function (section "8.1 Rinsing");
2. delivering hot water for a few seconds (section "12. Delivering hot water").

Please note!

After cleaning, it is normal for the grounds container (A10) to contain water.

2.1 Cleaning the coffee grounds container

When "empty grounds container" appears on the display (B), the grounds container must be emptied and cleaned. The appliance cannot be used to make coffee until you have cleaned the grounds container (A10). Even if not full, the empty grounds container message is displayed 72 hours after the first coffee has been prepared. For the 72 hours to be calculated correctly, the machine must never be turned off with the main switch.

Important! Danger of burns

If you make a number of cappuccinos one after the other, the metal cup tray (A11) becomes hot. Wait for it to cool down before touching it and handle it from the front only.

To clean (with the machine on):

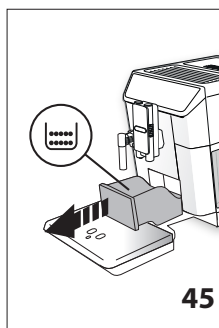

1. Remove the drip tray (A14) (fig. 45), empty and clean.
2. Empty the grounds container (A10) and clean thoroughly to remove all residues left on the bottom. This can be done using the spatula on the brush (C5) provided.
- 3.
- 4.

Important!

When removing the drip tray, the grounds container must be emptied, even if it contains few grounds. If this is not done, when you make the next coffees, the grounds container may fill up more than expected and clog the machine.

4.1 Cleaning the drip tray

Important!

The drip tray (A14) is fitted with a level indicator (A12) (red) showing the level of water it contains (fig. 46). Before the indicator protrudes from the cup tray (A11), the drip tray must be emptied and cleaned, otherwise the water may overflow the edge and damage the appliance, the surface it rests on or the surrounding area.

To remove the drip tray, proceed as follows:

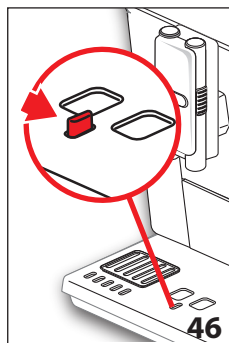

1. Remove the drip tray and the coffee grounds container (A10) (fig. 45);
2. Empty the drip tray and grounds container and wash them;
3. Put the drip tray and grounds container back in the appliance.

18.1 Cleaning the inside of the coffee machine



Before cleaning internal parts, the machine must be turned off (see section "7. Turning the appliance off") and unplugged from the mains power supply. Never immerse the coffee machine in water.

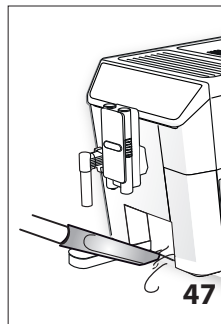

1. Check regularly (about once a month) that the inside of the appliance (accessible after removing the drip tray, A14) is not dirty. If necessary, remove coffee deposits with the brush (C5) supplied and a sponge.
2. Remove all the residues with a vacuum cleaner (fig. 47).

18.2 Cleaning the water tank

1. Clean the water tank (A16) regularly (about once a month) and whenever you replace the water softener filter (C4) (if provided) with a damp cloth and a little mild washing up liquid;
2. Remove the filter (if present) and rinse with running water;
3. Replace the filter (if provided), fill the tank with fresh water and replace the tank;
4. (Models with water softener filter only) Deliver about 100ml of hot water to reactivate the filter.

18.3 Cleaning the coffee spouts

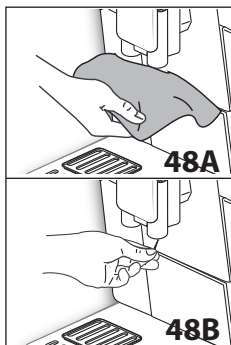

1. Clean the coffee spouts (A8) regularly with a sponge or cloth (fig. 48A);
2. Check that the holes in the coffee spouts are not blocked. If necessary, remove coffee deposits with a toothpick (fig. 48B).

18.4 Cleaning the pre-ground coffee funnel

Check regularly (about once a month) that the pre-ground coffee funnel (A4) is not blocked. If necessary, remove coffee deposits with the brush (C5) supplied.



18.5 Cleaning the infuser

The infuser (A19) must be cleaned at least once a month.



The infuser may not be extracted when the machine is on.

1. Make sure the machine is correctly turned off (see "7. Turning the appliance off");
2. Remove the water tank (A16) (fig. 3);

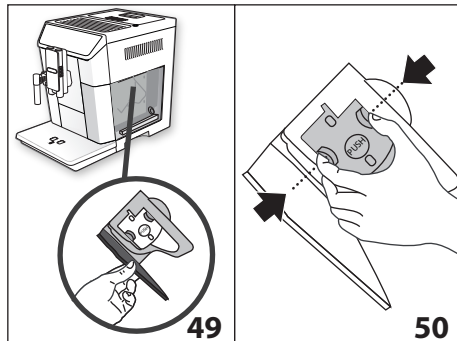

3. Open the infuser door (A18) (fig. 49) on the right side of the appliance;
4. Press the two coloured release buttons inwards and at the same time pull the infuser outwards (fig. 50);
5. Soak the infuser in water for about 5 minutes, then rinse under the tap;



RINSE WITH WATER ONLY

NO WASHING UP LIQUID - NO DISH WASHER

Clean the infuser without using washing up liquid as it could be damaged.

6. Use the brush (C5) to remove any coffee residues left in the infuser housing, visible through the infuser door;
7. After cleaning, replace the infuser by sliding it onto the internal support (fig. 51), then push the PUSH symbol fully in until it clicks into place;

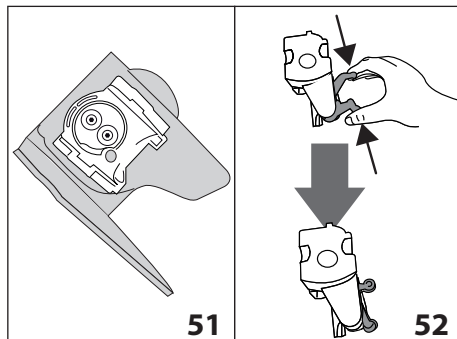



Please note!

If the infuser is difficult to insert, before insertion, adapt it to the right size by pressing the two levers shown in fig. 52.

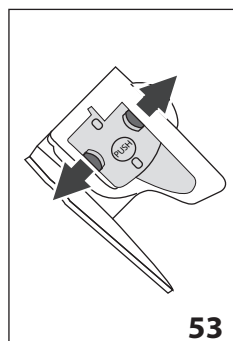

8. Once inserted, make sure the two coloured buttons have snapped out (fig. 53);
9. Close the infuser door;
10. Put the water tank back.

18.6 Cleaning the milk container

To keep the frother efficient, clean the milk container (D) every two days as described below:

1. Remove the lid (D2);
2. Remove the milk spout (D5) and intake tube (D4) (fig. 54);
3. Turn the froth adjustment dial (D1) anticlockwise to the "INSERT" position (fig. 54) and pull it off upwards;

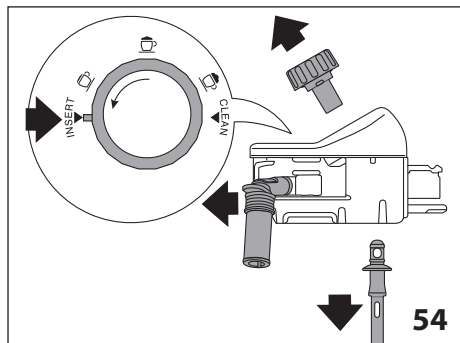

4. Wash all the components thoroughly with hot water and mild washing-up liquid. All components are dishwasher safe, placing them in the top basket of the dishwasher. Make sure there are no milk residues on the hollow and groove under the dial (fig. 55). If necessary, scrape the groove with a toothpick;

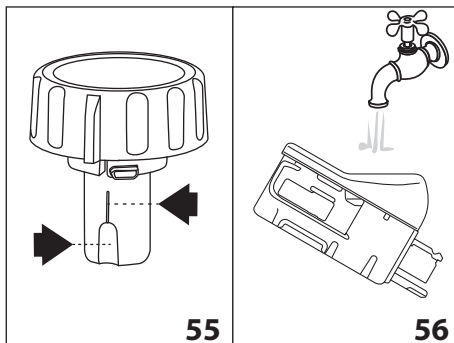

5. Rinse inside the froth adjustment dial seat with running water (fig. 56);
6. Check that the intake tube and spout are not clogged with milk residues;
7. Replace the dial (in correspondence to the word "INSERT"), spout and milk intake tube;
8. Place the lid back on the milk container (D3).

18.7 Cleaning the hot water/steam connection nozzle

Each time you prepare milk, clean the connection nozzle (A9) with a sponge to remove milk residues from the gaskets (fig. 23).

18.8 Cleaning the "Mix Carafe" (E)

After each use, clean the carafe as described below:

1. Lift the lid (E1) and remove the funnel (E2) by pressing the release button and lifting (fig. 28);
2. Extract the steam spout (D3) and "choco" or "aero" stirrer;
3. Wash all the components thoroughly with hot water and mild washing-up liquid. **All components are dishwasher safe, placing them in the top basket of the dishwasher.**
4. Replace all the components in the appliance.



Please note!

After making hot chocolate, it is normal to find residues on the stirrer while cleaning. These consist of traces of iron in the cocoa attracted by the magnets in the stirrer.







19. DESCAL







Important!

- Before use, read the instructions and the labelling on the descaler pack.
- You should use De'Longhi descaler only. Using unsuitable descaler and/or performing descaling incorrectly may result in faults not covered by the manufacturer's guarantee.

Descal the appliance when "DESCALING NEEDED PRESS OK TO START (~45min) " appears on the display (B): to descale immediately, press " OK" and follow the instructions from point 4.

To descale the appliance later, press " ESC". The  symbol appears on the display to remind you that the appliance needs descaling.

To access the descaling menu:

1. Press " (B2) to enter the menu;
2. Press < (B10) or > (B8) until " DESCALING" appears on the display;
3. Press "" to start the descaling cycle then follow the instructions on the display;
4. "REMOVE WATER SOFTENER FILTER" (fig. 57): extract the water tank (A16), remove the water softener filter (C4) (if present) and empty the water tank. Press " NEXT";

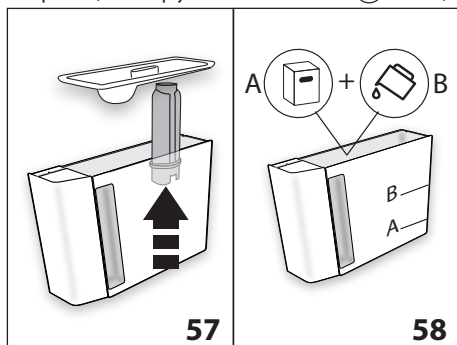

5. "ADD DE'LONGHI DESCALER (LEVEL A) AND WATER (UP TO LEVEL B)" (fig. 58): Pour the descaler into the tank up to the level A marked inside the tank (equal to one 100 ml pack), then add water (one litre) up to level B and put the water tank back. Press " NEXT";

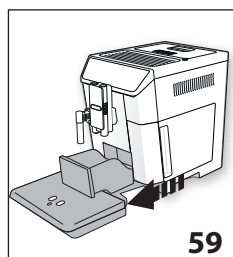



6. "EMPTY DRIP TRAY" (fig. 59): Remove, empty and replace the drip tray (A14) and grounds container (A10). Press " NEXT";
7. "PLACE 2L CONTAINER UNDER SPOUTS PRESS OK TO START DESCALING":

8. Place an empty container with a minimum capacity of 2 litres under the hot water/steam spout (C6) and coffee spouts (A8) (fig. 8);

Important! Danger of burns



Hot water containing acid flows out of the hot water/steam spout. Take care to avoid contact with splashes of this solution.

9. Press " OK" to confirm that you have added the descaling solution. "DESCALING UNDERWAY" appears on the display. The descale programme starts and the descaler liquid comes out of the hot water/steam and coffee spouts. A series of rinses and pauses is performed automatically to remove all the scale residues inside the coffee machine; After about 25 minutes, descaling stops:

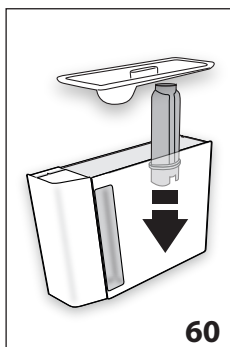
10. "RINSE AND FILL WATER TANK UP TO MAX LEVEL" (fig. 5): the appliance is now ready to rinse with fresh water. Empty the container used to collect the descaler solution. Extract the water tank, empty, rinse under running water, fill with fresh water up to the MAX level and put back in the appliance;
11. "PLACE 2L CONTAINER UNDER SPOUTS PRESS OK TO START RINSING": Place the container used to collect the descaler solution empty under the coffee spouts and hot water/steam spout (fig. 8) and press " OK";
12. Hot water is delivered first from the coffee spouts, then from the hot water/steam spout and "RINSING UNDERWAY" is displayed;
13. When the water in the tank has run out, empty the container used to collect the rinsing water;



14. "INSERT FILTER INTO ITS HOUSING" (fig. 60). Press " NEXT" and extract the water tank. Replace the water softener filter if removed previously;
15. "RINSE AND FILL WATER TANK UP TO MAX LEVEL" (fig. 5): Fill the tank up to the MAX level with fresh water;
16. "INSERT WATER TANK" (fig. 6): Put the water tank

- back in the appliance;
17. "PLACE 2L CONTAINER UNDER SPOUTS PRESS OK TO START RINSING": Place the container used to collect the descaler solution empty under the hot water/steam spout (fig. 8) and press " OK";
18. Hot water is delivered from the hot water/steam spout and "RINSING UNDERWAY" is displayed.
19. "EMPTY DRIP TRAY" (fig. 45): At the end of rinsing, remove, empty and replace the drip tray (A14) and grounds container (A10). Press " NEXT";
20. "DESCALE COMPLETE": press " OK";

- "FILL TANK WITH FRESH WATER": empty the container used to collect the rinse water, remove the water tank and fill with fresh water up to the MAX level, then put back in the appliance.

Descaling is complete.

i Please note!

- If the descaling cycle is not completed correctly (e.g. no electricity) we recommend repeating the cycle;
- After descaling, it is normal for the grounds container (A10) to contain water.
- If the water tank has not been filled to the MAX level, at the end of descaling, the appliance requests a third rinse to guarantee that the descaler solution has been completely eliminated from the machine's internal circuits.
- The appliance may request descaling cycles at very short intervals. This is normal and due to the appliance's advanced control system

20. SETTING WATER HARDNESS

The "DESCALE" message is displayed after a period of time established according to water hardness.

The machine is set by default for a hardness level of 4. The machine can also be programmed according to the hardness of the mains water in the various regions so that the machine needs to be descaled less often.

20.1 Measuring water hardness

- Remove the "TOTAL HARDNESS TEST" indicator paper (C1) from its pack (attached to the English instructions).
- Immerse the paper completely in a glass of water for one second.
- Remove the paper from the water and shake lightly. After about a minute, 1, 2, 3, or 4 red squares form, depending on the hardness of the water. Each square corresponds to one level.

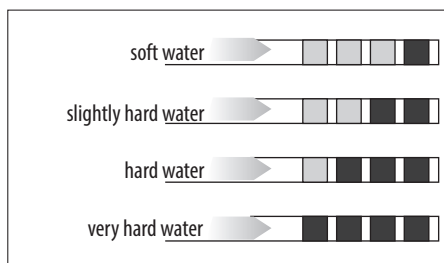

20.2 Setting water hardness

- Press "⚙️" (B2) to enter the menu;
- Press <(B10) or >(B8) until "⚙️ WATER HARDNESS" appears on the display (B);

- To change the level selected, press the symbol itself until the required level is displayed (Level 1 = soft water; Level 4 = very hard water);
- Press "⏪ ESC" to go back to the homepage.

The machine is now reprogrammed with the new water hardness setting.

21. WATER SOFTENER FILTER

Certain models are fitted with a water softener filter (C4). If this is not the case with your model, you are recommended to purchase one from De'Longhi Customer Services.

To use the filter correctly, follow the instructions below.

21.1 Installing the filter

- Remove the filter (C4) from the packaging;
- Press "⚙️" (B2) to enter the menu;
- Press <(B10) or >(B8) until "🗑️ WATER FILTER" appears on the display;
- Press "▶️";

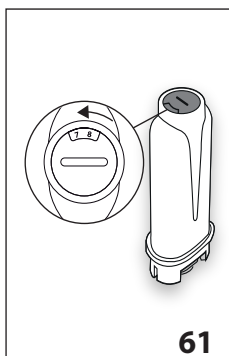

- "TURN THE DATE INDICATOR UNTIL THE NEXT 2 MONTHS ARE DISPLAYED" (fig. 61): turn the date disk to display the next two months of use. Press "▶️ NEXT";

i Please note

The filter lasts about two months if the appliance is used normally. If the coffee machine is left unused with

the filter installed, it will last a maximum of 3 weeks.

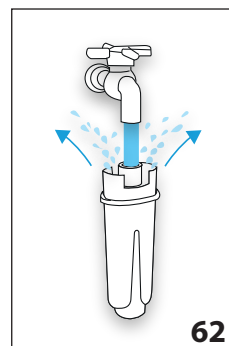

- "RUN WATER INTO FILTER HOLE UNTIL IT COMES OUT FROM OPENINGS" (fig. 62): To activate the filter, run tap water through the hole in the filter as shown in the figure until water comes out of the openings at the side for more than a minute. Press "▶️ NEXT";

- Extract the tank (A16) from the appliance and fill with water.

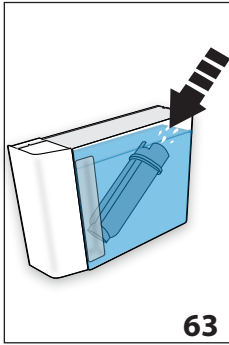

8. "IMMERSE FILTER IN THE WATER TANK LETTING AIR BUBBLES ESCAPE" (fig. 63): Insert the filter in the water tank and immerse it completely for about ten seconds, sloping it and pressing it lightly to enable the air bubbles to escape. Press "➤ NEXT";

9. "INSERT FILTER INTO ITS HOUSING AND PUSH IT DOWN TO BOTTOM": Insert the filter in the filter housing (A17) (fig. 48) and press as far as it will go. Press "➤ NEXT";
10. "INSERT WATER TANK": Close the tank with the lid (A15), then replace the tank in the machine.
11. "PLACE 0.5l CONTAINER UNDER SPOUTS, PRESS OK TO FILL FILTER" (fig. 8): Place the container under the hot water spout (C6) and press "✓ OK". Delivery begins and stops automatically.

The filter is now active and you can use the coffee machine.

21.2 Replacing the filter

Replace the filter (C4) when "⚠ REPLACE WATER SOFTENER FILTER, PRESS OK TO START" appears on the display (B1): to replace immediately, press "✓ OK" and follow the instructions from point 4.

To replace the filter later, press "⏪ ESC". The 🚰 symbol appears on the display to remind you that the filter needs replacing.

To replace, proceed as follows:

1. Extract the tank (A16) and exhausted filter;
2. Remove the new filter from the packaging;
3. Press "⚙️" (B2) to enter the menu;
4. Press <(B10) or >(B8) until "🚰 WATER FILTER" appears on the display;
5. Press "▶️";
6. "🚰 REPLACE FILTER" appears on the display;
7. Press "▶️";
8. Follow the operations described in the previous section from point 5.

The filter is now active and you can use the coffee machine.

i Please note!

After two months (see date indicator) or when the appliance has not been used for 3 weeks, you should replace the filter even if the message has not yet been displayed.

21.3 Removing the filter

Replace the filter (C4) when "REPLACE WATER SOFTENER FILTER, PRESS OK TO START ⚠" appears on the display (B). To replace the filter immediately, press "✓ OK" and follow the instructions from point 3.

To replace the filter later, press "⏪ ESC". The 🚰 symbol appears on the display to remind you that the filter needs replacing.

To use the machine without the filter, proceed as follows:

1. Extract the tank (A16) and exhausted filter;
2. Press "⚙️" (B2) to enter the menu;
3. Press <(B10) or >(B8) until "🚰 WATER FILTER" appears on the display;
4. Press "▶️";
5. "🚰 REMOVE FILTER" appears on the display;
6. Press "⏴";
7. "⚠ CONFIRM REMOVE FILTER": press "✓ OK" (or press "⏪ ESC" to go back to the settings menu);
8. "⚠ FILTER REMOVED": the change has been saved. Press "✓ OK" to go back to the homepage.

i Please note!

After two months (see date indicator) or when the appliance has not been used for 3 weeks, you should replace the filter even if the message has not yet been displayed.

22. TECHNICAL DATA

Voltage:	220-240 V~ 50/60 Hz max. 10 A
Power:	1450 W
Pressure:	1.9 MPa (19 bars)
Water tank capacity:	2 l
Size LxDxH:	260x480x375 mm
Cord length:	1750 mm
Weight:	12.4 kg
Beans container capacity:	400 g



 This appliance complies with European regulation no. 1935/2004 on food contact materials.



23. DISPOSING OF THE APPLIANCE

 The appliance must not be disposed of with household waste, but taken to an authorised waste separation and recycling centre.

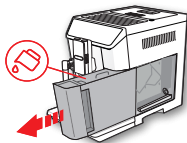
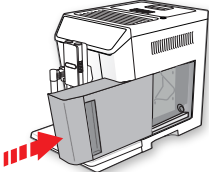
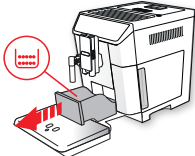
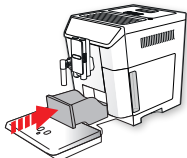
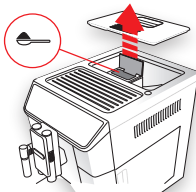



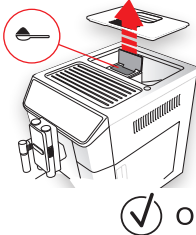
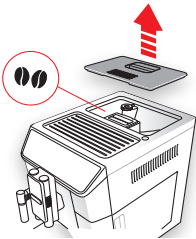
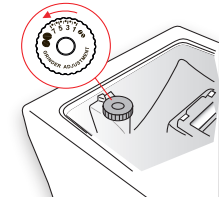



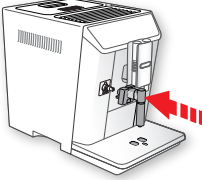
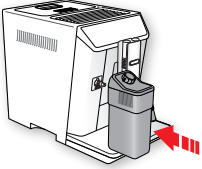
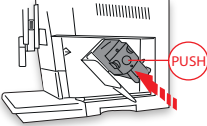
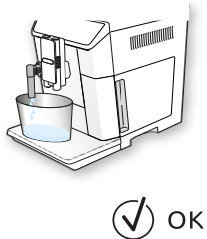
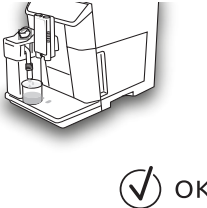



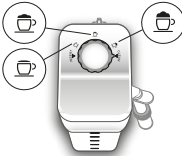









24. DISPLAYED MESSAGES

DISPLAYED MESSAGE	POSSIBLE CAUSE	REMEDY
<p>FILL TANK WITH FRESH WATER</p> 	Insufficient water in the tank (A16).	Fill the tank with water and/or insert it correctly, pushing it as far as it will go until it clicks into place.
<p>INSERT WATER TANK</p> 	The tank (A16) is not correctly in place.	Insert the tank correctly and press as far as it will go.
<p>EMPTY GROUNDS CONTAINER</p> 	The grounds container (A10) is full.	Empty the grounds container and drip tray (A14), clean and replace. Important: when removing the drip tray, the grounds container must be emptied, even if it contains few grounds. If this is not done, when you make the next coffees, the grounds container may fill up more than expected and clog the machine.
<p>INSERT GROUNDS CONTAINER</p> 	After cleaning, the grounds container (A10) has not been replaced.	Remove the drip tray (A14) and insert the grounds container.
<p>ADD PRE-GROUND COFFEE MAXIMUM ONE MEASURE</p>   ESC	The "pre-ground coffee" function has been selected without placing any pre-ground coffee in the funnel (A4).	Place pre-ground coffee in the funnel (fig. 14) and repeat delivery

<p>ADD PRE-GROUND COFFEE MAXIMUM ONE MEASURE</p>  <p>OK</p>	<p>A LONG coffee with pre-ground coffee has been requested</p>	<p>Place pre-ground coffee in the funnel (A4) (fig. 14) and press "✓ OK" to continue and complete delivery.</p>
<p>FILL BEANS CONTAINER</p>  <p>ESC</p>	<p>The coffee beans have run out. The pre-ground coffee funnel (A4) is clogged.</p>	<p>Fill the beans container(A3 - fig. 12). Empty the funnel with the help of the brush (C5) as described in section "18.2 Cleaning the pre-ground coffee funnel".</p>
<p>GROUND TOO FINE. ADJUST MILL 1 CLICK WHILE IN OPERATION</p>  <p>ESC</p>	<p>The grinding is too fine and the coffee is delivered too slowly or not at all. If the water softener filter (C4) is present, an air bubble may have been released inside the circuit, obstructing delivery.</p>	<p>Repeat coffee delivery and turn the grinding adjustment dial (A5) (fig. 11) one click clockwise towards 7 while the coffee mill is in operation. If after making at least 2 coffees delivery is still too slow, repeat the correction procedure, turning the grinding adjustment dial another click until delivery is correct (see section "9.1 Adjusting the coffee mill"). If the problem persists, make sure the water tank (A16) is fully inserted. Insert the hot water/steam spout (C6) in the appliance and deliver a little water until the flow becomes regular.</p>
<p>SELECT A Milder TASTE OR REDUCE PRE-GROUND COFFEE QUANTITY</p>  <p>ESC</p>	<p>Too much coffee has been used.</p>	<p>Select a milder taste by pressing "☉ AROMA" (B6) or reduce the quantity of pre-ground coffee (maximum 1 measure).</p>

<p>INSERT WATER SPOUT</p> 	<p>The hot water spout (C6) is not inserted or is inserted incorrectly</p>	<p>Insert the water spout as far as it will go.</p>
<p>INSERT MILK CONTAINER</p> 	<p>The milk container (D) is not inserted correctly.</p>	<p>Insert the milk container as far as it will go (fig. 19).</p>
<p>INSERT INFUSER ASSEMBLY</p> 	<p>The infuser (A19) has not been replaced after cleaning.</p>	<p>Insert the infuser as described in section "18.3 Cleaning the infuser".</p>
<p>WATER CIRCUIT EMPTY PRESS OK TO START FILLING PROCESS</p> 	<p>The water circuit is empty</p>	<p>Press "✓ OK" to deliver water from the spout (C6) until it flows out normally. Delivery stops automatically. If the problem persists, make sure the water tank (A16) is fully inserted.</p>
<p>PRESS OK TO START CLEANING PROCESS OR TURN MILK FROTH ADJUSTMENT DIAL</p> 	<p>The milk container has been inserted with the froth adjustment dial (D1) in the "CLEAN" position.</p>	<p>To proceed with the CLEAN function, press "✓ OK" or turn the froth adjustment dial to one of the milk positions.</p>

<p>TURN DIAL TO <CLEAN> POSITION TO START CLEANING</p>  <p> ESC</p>	<p>Milk has been delivered recently and the tubes inside the milk container must be cleaned (D).</p>	<p>Turn the froth adjustment dial (D1) to CLEAN (fig. 21).</p>
<p>TURN THE MILK FROTH ADJUSTMENT DIAL TO MILK POSITION</p> 	<p>The milk container has been inserted with the froth adjustment dial (D1) in the "CLEAN" position.</p>	<p>Turn the dial to the required froth position.</p>
<p>DESCALING NEEDED PRESS OK TO START (~40MIN)</p>  <p> ESC  OK</p>	<p>The machine must be descaled.</p>	<p>Press " OK" to start descaling or " ESC" to descale later. The descaling procedure described in section "19. Descale" needs to be performed.</p>
<p>REPLACE WATER SOFTENER FILTER PRESS OK TO START</p>  <p> ESC  OK</p>	<p>The water softener filter (C4) is exhausted.</p>	<p>Press " OK" to replace or remove the filter, or " ESC" to carry out the procedure later. Follow the instructions in section "21. Water softener filter".</p>
<p>GENERAL ALARM: REFER TO USER MANUAL / SMART COFFEE APP</p> 	<p>The inside of the appliance is very dirty.</p>	<p>Clean the inside of the appliance thoroughly, as described in section "18. Cleaning". If the message is still displayed after cleaning, contact customer services.</p>
	<p>The appliance needs descaling and/or the filter (C4) must be replaced.</p>	<p>The descaling procedure described in section "19. Descale" needs to be performed and/or the filter needs replacing or removing as described in section "21. Water softener filter".</p>
	<p>The tubes inside the milk container (C) must be cleaned.</p>	<p>Turn the froth adjustment dial (D1) to CLEAN (fig. 21).</p>
	<p>The filter (C4) must be replaced.</p>	<p>Replace the filter or remove it as described in section "21. Water softener filter".</p>

	The machine must be descaled.	The descaling procedure described in section "19. Descale" needs to be performed.
	The auto-start function is enabled.	To disable the function, proceed as described in section "8.2 Auto-start".
	Energy saving is enabled.	To disable energy saving, proceed as described in section "4.1 Energy saving".
	The appliance is connected to a device via bluetooth.	
CLEANING UNDERWAY PLEASE WAIT	The appliance has detected impurities in its internal circuits.	Wait for the appliance to be ready for use again and reselect the required beverage. Contact Customer Services if the problem persists.

25. TROUBLESHOOTING

Below is a list of some of the possible malfunctions.

If the problem cannot be resolved as described, contact Customer Services.

PROBLEM	POSSIBLE CAUSE	REMEDY
The coffee is not hot.	The cups were not preheated.	Warm the cups by rinsing them with hot water (Please note: you can use the hot water function).
	The infuser has cooled down because 2/3 minutes have elapsed since the last coffee was made.	Before making the coffee, heat the infuser by rinsing using the rinse function (see section "8.1 Rinsing").
	A low coffee temperature is set.	Set a hotter coffee temperature in the menu (section "4.1 Coffee temperature").
The coffee is weak or not creamy enough.	The coffee is ground too coarsely.	Turn the grinding adjustment dial (A5) one click anticlockwise towards 1 while the coffee mill is in operation (fig. 11). Continue one click at a time until coffee delivery is satisfactory. The effect is only visible after delivering 2 coffees (see section "9.1 Adjusting the coffee mill").
	The coffee is unsuitable.	Use pre-ground coffee for espresso machines.
The coffee is delivered too slowly or a drop at a time.	The coffee is ground too finely.	Turn the grinding adjustment dial (A5) one click anticlockwise towards 7 while the coffee mill is in operation (fig. 11). Continue one click at a time until coffee delivery is satisfactory. The effect is only visible after delivering 2 coffees (see section "9.1 Adjusting the coffee mill").
Coffee does not come out of one or both of the spouts.	The coffee spouts (A8) are blocked.	Clean the spouts with a toothpick (fig. 49B).

The appliance does not come on	The power cord (C8) connector is not inserted correctly.	Insert the connector as far as it will go in the socket at the back of the appliance (fig. 1).
	It is not plugged into the mains socket.	Plug into the mains socket (fig. 1).
	The main switch (A21) is not turned on.	Press the main switch (fig. 2).
The infuser cannot be extracted	The appliance has not been turned off correctly	Turn the appliance off by pressing the  button (A7) (section "7. Turning the appliance off").
At the end of descaling, the appliance requests a third rinse	During the two rinse cycles, the water tank (A16) has not been filled to the MAX level	Follow the instructions displayed by the appliance, but first empty the drip tray (A14) to avoid the water overflowing.
The milk does not come out of the milk spout (D5)	The lid (D2) of the milk container (D) is dirty	Clean the milk container lid as described in section "10.1 Cleaning the milk container".
The milk contains large bubbles and squirts out of the milk spout (D5) or there is little froth	The milk is not cold enough or is not semi-skimmed.	Use skimmed or semi-skimmed milk at refrigerator temperature (about 5° C). If the result is not as you wished, try changing brand of milk.
	The froth adjustment dial (D1) is incorrectly adjusted.	Adjust following the instructions in section "10.2 Adjusting the amount of froth".
	The milk container lid (D2) or froth adjustment dial (D1) is dirty	Clean the milk container lid and froth adjustment dial as described in section "10.1 Cleaning the milk container".
	The hot water/steam connection nozzle (A9) is dirty	Clean the connection nozzle as described in section "8.1 Cleaning the hot water/steam connection nozzle".
The cup warmer is hot, even though it has been disabled	A number of beverages have been prepared in rapid succession	
The chocolate is not sufficiently dense	The hot chocolate powder does not contain thickener.	Change the type of hot chocolate powder.
	The highest density has not been selected.	Select maximum density in the corresponding screen.
	Incorrect quantities of milk and hot chocolate powder.	Respect the instructions in section "14. making hot chocolate".
The hot chocolate is cold or there are lumps	The stirrer (E4) and steam spout (E3) are not inserted correctly in the funnel (E2).	Insert the stirrer and steam spout on the funnel.
	The instructions have not been followed.	Pour the milk/water into the funnel (E2) first, followed by the hot chocolate powder.
During cleaning, there are traces of black on the stirrer (E4)	The magnets in the stirrer attract traces of iron naturally present in the hot chocolate powder.	Clean as described in section "8.2 Cleaning the "Mix Carafe" (E)".

26. ELECTRICAL REQUIREMENTS

Before using this appliance ensure that the voltage indicated on the product corresponds with the main voltage in your home, if you are in any doubt about your supply contact your local electricity company.

The flexible mains lead is supplied connected to a B.S. 1363 fused plug having a fuse of 13 amp capacity.

Should this plug not fit the socket outlets in your home, it should be cut off and replaced with a suitable plug, following the procedure outlined below.

Note: Such a plug cannot be used for any other appliance and should therefore be properly disposed of and not left where children might find it and plug it into a supply socket - with the obvious consequent danger.

Please note: We recommend the use of good quality plugs and wall sockets that can be switched off when the machine is not in use.

IMPORTANT: The wires in the mains lead fitted to this appliance are coloured in accordance with the following code:

GREEN AND YELLOW
BLUE
BROWN

EARTH
NEUTRAL
LIVE

Green and Yellow to Earth

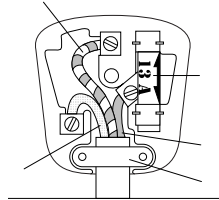

As the colours of the wires in the mains lead of this appliance may not correspond with the coloured markings identifying the terminals in your plug, proceed as follows:

- The wire which is coloured green and yellow must be connected to the terminal in the plug which is marked with the letter E or by the earth symbol  or coloured green or green and yellow.
- The wire which is coloured blue must be connected to the terminal which is marked with the letter N or coloured black.
- The wire which is coloured brown must be connected to the terminal which is marked with the letter L or coloured red.

When wiring the plug, ensure that all strands of wire are securely retained in each terminal. Do not forget to tighten the mains lead clamp on the plug. If your electricity supply point has only two pin socket outlets, or if you are in doubt, consult a qualified electrician.

Should the mains lead ever require replacement, it is essential that this operation be carried out by a qualified electrician and should only be replaced with a flexible cord of the same size.

After replacement of a fuse in the plug, the fuse cover must be refitted. If the fuse cover is lost, the plug must not be used until a replacement cover is obtained. The colour of the correct replacement fuse cover is that of the coloured insert in the base of the fuse recess or elsewhere on the plug. Always state this colour when ordering a replacement fuse cover.

Only 13amp replacement fuses which are asta approved to B.S. 1362 should be fitted.

This appliance conforms to the Norms EN 55014 regarding the suppression of radio interference.

Warning - this appliance must be earthed