

571321937/06.12

COFFEE MAKER

Instruction for use



***Please retain instructions for
future reference***

De'Longhi Appliances
Via Seitz, 47
31100 Treviso Italia

ELECTRICAL REQUIREMENTS

Before using this appliance ensure that the voltage indicated on the product corresponds with the main voltage in your home, if you are in any doubt about your supply contact your local electricity company.

The flexible mains lead is supplied connected to a B.S. 1363 fused plug having a fuse of 13 amp capacity.

Should this plug not fit the socket outlets in your home, it should be cut off and replaced with a suitable plug, following the procedure outlined below.

Note: Such a plug cannot be used for any other appliance and should therefore be properly disposed of and not left where children might find it and plug it into a supply socket - with the obvious consequent danger.

N.B. We recommend the use of good quality plugs and wall sockets that can be switched off when the machine is not in use.

IMPORTANT: the wires in the mains lead fitted to this appliance are coloured in accordance with the following code:

GREEN AND YELLOW
BLUE
BROWN

EARTH
NEUTRAL
LIVE

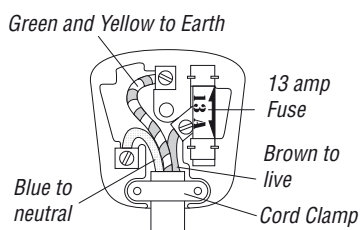

As the colours of the wires in the mains lead of this appliance may not correspond with the coloured markings identifying the terminals in your plug, proceed as follows:

- The wire which is coloured green and yellow must be connected to the terminal in the plug which is marked with the letter E or by the earth symbol \perp or coloured green or green and yellow.
- The wire which is coloured blue must be connected to the terminal which is marked with the letter N or coloured black.
- The wire which is coloured brown must be connected to the terminal which is marked with the letter L or coloured red.

When wiring the plug, ensure that all strands of wire are securely retained in each terminal. Do not forget to tighten the mains lead clamp on the plug. If your electricity supply point has only two pin socket outlets, or if you are in doubt, consult a qualified electrician.

Should the mains lead ever require replacement, it is essential that this operation be carried out by a qualified electrician and should only be replaced with a flexible cord of the same size.

After replacement of a fuse in the plug, the fuse cover must be refitted. If the fuse cover is lost, the plug must not be used until a replacement cover is obtained. The colour of the correct replacement fuse cover is that of the coloured insert in the base of the fuse recess or elsewhere on the plug. Always state this colour when ordering a replacement fuse cover.

Only 13amp replacement fuses which are asta approved to B.S. 1362 should be fitted.

This appliance conforms to the Norms EN 55014 regarding the suppression of radio interference.

Warning - this appliance must be earthed

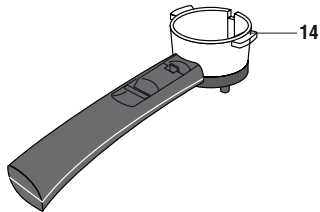
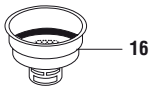
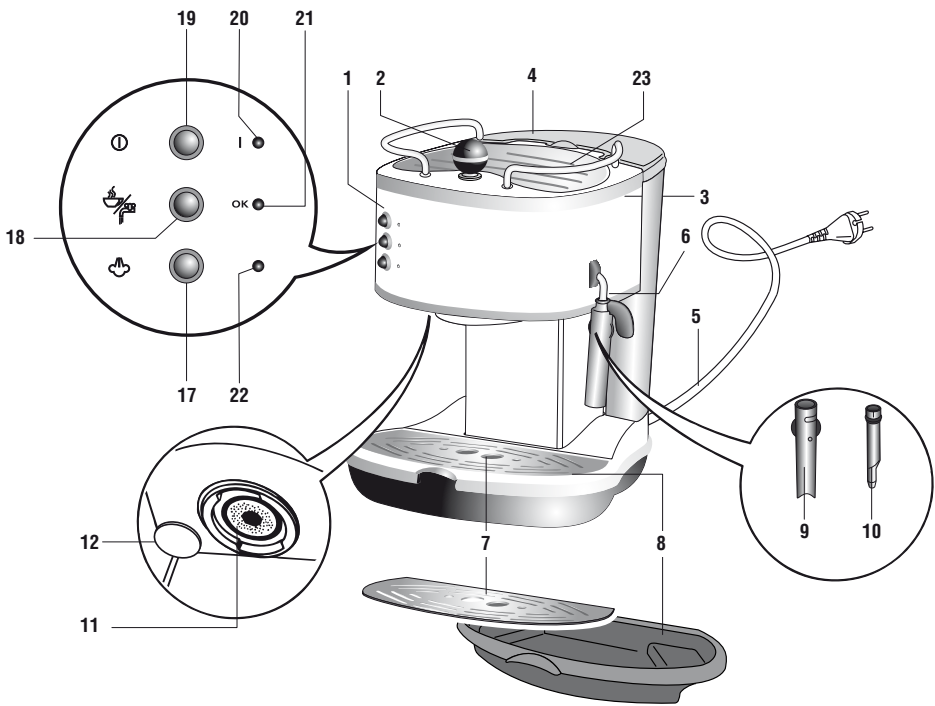

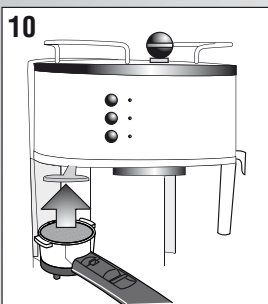
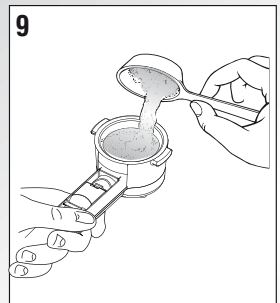
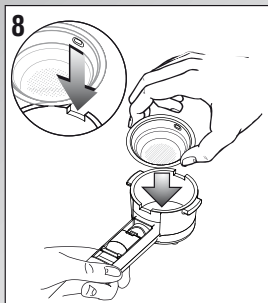
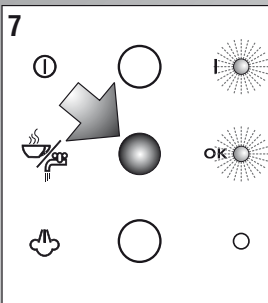
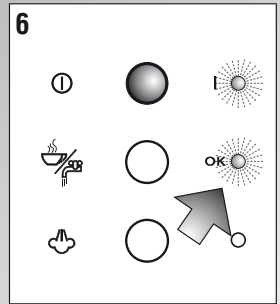
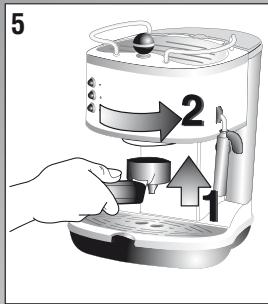
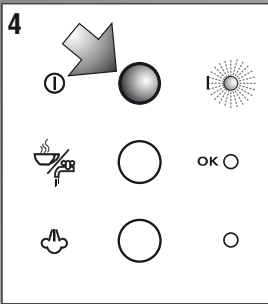
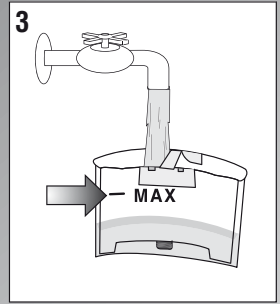
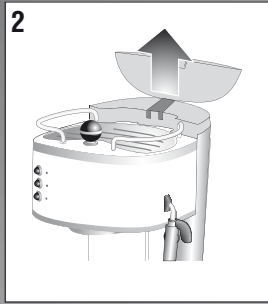
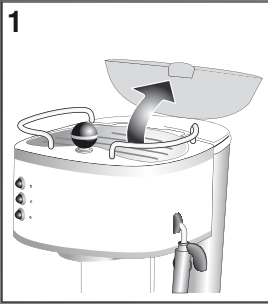

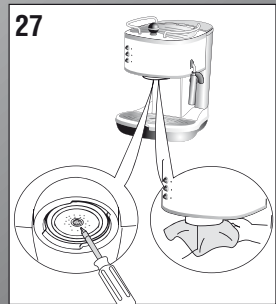
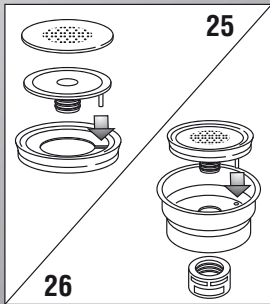
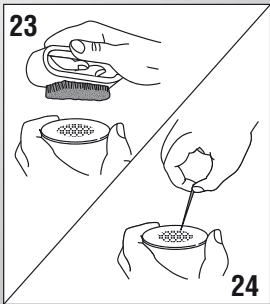
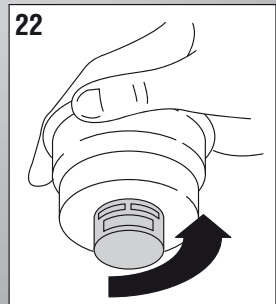
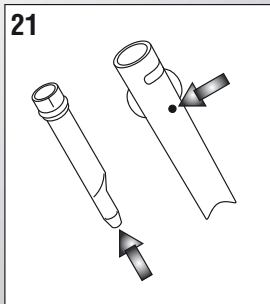
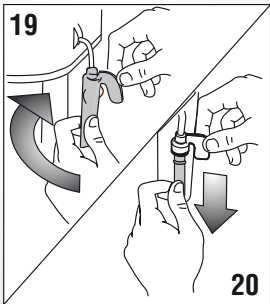
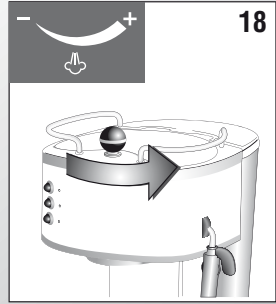
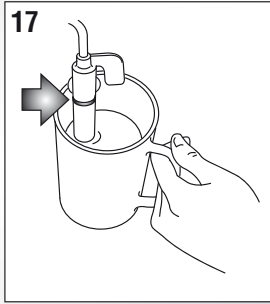
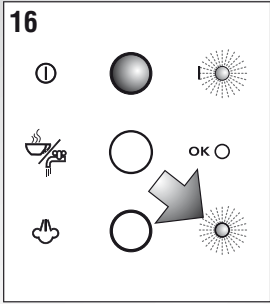
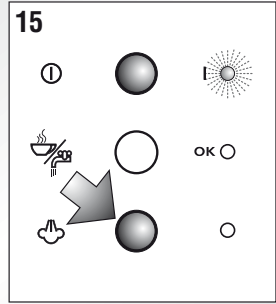
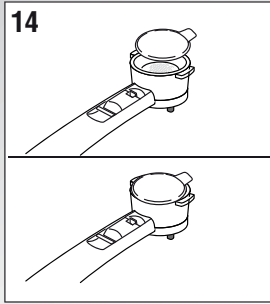
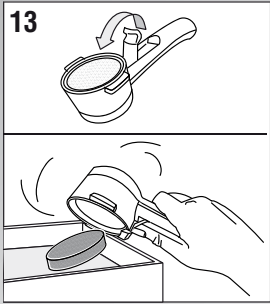



INTRODUCTION

Thank you for choosing this De'Longhi Coffee machine. We hope you enjoy your new appliance. Please take a few minutes to read these instructions. This is the only way to ensure optimum results and maximum safety.

Symbols used in these instructions

The important recommendations have these symbols. These recommendations must be followed.

 **Danger!** Failure to comply can be or is the cause of injury due to life-threatening electric shocks.

 **Attention!** Failure to comply can be or is the cause of injury or damage to the appliance.

 **Scalding hazard!** Failure to comply can be or is the cause of scalding or burns.

 **Please Note:** This symbol highlights recommendations and important information for the user.

SAFETY

Fundamental recommendations regarding safety

 **Danger!** As the appliance operates using electric current, electric shocks can not be excluded.

Therefore, follow the safety recommendations given:

- Do not touch the appliance when you have wet hands or feet.
- Do not touch the plug with wet hands.
- Make sure that the socket used can always be easily reached, so that the plug can be removed when required.
- Remove the plug from the socket by acting directly on the plug itself. Do not pull the cable as damage could be caused.
- Remove the plug from the socket to disconnect the appliance completely.
- Do not attempt to repair the appliance if it should breakdown.

Switch the appliance off, remove the plug from the socket and contact the After-Sales Service. Please refer to enclosed guarantee leaflet for details.

- If the plug or power supply cable are damaged, have them replaced exclusively by the De'Longhi After-Sales Service, in order to prevent risks. Please refer to enclosed guarantee leaflet for details.

 **Attention:** Keep the packaging material (plastic bags, expanded polystyrene) out of the reach of children.

 **Attention:** The appliance is not intended for use by persons (including children) with reduced physical, sensory or mental capabilities, or lack of experience and knowledge, unless they have been given supervision or instruction concerning use of the appliance by a person responsible for their safety. Children should be supervised to ensure that they do not play with the appliance.

 **Scalding hazard!** This appliance produces hot water and steam may form when it is operating. Pay attention not to come into contact with hot water sprays or steam. Do not touch the cup warmer plate when the appliance is on; it is hot.

CONDITIONS OF USE

This appliance is manufactured for the preparation of coffee and to heat beverages.

The appliance is designed and produced for domestic use only. It is not suitable for use in:

- staff kitchens in shops, offices and other workplaces.
- farms
- hotels, motels or other holiday accommodation
- guest houses

Any other use must be considered improper and therefore dangerous.

The manufacturer is not liable for damage deriving from the improper use of the appliance.

INSTRUCTIONS FOR USE

Read these instructions carefully before using the appliances.

- Failure to comply with these instructions can lead to injury and damage to the machine.

The manufacturer is not liable for damage deriving from the failure to comply with the user instructions.

 **Please Note:** Keep these instructions carefully. If the appliance should be transferred to other persons, these instructions must accompany it.

DESCRIPTION

1. Control panel
2. Steam knob
3. Water tank
4. Water tank lid
5. Power supply cable
6. Steam or hot water tube
7. Cup tray
8. Drip tray
9. Cappuccino maker
10. Nozzle
11. Boiler outlet

12. Coffee tamper
13. Measure for ground coffee
14. Filter-holder
15. Large filter, 2 cups
16. Small filter, 1 cup or for ESE pod
17. Steam function selection button
18. Coffee or hot water tube
19. On/off button
20. On indicator light
21. OK indicator light
22. Steam function selected indicator light
23. Cup warmer plate

PRELIMINARY OPERATIONS

Check after transport

After the packaging has been removed, check the integrity of the appliance and the presence of all accessories.

Do not use the appliance in the presence of obvious damage. Contact the De'Longhi After-Sales Service.

Installing the appliance

The following safety measures must be complied with when installing the appliance:

- The appliance could be damaged by the penetration of water.
Do not position the appliance near to water taps or sinks.
- The appliance could be damaged if the water it contains freezes. Do not install the appliance in a room where the temperature can fall below freezing point.
- Position the power supply cable in a way that it cannot be damaged by sharp edges or by contact with hot surfaces (e.g. electric plates).

Connecting the appliance



Attention! Make sure that the electric mains voltage corresponds with that indicated on the data plate on the base of the appliance.

- Only connect the appliance to a correctly installed socket with a minimum rating of 10A and correctly earthed.
- In the case of incompatibility between the socket and the plug on the appliance, have the plug replaced by a qualified technician.
- The power supply cable on this appliance must never be replaced by the user as special tools are needed for this operation. Contact an After-Sales Centre authorised by the manufacture if the cable is damaged or must be replaced, in order to avoid all risks. Please refer to enclosed guarantee leaflet for details

Filling the water tank

1. Open the water tank lid (fig. 1) and then lift the tank to remove it (fig. 2).

2. Fill the tank with fresh water but do not pass MAX. (fig. 3). Re-position the tank by pressing it lightly in a way to open the valve situated on the base of the tank itself.
3. Alternatively, do not remove the tank, just fill it by pouring in water from a jug, be careful of splashes



Attention: do not operate the appliance without water in the tank and always fill it when the water is a few centimetres from the bottom.



Please Note: it is normal to find water in the compartment under the tank; dry using a clean sponge.

USING FOR THE FIRST TIME

Pre-heating the coffee machine

Before using the machine for the first time all accessories and internal circuits must be washed by making at least five cups of coffee without using ground coffee.

It is advised to pre-heat the coffee machine as follows in order to obtain an espresso coffee at the right temperature:

1. Press the ON/OFF button (the relative indicator light switches on) (fig. 4) and attach the empty filter-holder to the machine (fig. 5).
2. Place a cup under the filter-holder. Use the same cup in which the coffee is to be served so that it can be pre-heated.
3. Wait until the OK light comes on (fig. 6) and then press the coffee button straight away (fig. 7). Allow the water to run until the OK light switches off and then stop the water by pressing the coffee button again (fig. 7).
4. Empty the cup, wait for the "OK" light to switch on again and repeat the same operation again.

(It is normal for a small, harmless puff of steam to be released when the filter-holder is removed).

MAKING AN ESPRESSO USING GROUND COFFEE

1. After having pre-heated the machine as described in the previous paragraph, in-
sert the ground coffee filter into the filter-holder, making sure that the projection is correctly inserted into the relative seat as indicated in fig. 8. Use the smallest filter for one coffee or the larger one to make two cups of coffee.
2. To prepare one coffee, fill the filter with a level measuring spoon of ground coffee, about 7gr. (fig. 9). If you wish to prepare two cups of coffee, fill the filter with two less-than-level measuring spoons of ground coffee (about 6+6 gr). Fill the filter with small amounts at a time to prevent the coffee spilling out.



Attention: for correct use, before filling the filter with ground coffee always make sure there is no residual coffee in the filter from the previous infusion.

3. Distribute the ground coffee evenly and press it lightly using the coffee tamper (fig. 10). Pressing the ground coffee is very important to obtain a good espresso. If you press too hard, the coffee will run out slowly. If you press too lightly, the coffee will run out too fast.
4. Remove any excess coffee from the rim of the filter-holder and attach it to the machine: turning it fully home to the right (fig. 5) to prevent water from escaping.
5. Position the cup or cups under the filter-holder spouts (fig. 11). It is recommended to warm the cups before making the coffee by running them under hot water or leaving them to pre-heat on the cup warmer for at least 15-20 minutes or by following the rinse method in 'using for the first time' (fig. 12).
6. Make sure that the OK light (fig. 6) is on (if it is off, wait for it to switch on) and press the coffee button (fig. 7). Once the desired amount of coffee has been obtained, press the same button again (fig. 7). (It is recommended not to run the coffee for more than 45 seconds).
7. Turn the filter holder from right to left to release the filter-holder.



Scalding hazard! To prevent sprays, do not release the filter-holder while the machine is dispensing coffee.



8. To remove the used coffee, lock the filter using the lever in the grip and let the coffee fall out by knocking the over-turned filter-holder (fig. 13).
9. Turn the machine off by pressing the on/off button (fig. 4).

MAKING AN ESPRESSO USING PODS

1. Pre-heat the machine as described in the "USING FOR THE FIRST TIME" chapter, making sure that the filter-holder is attached to the machine. Hotter coffee is obtained in this way.



Please Note: use pods that comply with the ESE Standard: this will be indicated on the packaging by the following mark.

The ESE Standard is a system accepted by the leading coffee pod manufacturers and allows espresso coffee to be made simply and without making a mess.



2. Place the small filter in the filter-holder, making sure that the projection is correctly inserted into the

relative seat as indicated in fig. 8.

3. Insert the pod, centring it as far as possible on the filter (fig. 14). Always follow the instructions of the pod pack for correct positioning of the pod on the filter.
4. Attach the filter-holder to the machine, turning it fully home to the right (fig. 5).
5. Then proceed as in points 5, 6 and 7 in the previous paragraph.

MAKING A CAPPUCCINO

1. Prepare the espresso coffee as described in the previous paragraphs, using cups that are large enough (160ml).
2. Press the steam button (fig. 15).
3. In the meantime, fill a container with about 100 grams of milk for every cappuccino to be prepared. The milk must be at refrigerator temperature (5°C). When choosing the container consider that the volume of the milk will increase by 2 or 3 times.



Please Note: it is recommended to use semi-skimmed milk at refrigerator temperature (+/- 5°C).

4. Open the steam tap for a few seconds to remove any water present in the circuit. Close the tap.
5. Position the container with the milk under the cappuccino maker nozzle.
6. Wait for the indicator light relative to the steam button to switch on (fig. 16). This indicates that the boiler has reached the ideal temperature for the production of steam.
7. Dip the cappuccino maker into the milk a few millimeters (fig. 17) making sure not to immerse the raised line on the cappuccino maker (indicated by the arrow in fig. 17). Turn the knob anti-clockwise, (fig. 18) for at least half a turn. Steam escapes from the cappuccino maker, giving the milk a creamy appearance and increasing its volume. To obtain a creamier froth, dip the cappuccino maker into the milk and turn the container with slow movements from the bottom upwards.
8. When the volume of the milk has doubled, dip the cappuccino maker deep down and continue to heat the milk. When the desired temperature (ideal value is 60°C) and the desired milk froth have been reached, interrupt the steam by turning the steam knob clockwise and release the steam button. Use the on/off button to switch the machine off (fig. 4) (The relative on light switches off).
9. Pour the frothed milk into the cups containing the previously-prepared espresso coffee. The cappuccino is ready: add sugar at will and if desired, sprinkle a little powdered chocolate on top of the froth.



Please Note:

- if more than one cappuccino is to be prepared, first make all of the coffees and then prepare the milk for all of the cappuccinos;
- if more coffee must be prepared after the milk has been frothed, allow the boiler to cool first otherwise the coffee will be burned.

To cool it, position a container under the filter-holder spouts (fig. 11), press the steam button and allow water to run out until the steam function light switches off: then prepare the coffee.

- Maximum steam delivery of 60 seconds is recommended and the milk must not be frothed more than 3 times consecutively.



Attention: the cappuccino maker must always be washed after use to ensure hygiene.

Proceed as follows:

1. Discharge a small amount of steam for a few seconds (see points 2,5 and 6 of the previous paragraph) by turning the steam knob (fig. 18). By doing this, the cappuccino maker empties any milk left inside. Switch the machine off by pressing the ON/OFF button.
2. Use one hand to hold the cappuccino tube and the other to release the cappuccino maker by turning it clockwise and pulling it downwards (fig. 19).
3. Remove the steam nozzle from the tube by pulling it downwards (fig. 20).
4. Wash the cappuccino maker and steam nozzle thoroughly in warm water.
5. Make sure that the two holes indicated by the arrows in fig. 21 are not blocked. Clean using a pin if necessary.
6. Re-mount the steam nozzle by inserting it firmly upwards into the steam tube.
7. Re-mount the cappuccino maker by inserting it upwards and turning it anti-clockwise.

PRODUCING HOT WATER

1. Switch the machine on by pressing the on/off button (fig. 4). Wait for the OK light to switch on (fig. 6).
2. Position a container under the cappuccino maker.
3. Press the coffee button (fig. 7) and turn the steam knob anti-clockwise at the same time (fig. 18): the hot water will escape from the cappuccino maker.
4. To interrupt the hot water, turn the steam knob clockwise and press the coffee button again (fig. 7).



Maximum delivery of 60 seconds is recommended.

CLEANING



Danger! Before performing any cleaning operations of the external parts of the appliance, switch the machine off, remove the plug from the socket and let the machine cool down.

Cleaning and maintenance of the filter

Clean the filter-holder and ground coffee filters about every 200 coffees and if the coffee drips through the filter-holder and does not flow completely:

- Remove the filter from the filter-holder.
- Unscrew the filter cap (fig. 22) in the direction indicated by the arrow on the cap itself.
- Slide the cream enhancer device from the container by pushing it from the cap end.
- Remove the gasket.
- Rinse all components and clean the metal filter thoroughly using hot water and a brush (fig. 23). Check that the holes in the metal filter are not blocked. If this is not the case, clean them using a pin (see fig. 24) or when descaling.
- Re-mount the filter and the gasket on the plastic disc as indicated in (fig. 25). Make sure that the plastic disc pin is inserted inside the hole in the gasket as indicated by the arrow in (fig. 25).
- Re-insert the unit obtained into the steel container for the filter (fig. 26), making sure that the pin is inserted into the hole of the support itself (see arrow fig. 26).
- Finally, tighten the tap.



The warranty is not valid if the cleaning operations described above are not performed on a regular basis.

Cleaning the boiler outlet

About every 200 coffees the espresso boiler outlet must be cleaned as follows:

- Make sure that the coffee machine is not hot and the plug is disconnected from the socket;
- Use a screwdriver to remove the screw that fixes the espresso boiler outlet (fig. 27);
- Remove the boiler outlet;
- Clean the boiler using a damp cloth (fig. 27);
- Clean the outlet thoroughly using hot water and a brush. Check that the holes are not blocked. If this is not the case, clean them using a pin (fig. 24).
- Rinse the outlet under the tap, rubbing continuously.
- Re-mount the boiler outlet, paying attention to position it correctly on the gasket.



The warranty is not valid if the cleaning operations described above are not performed on a regular basis.

Other cleaning operations

1. Do not use solvents or abrasive detergents to clean the machine. Use a soft, damp cloth.
2. Clean the filter-holder cup, the filters, drip tray and water tank regularly.
To empty the drip tray, remove the cup warmer grid, remove the water and clean the tray using a cloth: then re-assemble the drip tray.
Clean the water tank using a soft bottle-brush in order to reach the bottom.



Danger! During cleaning, never immerse the machine in water: it is an electric appliance.

DESCALING

It is recommended to descale the machine about every 200 coffees.

It is recommended to use De'Longhi descaler that can be found on the market.

Follow this procedure:

1. Fill the tank with the descaling solution obtained by diluting the descaler with water following the indications given on the pack.
2. Press the on/off button and wait for the OK light to switch on.
3. Make sure that the filter holder is not attached and position a suitable container under the machine outlet.
4. Press the coffee button and allow about 1/4 of the solution contained in the tank flow out: every now and again turn the steam knob and allow a small amount of solution to escape; then interrupt by pressing the button again and leave the solution to act for about 5 minutes.
5. Repeat point 4 another 3 times, until the tank is completely empty.
6. To eliminate residues of the descaling solution, rinse the tank well and fill it with clean water.
7. Press the coffee button (fig. 6) and operate the appliance until the tank is completely empty.
8. Repeat operations 6 and 7 again.



Repairs to the coffee machine relative to lime scale problems are not covered by the warranty if the above-described descaling is not performed on a regular basis.

DISPOSAL

Recommendations for the correct disposal of the product in compliance with the 2002/96/CE European Directive.



The product must not be disposed of as urban waste at the end of its working life.
It must be taken to appropriate local authority separate waste collection centres or to dealers

providing this service.

Disposing of a household appliance separately avoids possible negative consequences for the environment and health deriving from unsuitable disposal and allows to recover the materials of which it is made in order to make significant savings in energy and resources.

The product has the crossed-out wheeled bin mark as a reminder of the obligation to dispose of household appliances separately.

TECHNICAL DATA

Mains voltage:	220-240V~50/60Hz
Absorbed power:	1100W
Pressure:	15 bar
Water tank capacity:	1,4 litres
Dimensions LxHxD	255x315x280 (395)
mm	
Weight	3,9 kg



The appliance is in compliance with the following CE Directives:

- “Low voltage Directive” 2006/95/CE and suc-cessive amendments.
- “EMC Directive” EMC 2004/108/CE and suc-cessive amendments.
- The materials and objects destined to come into contact with food stuffs are in compliance with the provisions of the 1935/2004 European Standard.

PROBLEM	POSSIBLE CAUSES	SOLUTION
Espresso coffee does not flow out	• No water in the tank	• Fill the water tank
	• The holes in the filter-holder are blocked	• Clean the holes in the filter-holder spouts
	• The espresso boiler outlet is blocked	• Clean as indicated in the “Cleaning the boiler outlet” paragraph
Espresso coffee drips from the edges of the filter-holder instead of through the holes	• The filter-holder is inserted incorrectly	• Attach the filter-holder correctly and turn it fully home firmly to the right
	• The espresso boiler gasket has lost elasticity	• Replace the espresso boiler gasket at an After-Sales Centre
	• The holes in the filter-holder spout are blocked	• Clean the holes in the spouts.
The espresso coffee is cold	• The espresso OK light is not on when the coffee button is pressed	• Wait for the OK light to switch on
	• Pre-heating has not been carried out	• Pre-heat as indicated in the paragraph
	• The cups have not been pre-heated	• Pre-heat the cups using hot water or leaving them for at least 20 minutes on the cup warmer plate on the lid
Loud pump noise	• The water tank is empty	• Fill the water tank
	• The tank is inserted incorrectly and the valve on the bottom is not open	• Press the tank lightly to open the valve on the bottom
The coffee flows quickly from the spout	• The ground coffee has not been sufficiently pressed	• Tamp the ground coffee more (fig. 10)
	• Not enough ground coffee	• Increase the amount of ground coffee
	• The coffee is not ground finely enough	• Only use coffee ground specifically for espresso coffee machines
	• Incorrect type of ground coffee	• Change the quality of the ground coffee
	• No 'ESE' Pod	• Use 'ESE' Pod
The coffee flows slowly from the spout	• The ground coffee is too tightly pressed	• Tamp the coffee less (fig. 6)
	• Too much ground coffee	• Decrease the amount of ground coffee
	• The espresso boiler outlet is blocked	• Clean as indicated in the “Cleaning the espresso boiler outlet” chapter.
	• The filter is blocked	• Clean as indicated in the “Cleaning the filter” par.
	• The coffee is too finely ground	• Only use coffee ground specifically for espresso coffee machines
	• The ground coffee is too fine or is damp	• Only use coffee ground specifically for espresso coffee machines and it must not be damp
	• Incorrect type of ground coffee	• Change the quality of the ground coffee powder
	• No 'ESE' Pod	• Use 'ESE' Pod
The milk does not froth when making a cappuccino	• The milk is not cold enough	• Always use milk at refrigerator temperature
	• The cappuccino maker is dirty	• Carefully clean the holes in the cappuccino maker, in particular, those indicated in figure 21