

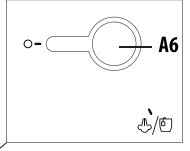

咖 啡 机
COFFEE MAKER

使
用
说
明
书

A

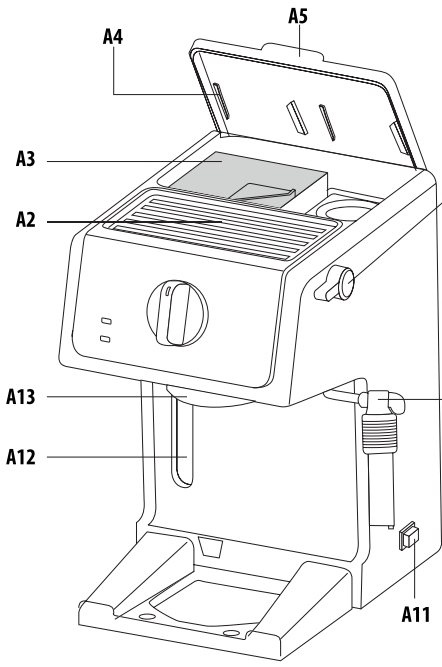
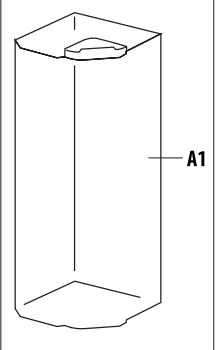

ECP3X.31

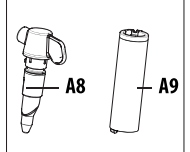
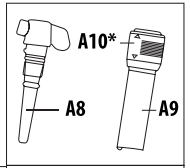

ECP3X.21

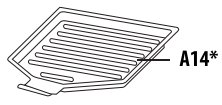

ECP3X.31

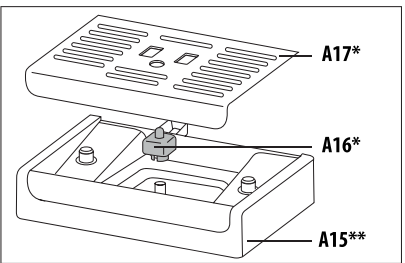

ECP3X.21

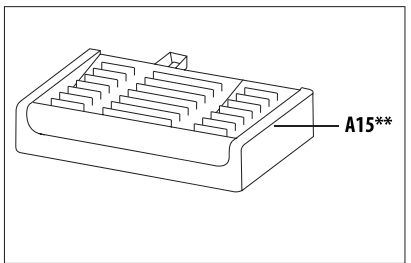

B

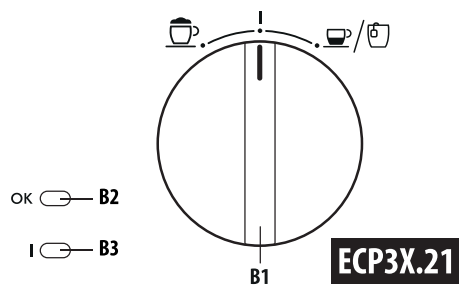
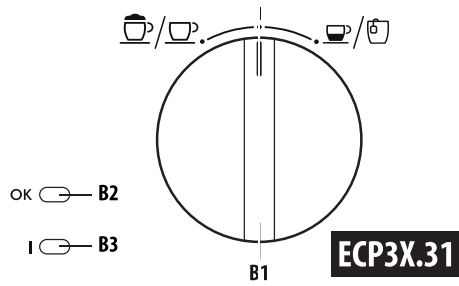

C

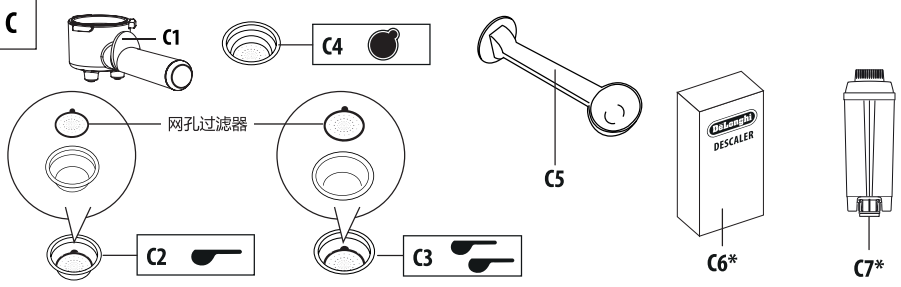

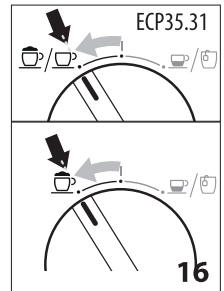
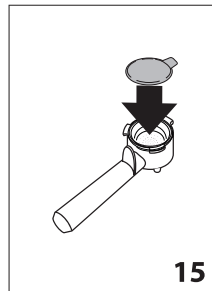
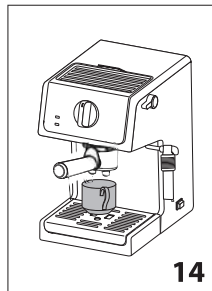
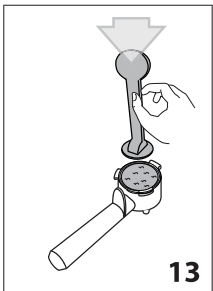
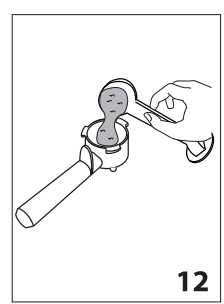
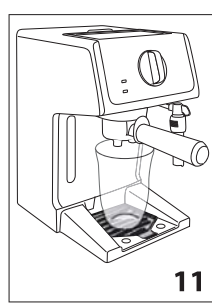
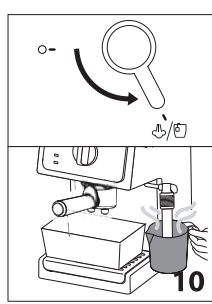
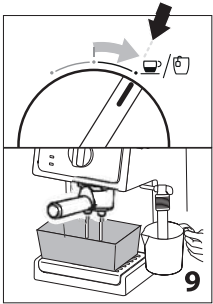
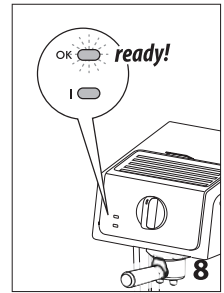
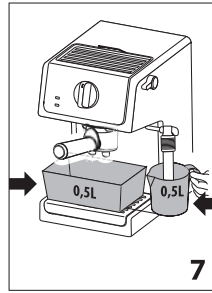
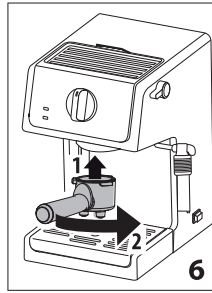
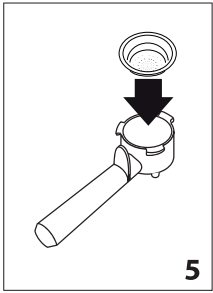
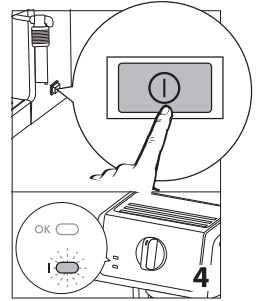
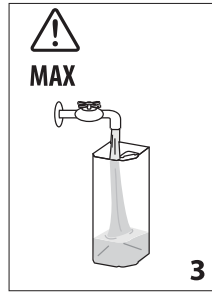
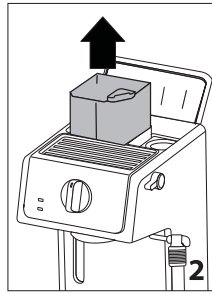
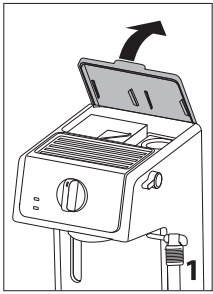

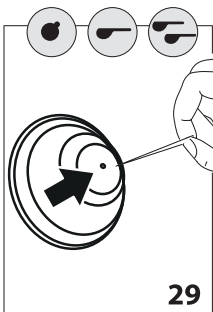
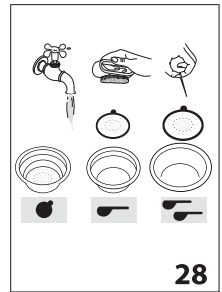
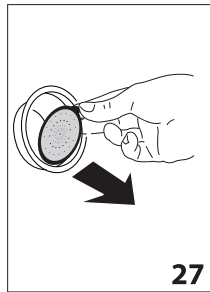
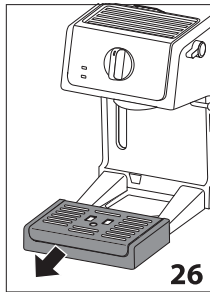
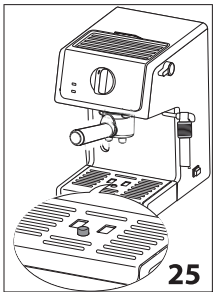
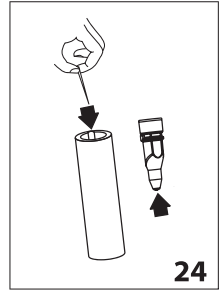
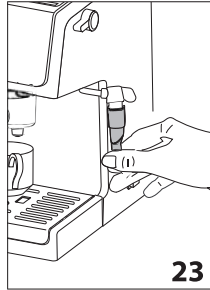
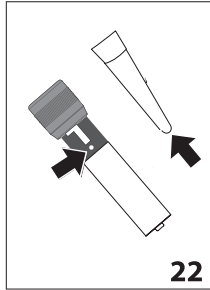
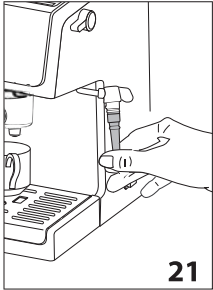
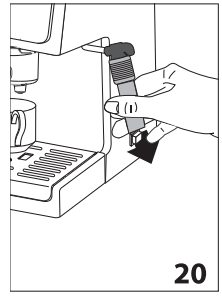
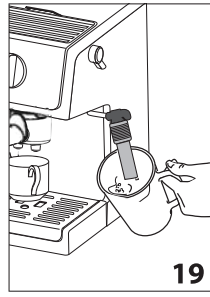
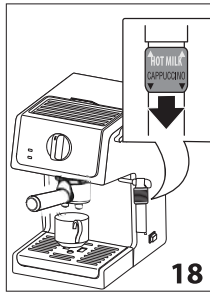
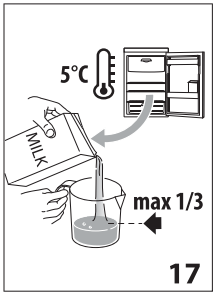

目 录

基本安全警告	6	如何制作卡布奇诺	10
安全警告	7	制作玛奇朵	10
使用说明	7	每次制作完卡布奇诺后的清洁	10
机器检查	7	热水	11
描述	7	清洁	11
机器描述	7	清洁机器	11
控制面板描述	7	清洁滴水盘	11
配件描述	7	清洁咖啡过滤器	11
机器的安装	8	清洁咖啡流出口	11
机器的连接	8	清洁水箱	12
水箱装水	8	除垢	12
机器的设置	8	技术参数	12
自动关机	8	机器的废旧处理	12
制作更热咖啡的小贴士	8	故障排除	13
马克杯/玻璃杯盘	9	名称和产品中有害物质的含量	14
如何用咖啡粉制作意式浓缩咖啡	9		
如何使用易理包制作意式浓缩咖啡	9		

基本安全警告

- 有心理、身体或者感官障碍、或不具备足够的经验或者知识的人员（包括儿童）不允许使用该电器，除非有对他们的安全负责的人密切监督并进行指导。
- 确保儿童不玩弄该电器。
- 指定用途：本机器的设计用途是制作咖啡、含牛奶饮品和热水。除此之外的用途都是不正确的，因而具有危险性。制造商对不恰当使用机器造成的危险不负有责任。
- 机器使用后加热部件的表面会持续发烫，机器外部也会根据使用情况持续发烫几分钟。
- 如需清洁机器，请参考“清洁”章节的描述。
- 没有监督的情况下，儿童不能清洁和维护该电器。
- 清洁时，切勿将机器浸入水中。
- 警告：请勿使用碱性清洁剂清洁机器，以避免对机器造成损坏，请用柔软的抹布和温和洗涤剂进行清洁。
- 这只是一台家用电器，并不适用于以下场所：商场的员工餐厅，办公室或其他工作环境；牧场旅馆；旅馆、汽车旅馆或其他住宅性环境的住客；家庭式旅馆。
- 如果机器的插头和电源线损坏，必须由德龙指定的售后服务人员进行更换，以避免各种危险。
- 如果机器配有可移除式电源线：请避免水溅到机器背面的电源线连口和电源插座。
- 咖啡机使用过程中，请勿将其放置于橱柜中。

安全警告



危险! 不遵守该警告可能导致触电伤害，也许会危及生命。

这是一台电器设备，不恰当使用可能导致触电。

因此您应该遵守以下安全警告：

- 切勿湿的手或湿的脚接触本机。
- 切勿湿的手接触插头。
- 确保能随时接近电器使用的插座，必要时能按下电器插头。
- 只能从插座上直接拔下电源插头，切勿拉扯电源线，以免损坏电源线。
- 要完全断开电器电源，请从插座拔下电源插头。
- 如果机器发生故障，请勿试图自己检修机器。

关闭电源，从插座拔下电源插头，并与售后服务中心联系。

- 在清洁机器前，请先关闭机器，然后从插座拔下电源插头，并待机器冷却。



重要：不遵守该警告可能导致人身伤害或损坏机器。

各种包装（塑料袋、聚苯乙烯泡沫塑料）必须远离儿童存放。



烫伤危险! 不遵守该警告可能会导致烫伤或烧伤。

本机可制作热水，制作热水的过程中可能会产生蒸汽。

请避免接触飞溅的热水或者热蒸汽。

使用说明

使用本机器之前请仔细阅读此说明书。不遵循本机器使用说明可能导致烧伤或者损坏电器。

制造商对未遵循说明书正确使用本机器引起的损害概不负责。



请注意：

请保存本说明书。

如果转让该机器给其他人，请确保将说明书同时附送。

机器检查

拆开包装后，确保机器完好无损，所有的配件齐全。

如发现机器有损，请勿使用，并与德龙售后服务中心联系。

描述

机器描述

（第1页-A）

- A1、可拆卸式水箱
- A2、暖杯盘
- A3、水箱仓
- A4、配件固定槽（咖啡过滤器）
- A5、顶盖
- A6、蒸汽/热水旋钮
- A7、卡布奇诺发泡器（不同型号此部件有差异）
- A8、卡布奇诺喷嘴
- A9、蒸汽/热水流出口
- A10、卡布奇诺发泡器选择环（仅限部分型号）
- A11、开/关键
- A12、水箱水位视窗
- A13、咖啡流出口
- A14、马克杯/玻璃杯盘（仅限部分型号）
- A15、滴水盘（不同型号此部件有差异）
- A16、滴水盘水位指示浮标（仅限部分型号）
- A17、咖啡杯盘（仅限部分型号）

控制面板描述

（第2页-B）

- B1、模式选择旋钮
- B2、OK指示灯
- B3、开启指示灯I

配件描述

（第2页-C）

- C1、过滤器手柄
- C2、1杯咖啡过滤器（配备网孔过滤器）
- C3、2杯咖啡过滤器（配备网孔过滤器）
- C4、易理包过滤器
- C5、咖啡粉量勺/压粉器
- C6、除垢液（如未包含，可向德龙授权的售后服务中心购买）
- C7、软水过滤器（如未包含，可向德龙授权的售后服务中心购买）

机器的安装



重要!

当您安装机器时，请遵守以下安全警告：

- 水渗进机器里面会损坏机器。
切勿将机器放置在水龙头或水槽的附近。
- 如机器内部的水中结冰，会损坏机器。
切勿将机器放置一个室温低于0℃的房间内
- 切勿将机器的电源线放置在锋利物体的边缘或热的物体的表面（如电子加热面板）。
- 机器会释放一些热量。
机器放置的工作台面，机器的顶部上方至少留3厘米的空间，两侧及后部与墙面至少留15厘米的空间。

机器的连接



危险!

检查所使用的电源电压与机器铭牌所标示的电源电压是否一致，并确保有效接有地线，且最小电流为10安培。如果电源插座与机器插头不匹配，请由专业合格的电工替换插座。

水箱装水

- 1、打开机器顶盖(如图1)，向上提取出水箱(如图2)
- 2、在水箱中注入清水，请注意加水量切勿超过水箱上标注的MAX（最高位置）线（如图3）。
将水箱装回机器，并轻轻按一下，打开水箱底部的阀门。
- 3、更简单的方法，可无需取出水箱，直接用水壶往水箱里倒水。



重要!

切勿在水箱无水或未安装水箱的情况下使用机器。
请通过水箱水位视窗（A12）检查水箱的水位。

机器的设置



重要：每次打开机器时，请确保模式选择旋钮(B1)旋转至“1”的位置(待机)。

- 1、按开/关键开启机器(如图4)，开启灯I亮起。
- 2、将需要的咖啡过滤器放入过滤器手柄(如图5)。
- 3、请勿在过滤器手柄内放入咖啡粉，将过滤器手柄连接到机器上。
- 4、在咖啡流出口的下方放置一个0.5升的容器，在卡布奇诺发泡器的下方放置一个0.5升的容器。
- 5、等到OK指示灯亮起后（如图8）立刻将模式选择旋钮旋转至 ☕/☕ 位置(如图9)，从咖啡流出口释放约一半容器容量的水。
- 6、将蒸汽旋钮旋转至 ☕/☕ 位置(如图10)，从卡布奇诺发泡器释放约一半容器容量的水。
- 7、将蒸汽旋钮旋转至“0”的位置，将模式选择旋钮旋转至“1”的位置（待机状态）。
- 8、清空2个容器后再放回咖啡流出口和卡布奇诺发泡器下方，再次操作第5至第7步步骤。
此时机器可以开始使用了。

自动关机

当机器在一定时间内未使用（每个型号的时间不一致），机器会自动关机（开启指示灯熄灭）。

制作更热咖啡的小贴士

为了在恰当的温度制作意式浓缩咖啡，需要按如下步骤预热咖啡机：

- 1、按下开/关键开启机器(开启指示灯亮起)(如图4)，将过滤器手柄安装到机器上，但不加咖啡粉(如图6)。
- 2、在过滤器手柄下方放置一个杯子。请使用即将制作咖啡的杯子，从而可以将其预热。
- 3、等到OK指示灯亮起后(如图8)立刻将模式选择旋钮旋转至 ☕/☕ 位置，让水流出直至OK指

示灯熄灭，然后将旋钮旋转至“1”的位置停止水流。

4、清空杯子，等到OK指示灯再次亮起后重复第三步操作。

(移除过滤器手柄的时候有一点无害的蒸汽溢出是正常的)。

马克杯/玻璃杯盘 (部分型号有此功能)



如果您使用高的杯子或玻璃杯 (例如，制作美式咖啡或玛奇朵)，取出滴水盘后将杯子直接放置在马克杯/玻璃杯盘上 (A14-如图11)。

当您制作完咖啡后，请将滴水盘放回原位置。

如何用咖啡粉制作意式浓缩咖啡



重要：每次开启机器时，请确认模式选择旋钮 (B1) 旋转至“1”的位置 (待机模式)。

1、将咖啡过滤器 (C2或C3) 装到过滤器手柄中 (如图6)。请确认可移除的网孔过滤器已正确安装；如未正确安装，请将网孔过滤器放置在咖啡过滤器中，尽可能向下按压。如需制作1杯意式浓缩咖啡，请使用底部标有  图标的咖啡过滤器；如需制作2杯意式浓缩咖啡，请使用底部标有  图标的咖啡过滤器。

2、如需制作1杯意式浓缩咖啡，请在咖啡过滤器中装入一量勺的咖啡粉 (大约7克) (如图12)。如需制作2杯意式浓缩咖啡，请在咖啡过滤器中装入2勺松散的咖啡粉 (大约6+6克)。每次加一点点的咖啡粉，以免咖啡粉溢出来。





重要：正确的操作方法是：在加咖啡粉之前，请先确认咖啡过滤器中没有上次制作咖啡时留下的咖啡残留物。

3、轻轻地倒入咖啡粉，并用压器轻轻地压一下 (如图13)。制作口味纯正的咖啡，压咖啡粉很重要。如果咖啡粉压得过紧，咖啡的流出

速度缓慢，且咖啡的油脂变深。如果咖啡粉压得过松，咖啡的流出速度很快，且咖啡的油脂会不足且颜色较淡。

4、去除咖啡过滤器边缘多余的咖啡粉，然后将过滤器手柄向右转紧 (如图6)，以避免水溢出。

5、在过滤器的出水口下方放置一个或两个杯子 (如图14)。建议在制作咖啡前，使用热水来冲洗一下咖啡杯，以达到暖杯的效果

6、确保OK指示灯亮起 (如图8) (如未亮起，等待指示灯亮起)，旋转模式选择旋钮至  /  位置。当所需的咖啡量达到后，将旋钮旋转至“1”的位置。

7、将过滤器手柄从右转到左边后移除手柄。



烫伤危险！ 为了避免溅出咖啡，切勿在机器制作咖啡时移除过滤器手柄。

8、按下开/关键关闭机器。

制作咖啡的时间请勿超过45秒。

如何使用易理包制作意式浓缩咖啡

1、参考“制作更热咖啡的小贴士”章节的描述预热机器，确保过滤器手柄已安装在机器上。这样可以制作出更热的咖啡。



请注意：请使用包装上有ESE标志的，符合ESE标准的易理包。ESE标准已被世界领先的制造厂商认可，可以简单又清洁地制作出意式浓缩咖啡。

2、在过滤器手柄中装入易理包过滤器 (C4 )。

3、装入易理包，尽量装在过滤器手柄的中心位置 (如图15)。安装易理包时请按照易理包包装上的标识进行正确的安装。

4、将过滤器手柄装入机器，尽可能往右扣紧 (如图6)。

5、按上一章节第5、6、7步进行操作。

如何制作卡布奇诺



重要：每次开启机器时，请确认模式选择旋钮（B1）旋转至“1”的位置（待机模式）。

1、按之前章节的描述制作一杯意式浓缩咖啡，并使用足够大的杯子

2、将旋钮旋转至  位置(如图16)，等待**OK**指示灯亮起。

3、与此同时在一个容器中倒入大约100毫升的牛奶，每制作一杯卡布奇诺需要100毫升的牛奶。

必须使用冰箱冷藏的牛奶(不是热牛奶！)。

选择容器时，需考虑到牛奶的容积会增加2-3倍（如图17）





请注意：建议使用冰箱冷藏的半脱脂的牛奶。

4、ECP3X.31系列：请确保卡布奇诺发泡器选择环(A10)在“CAPPUCCINO”（卡布奇诺）的位置(如图18)。

5、将装有牛奶的容器放置在牛奶发泡器的下方。

6、等待**OK**指示灯亮起，表示锅炉已达到制作蒸汽的理想温度。

7、将蒸汽旋钮旋转至  /  位置，制作几秒钟蒸汽以去除回路中的水。关闭蒸汽。

8、将牛奶发泡器浸入牛奶中约5毫米(如图19)，将蒸汽旋钮旋转到  /  位置。牛奶量开始增多，表面开始有奶泡。



9、当牛奶容量翻倍之后，将牛奶发泡器深深浸入牛奶中，持续加热牛奶。当达到所需温度（理想的温度为60℃）时，将蒸汽旋钮旋转至“0”的位置，将模式选择旋钮旋转至“1”的位置。

10、将奶泡倒入制作完咖啡的咖啡杯中。卡布奇诺已制作完毕。如需调至偏甜的口味，可洒少量的可可粉。



请注意：

•如需制作一杯以上的卡布奇诺，请先制作好所有的咖啡，然后再制作牛奶泡沫。

如需在制作完奶泡后制作咖啡，请先让锅炉冷却，否则咖啡会很烫。如需冷却锅炉，请在咖啡流出口下方放置一个容器，将模式选择旋钮旋转至  /  位置，释放水直至OK指示灯熄灭。将旋钮转回至“1”的位置，然后开始制作咖啡。

建议您制作蒸汽的时间不要超过60秒，切勿连续制作三次奶泡。

制作玛奇朵(热牛奶功能—仅限ECP3X.31系列)



如需制作无奶泡的热牛奶，请按照前一章节的描述，将卡布奇诺发泡器(A10)向上拉至“HOT MILK”（热牛奶）位置。

每次制作完卡布奇诺后的清洁



重要！为了卫生，请在每次使用后清洁牛奶发泡器。

具体的操作步骤如下：

1、旋转蒸汽旋钮至  /  位置，释放几秒钟的蒸汽（按照“如何制作卡布奇诺”章节的第2、6和7点的描述进行操作）。此操作可以去除残留在机器内的牛奶残留物。将蒸汽旋钮旋转至“0”的位置，将模式选择旋钮旋转至“1”的位置，关闭机器。

2、等待一段时间使热水流出口冷却。向外旋转热水流出口并往下拉后移除(如图20)。

ECP3X.31系列

3、将卡布奇诺喷嘴往下拉后移除。(如图21)

4、将卡布奇诺发泡器选择环往上推，确保图22中箭头指示的2个孔没有被堵塞。





如有需要，请用别针清洁。

5、将热水流出口装回机器，将卡布奇诺发泡器选择环向下拉，将热水流出口装回喷嘴，旋转并向上推直至链接。

ECP3X. 21系列

- 3、将卡布奇诺喷嘴往下拉后移除。(如图23)
- 4、确保图24所示的卡布奇诺喷嘴的2个孔没有被堵塞。如有需要,请用别针清洁。
- 5、将热水流出口装回机器,将其装回卡布奇诺喷嘴旋转并向上推直至连接。

热水

- 1、按开/关键开启机器(如图4)。等待OK指示灯亮起。
- 2、将容器放置在卡布奇诺发泡器下方。
- 3、当**OK**指示灯亮起后,将模式选择旋钮旋转至  /  位置,同时将蒸汽旋钮旋转至  /  位置。热水从卡布奇诺发泡器流出。
- 4、如需停止热水流出,旋转蒸汽旋钮至“0”的位置,将模式选择旋钮旋转至“1”的位置。制作热水的时间不可以超过60秒。

清洁

清洁机器

机器以下部件必须经常清洁:

- 滴水盘 (A15)
- 咖啡过滤器 (C2, C3, C4)
- 咖啡流出口 (A13)
- 水箱 (A1)
- 卡布奇诺发泡器(A7), 参考“每次制作完卡布奇诺后的清洁”章节的描述



重要!

- 请勿使用有溶解性、腐蚀性的除垢液或酒精清洁咖啡机。
- 请勿使用金属物体去除结垢或咖啡沉淀物,以免擦伤金属或塑料表面。



危险! 请勿将咖啡机浸没在水中。这是一台电器。



请注意:

如果机器超过3-4天未使用,在使用前,我们强烈建议您参考“机器的设置”章节的描述进行一次冲洗循环。

清洁滴水盘



重要! 仅限部分型号

滴水盘配有一个水位指示浮标(红色),表示其水位。

当红色的水位指示浮标从滴水盘中浮起来时(如图25),必须清空并清洗滴水盘。否则水就会从滴水盘的边缘溢出来,损坏机器及其附近区域。

- 1、取出滴水盘(如图26)。
- 2、仅限部分型号:取出杯盘格栅,清空滴水盘中的水,并用布将滴水盘擦干净,然后再组装好滴水盘。
- 取出马克杯/玻璃杯盘(A14),用水清洁后擦干再安装回机器。
- 3、将滴水盘装回机器。

清洁咖啡过滤器

每周清洁咖啡过滤器:

1杯或2杯咖啡过滤器:

1. 往外拉过滤器拉环,取出网孔过滤器(如图27);
2. 用流水冲洗过滤器(如图28);
3. 确保过滤器上的小孔没有被堵塞。如有必要,请用牙签清理(如图28、图29);
4. 将网孔过滤器放置在咖啡过滤器中,尽可能向下按压。

易理包过滤器

用流水冲洗过滤器。确保过滤器上的小孔没有被堵塞。如有必要,请用牙签清理(如图28、图29)。

清洁咖啡流出口

大约每制作300杯咖啡以后，咖啡流出口就需要按照如下步骤进行清洁：

- 1、确保机器不发烫且机器电源线已从主电源上拔出。
- 2、用螺丝刀拧开固定在咖啡流出口上的螺丝(如图28)。
- 3、取出咖啡流出口上的过滤片。
- 4、用湿布清洁流出口（如图28）。
- 5、用热水彻底冲洗流出口过滤片。确保小孔未被堵塞。如有必要，用别针清洁。
- 6、用清水冲洗，并反复擦拭。
- 7、将咖啡流出口安装回机器，确保垫圈正确安装。

如未按照以上步骤操作清洁咖啡流出口会使保修失效。

清洁水箱

- 1、定期（大约一个月一次）和在更换软水过滤器（C7，如配备）的时候用湿布和中性洗涤剂清洁水箱。
- 2、移除软水过滤器（如配备）并用流水冲洗。
- 3、安装软水过滤器（如配备），在水箱中注入清水，安装水箱。
- 4、（如配备软水过滤器）释放约100毫升的水。

除垢





建议您在制作200杯咖啡后对机器进行除垢。

我们建议您使用德龙的除垢液（C6）。

操作步骤如下：





- 1、在水箱中倒入除垢液，倒入的除垢液请按包装上的说明进行稀释。
- 2、按下开/关键。
- 3、确保过滤器手柄没有安装到机器上，并在牛奶发泡器的下方放置一个容器。

4、等待OK指示灯亮起。

5、将模式选择旋钮旋转至/位置，释放水箱中大约1/4的水。然后将蒸汽旋钮旋转至/位置，从卡布奇诺发泡器释放水。将模式选择旋钮旋转至“1”的位置停止放水，然后等待5分钟，让溶剂发挥作用。

6、再重复操作第5步3次，直至水箱清空。

7、为了确保水箱中无除垢液的残留，彻底冲洗水箱后注入清水（无除垢液）。

8、将模式选择旋钮旋转至/位置。释放一段时间水后，将蒸汽旋钮旋转至/位置，从卡布奇诺发泡器释放水，释放水直至水箱清空。

9、再重复操作第7、8步。

技术参数

参考铭牌

机器的废旧处理

本机器废弃时不能按一般的家电进行废旧处理，需将机器交给专门的垃圾分类收集中心进行处理。



故障排除

以下是机器可能发生的一些故障。

如果按照描述依旧不能解决，请联系售后服务中心。

问题	可能原因	解决方法
不出咖啡	水箱缺水	水箱加水
	过滤器手柄网孔堵塞	清洁过滤器手柄网孔
	咖啡流出口堵塞	按“清洁”章节的描述进行清洁
	机器需要进行除垢	按“除垢”章节的描述进行除垢
咖啡从边缘流出，而不从咖啡流出口流出	过滤器手柄安装不正确或太脏	重新正确安装过滤器手柄，并拧紧
	垫圈失去弹性或者太脏了	联系售后服务中更换垫圈
	过滤器手柄上的咖啡流出口堵塞	清洁过滤器手柄上的咖啡流出口
咖啡过冷	制作咖啡时OK指示灯未亮起	等待OK指示灯亮起后制作咖啡
	事先未预热	按“制作更热咖啡的小贴士”章节的描述进行预热
	杯子未预热	用热水预热杯子
	回路中有水垢	按“除垢”章节的描述进行除垢
咖啡机声音过大	水箱缺水	水箱加水
	水箱未正确安装，底部阀门未打开	轻轻向下按压水箱，打开底部阀门
	水箱连接处有气泡	按“热水”章节的描述，直至水流出。
咖啡油脂颜色深(咖啡从咖啡流出口流出很慢)	咖啡粉挤压过紧	减轻压粉的力度
	咖啡粉用量过多	减少咖啡粉的用量
	咖啡流出口堵塞	按“清洁咖啡流出口”章节的描述清洁咖啡流出口
	咖啡过滤器和网孔过滤器堵塞	按“清洁咖啡过滤器”章节的描述清洁咖啡过滤器
	咖啡粉研磨过细	使用意式浓缩咖啡专用咖啡粉
	咖啡粉过细或受潮	使用意式浓缩咖啡专用咖啡粉，并确保咖啡粉没有受潮
	使用了错误的咖啡粉类型	更换咖啡粉类型
制作卡布奇诺的时候没有奶泡	ECP3X. 31系列:卡布奇诺发泡器选择环在“HOT MILK”(热牛奶)的位置	ECP3X. 31系列:将卡布奇诺发泡器选择环调整至“CAPPUCCINO”(卡布奇诺)的位置
	牛奶不够冷	请使用冰箱冷藏温度的牛奶
	卡布奇诺发泡器过脏	按“每次制作完卡布奇诺后的清洁”章节的描述清洁卡布奇诺发泡器
	回路中有水垢	按“除垢”章节的描述进行除垢
机器关机	自动关机功能启动	按开/关键开启机器
机器开机后几秒钟又关机	模式选择旋钮没有调至“I”的位置(待机)	将模式选择旋钮旋转至“I”的位置，然后按开/关键开启机器

名称和产品中有害物质的含量

Name and content of hazardous substances in products

组件名称 Components Name	有害物质 Hazardous substances					
	铅 Lead (Pb)	汞 Mercury (Hg)	镉 Cadmium (Cd)	六价铬 Hexavalent Chromium (Cr (VI))	多溴联苯 Polybrominated biphenyls (PBB)	多溴二苯醚 Polybrominated diphenyl ethers (PBDE)
塑料外壳和底盘 Plastic enclosure and chassis	○	○	○	○	○	○
印刷电路板组装 Printed Circuit Board Assembly	X	○	○	○	○	○
电机、阀门 Motors, valves	X	○	○	○	○	○
电缆和电线 Cable and wiring	○	○	○	○	○	○
金属零件 Metal parts	X	○	X	○	○	○

本表格依据SJ/T 11364 的规定编制。This table is prepared in accordance with the provisions of SJ/T 11364.

○ :表示该有害物质在该部件所有均质材料中的含量均在GB/T 26572规定的限量要求以下。

○ :The content of such hazardous substance in all homogeneous material of such components is below the limit required by GB/T 26572.

X:表示该有害物质至少在该部件的某一均质材料中的含量超出GB/T 26572规定的限量要求。主要是由于受技术发展水平限制,暂时无法实现替代或减量化,但这部分零部件本身不直接与食物接触,正常使用条件下不会对使用者造成任何健康影响。我们的产品均通过食品安全监测,可安心使用。

X: The content of such hazardous substance in a certain homogeneous material of such components is beyond the limit required by GB/T 26572, mainly due to the level of technical development situation, temporarily unable to achieve replacement or reduction.

The above cited parts marked with "X" are related to components non in contact with the food.

All parts of the appliance in direct contact with the food are safe under normal conditions of use.

FUNDAMENTAL SAFETY WARNINGS

- The appliance is not intended for use by persons (including children) with reduced physical, sensory or mental capabilities, or lack of experience and knowledge, unless they have been given supervision or instruction concerning use of the appliance by a person responsible for their safety.
- Children should be supervised to ensure that they do not play with the appliance.
- Designated use: this appliance is designed and made to prepare beverages based on coffee, milk and hot water. Any other use is considered improper and thus dangerous. The manufacturer is not liable for damage deriving from improper use of the appliance.
- The surface of the heating element remains hot after use and the outside of the appliance may retain the heat for several minutes depending on use.
- To clean, follow the instructions in section "CLEANING".
- Cleaning and user maintenance shall not be made by children without supervision.
- Never clean by immersing the appliance in water.
- IMPORTANT: to prevent damage to the appliance, do not clean with alkaline detergents; use a soft cloth and, where applicable, neutral detergent.
- This is an household appliance only. It is not intended to be used in: staff kitchen areas in shops, offices and other working environments; farm houses; by clients in hotels, motels and other residential type environments; bed and breakfast type environments.
- If the plug or power cord is damaged, it must be replaced by customer services only to avoid all risk.
- Appliances with removable cord: avoid splashes of water on the power cord connector or socket at the back of the appliance.
- IMPORTANT: Models with glass surfaces: do not use the appliance if the surface is cracked.
- Coffee-maker shall not be placed in a cabinet when in use.

FOR EUROPEAN MARKETS ONLY:

- This appliance can be used by children aged from 8 years and above if they have been given supervision or instruction concerning use of the appliance in a safe way and understand the hazards involved.
Cleaning and user maintenance shall not be made by children unless they are older than 8 and supervised.
- Keep the appliance and power cord away from children under eight years of age.

- Appliances can be used by persons with reduced physical, sensory or mental capabilities or lack of experience and knowledge if they are supervised or have been given instruction concerning use of the appliance in a safe way and if they understand the hazards involved.
- Children shall not play with the appliance.
- Always unplug the appliance when left unattended and before assembly, taking apart or cleaning.



Surfaces marked with this symbol become hot during use (the symbol is present in certain models only).

SAFETY WARNINGS



Danger! Failure to observe the warning may result in life threatening injury by electric shock.

This is an electrical appliance and may cause electrical shocks.

You should therefore follow these safety warnings:

- Never touch the appliance with damp hands or feet.
- Never touch the plug with damp hands.
- Make sure the socket used is freely accessible at all times, enabling the appliance to be unplugged when necessary.
- Unplug directly from the plug only. Never pull the cord as you could damage it.
- To disconnect the appliance completely you must unplug it from the mains socket.
- If the appliance is faulty, do not attempt to repair. Turn it off, unplug from the mains socket and contact Customer Services.
- Before cleaning the appliance, turn it off, unplug from the mains socket and allow to cool.



Important: Failure to observe the warning could result in injury or damage to the appliance.

Keep all packaging (plastic bags, polystyrene foam) away from children.



Danger of burns! Failure to observe the warning could result in scalds or burns.

This appliance produces hot water and steam may form while it is in operation.

Avoid contact with splashes of water or hot steam.

Designated use

This appliance is designed and made to prepare coffee and heat drinks.

Any other use is considered improper and thus dangerous.

The manufacturer is not liable for damage deriving from improper use of the appliance.

Instruction for Use

Read this Instruction for Use carefully before using the appliance. Failure to follow this Instruction for Use may result in burns or damage to the appliance.

The manufacturer is not liable for damage deriving from failure to respect this Instruction for Use.



Please note:

Keep this Instruction for Use.

If the appliance is passed to other persons, they must also be provided with this Instruction for Use.

Checking the appliance

After removing the packaging, make sure the product is complete and undamaged and that all accessories are present.

Do not use the appliance if it is visibly damaged.

Contact De'Longhi Customer Services.

DESCRIPTION

Description of the appliance

(page 3 - A)

- A1. Removable water tank
- A2. Cup tray
- A3. Water tank compartment
- A4. Guides for accessories holder (coffee filters)
- A5. Lid
- A6. Steam/hot water dial
- A7. Cappuccino maker (**varies according to model)
- A8. Cappuccino maker nozzle
- A9. Spout
- A10. Cappuccino maker selection ring (*certain models only)
- A11. ON/OFF switch
- A12. Tank water level viewing window
- A13. Boiler outlet
- A14. Mugs or glasses tray (*certain models only)
- A15. Drip tray (**varies according to model)

A16. Drip tray water level indicator (*certain models only)

A17. Cup tray (*certain models only)

Description control panel

(page 3 - B)

B1. Mode selector dial

B2. **OK** light

B3. Power light **I**

Description of the accessories

(page 3 - C)

C1. Filter holder

C2. 1 coffee froth filter (with removable perforated filter)

C3. 2 coffee froth filter (with removable perforated filter)

C4. ESE pod froth filter

C5. Measure/pressure

C6. Descaler (***)not included, can be purchased from authorised Customer Services)

C7. Water softener filter (***)not included, can be purchased from authorised Customer Services)

INSTALLING THE APPLIANCE

Important!

When you install the appliance, you should respect the following safety warnings:

- Water penetrating the coffee machine could cause damage.
Do not place the appliance near taps or sinks.
- The appliance could be damaged if the water it contains freezes.
Do not install the appliance in a room where the temperature could drop below freezing point.
- Arrange the cord in such a way that it cannot be damaged by sharp edges or contact with hot surfaces (e.g. electric hot plates).
- The appliance gives off heat.
After positioning the appliance on the worktop, leave a space of at least 3 cm between the surfaces of the appliance and the side and rear walls and at least 15 cm above the coffee machine.

Connecting the appliance

Danger!

Check that the mains power supply voltage corresponds to that indicated on the rating plate on the bottom of the appliance. Connect the appliance to an efficiently earthed and correctly installed socket with a minimum current rating of 10A only. If the power socket does not match the plug on the appliance, have the socket replaced with a suitable type by a qualified electrician.

FILLING THE WATER TANK



1. Open the lid of the appliance (fig. 1) then extract the tank by pulling upwards (fig. 2);
2. Fill the tank with fresh clean water, taking care not to exceed the MAX level (fig. 3).
Put the tank back in the appliance, pressing lightly to open the valves located on the bottom of the tank.
3. More simply, the tank can also be filled without removing it, pouring the water directly from a jug.

Important:

Never operate the appliance without water in the tank or without the tank.

Check the level of water in the tank through the viewing window (A12).

SETTING UP THE APPLIANCE

1. Turn the appliance on by pressing the ON/OFF button (fig. 4): the power light **I** comes on.
2. Insert the required coffee filter in the filter holder (fig. 5).
3. Attach the filter holder onto the machine without filling it with ground coffee (fig. 6).
4. Place a 0.5 litre container under the boiler outlet and another 0.5 litre container under the cappuccino maker.
5. Wait until the OK light comes on (fig. 8) and immediately afterwards turn the mode selector dial to the  position (fig. 9) and deliver about half the tank through the filter holder.
6. Then turn the steam dial to the /  position (fig. 10) and deliver all the water remaining in the tank through the cappuccino maker.
7. Turn the steam dial back to the **0** position and the mode selector dial to the **I** position (STAND-BY).
8. Empty the two containers and replace them under the boiler outlet and the cappuccino maker and repeat points 5-6-7.

Now the appliance is ready for use.

Auto-off

If the appliance is not used for a certain period of time (variable according to the model), it turns off automatically (the power light goes out).

Tips for a hotter coffee

To make espresso coffee at the right temperature, the coffee maker should be preheated as follows:

1. Turn the appliance on by pressing the ON/OFF switch (the ON light comes on) (fig. 4) and attach the filter holder to the appliance without adding pre-ground coffee (fig. 6).

- Place a cup under the filter holder. Use the same cup as will be used to prepare the coffee in order to preheat it.
- Wait until the OK light comes on (fig. 8) and immediately afterwards turn the selector dial to the  position (fig. 9) and let water discharge until the OK light turns off, then interrupt by turning the dial to the I position.
- Empty the cup, wait until the OK light comes on again and then repeat the same operation.



(It is normal for a small and harmless puff of steam to be given off when removing the filter holder).

Mugs or glasses tray (some models only)

If you are using tall cups or glasses (for example, to make long coffee or macchiato), extract the drip tray and rest the cup directly on the mugs or glasses tray (A14 - fig. 11).

Once you have made your coffee, put the drip tray back in position.

HOW TO MAKE ESPRESSO COFFEE USING PRE-GROUND COFFEE

- Place the ground coffee filter (C2 or C3) in the filter holder. Check that the removable perforated filter is correctly positioned: if not, place the perforated filter inside the filter and press as far as it goes. Use the  filter to make one coffee or the  filter to make two coffees.
- To make just one coffee, place one level measure of pre-ground coffee (about 7 g) in the filter. (fig. 12). To make two coffees, place two loosely filled measures (about 6+6 g) of pre-ground coffee in the filter. Fill the filter a little at a time to prevent the pre-ground coffee from overflowing.

 **Important:** For correct operation, before filling with pre-ground coffee, make sure there are no coffee residues left in the filter from the last time you made coffee.

- Distribute the pre-ground coffee evenly and press lightly with the presser (fig. 13). Correct pressing of the pre-ground coffee is essential to obtain a good espresso. If pressing is excessive, coffee delivery will be slow and the froth will be dark. If pressing is too light, coffee delivery will be too rapid and the froth will be skimpy and light coloured.
- Remove any excess coffee from the rim of the filter holder and attach to the appliance. Turn the handle firmly towards the right (fig. 6) to avoid water leaking out.
- Place the cup or cups under the filter holder spouts (fig. 14). You are recommended to warm the cups before making coffee by rinsing them with a little hot water.
- Make sure the OK light (fig. 8) is on (if off, wait until it comes on), then turn the mode selector dial to the

 position. When the desired amount of coffee has been delivered, turn the dial to the I position.

- To remove the filter holder, turn the handle from right to left.

 **Danger of burns!** To avoid splashes, never remove the filter holder while the appliance is delivering coffee.

- To turn the appliance off, press the ON/OFF button.

HOW TO PREPARE ESPRESSO COFFEE USING PODS

- Preheat the appliance as described in the section "Tips for a hotter coffee", making sure the filter holder is attached. This obtains a hotter coffee.

 **Please note:** Use pods conforming to the ESE standard, indicated on the pack by the following symbol.



The ESE standard is a system accepted by leading pod producers and enables espresso coffee to be prepared simply and cleanly.

- Place the pod coffee filter (C4 ) in the filter holder.
- Insert the pod, centring it as far as possible on the filter (fig. 15). Always follow the instructions on the pod pack to position the pod on the filter correctly.
- Attach the filter holder to the appliance. Always turn as far as it will go (fig. 6).
- Proceed as in points 5, 6 and 7 in the previous section.

HOW TO PREPARE CAPPUCCINO COFFEE

- Prepare the espresso coffees as described in the previous sections, using sufficiently large cups.
- Turn the selector to the  position (fig. 16) and wait until the OK light comes on.
- In the meantime, fill a recipient with about 100 grams of milk for each cappuccino to be prepared. The milk must be at refrigerator temperature (not hot!). In choosing the size of the recipient, bear in mind that the milk doubles or triples in volume (fig. 17).

 **Please note:** You are recommended to use semi-skimmed milk at refrigerator temperature.

- ECP 3X.31 only:** Make sure the cappuccino maker selection ring (A10) is in the "CAPPUCCINO" position (fig. 18).
- Place the recipient containing the milk under the cappuccino maker.
- Wait until the OK light comes on. This indicates that the boiler has reached the ideal temperature for steam production.
- Open the steam by turning the steam selector to the  position for a few seconds to eliminate any water in the circuit. Close the steam.
- Immerse the cappuccino maker in the milk for about 5 mm (fig. 19) and turn the steam dial to the  position.

The milk now starts to increase in volume and take on a creamy appearance.

- When the milk has doubled in volume, immerse the cappuccino maker deeply and continue heating the milk. When the required temperature (the ideal is 60°C) is reached, interrupt steam delivery by turning the steam dial to the **0** position and the mode selector dial to the **I** position.
- Pour the frothed milk into the cups containing the coffee prepared previously. The cappuccino is ready. Sweeten to taste and if desired, sprinkle the froth with a little cocoa powder.



Please note:

- To prepare more than one cappuccino, first make all the coffees then at the end prepare the frothed milk for all the cappuccinos.
- To make coffee again after the milk has been frothed, first cool the boiler, or the coffee will be burnt. To cool it, place a container under the boiler outlet, turn the mode selector dial to the position and deliver water until the OK light goes off. Return the selector to the **I** position and then proceed to make coffee.

You are recommended to deliver steam for a maximum of 60 seconds and never to froth milk more than three times consecutively.

MAKING MACCHIATO (HOT MILK - MODEL ECP35X.31 ONLY)

To make hot milk without froth, proceed as described in the above section, making sure the ring on the cappuccino maker (A10) is positioned upwards in the "HOT MILK" position.

CLEANING THE CAPPUCCINO MAKER AFTER EVERY USE



Important! or hygiene reasons, the cappuccino maker

should always be cleaned after use.

Proceed as follows:

- Turn the steam dial to the position to deliver a little steam for a few seconds (points 2, 6 and 7 of the section "How to prepare cappuccino coffee"). This causes the cappuccino maker to discharge any milk left inside. Turn the appliance off by turning the steam dial to the **0** position and the mode selector dial to the **I** position.
- Wait a few minutes for the cappuccino maker to cool down. Turn the cappuccino maker outwards and remove it by pulling it downwards (fig. 20).

Model ECP3X.31

- Remove the nozzle downwards (fig. 21).
- Push the ring upwards and make sure the two holes shown by the arrows in fig. 22 are not blocked. If necessary, clean with a pin.

- Replace the nozzle, move the ring downwards and put the cappuccino maker back on the nozzle, turning it and pushing it upwards until it is attached.

Model ECP3X.21

- Remove the cappuccino maker nozzle downwards (fig. 23).
- Make sure the holes in the cappuccino maker shown in fig. 24 are not blocked. If necessary, clean with a pin.
- Reinsert the nozzle and replace the cappuccino maker on the nozzle, turning it and pushing it upwards until it is attached.

HOT WATER

- Press the ON/OFF button (fig. 4) to turn the appliance on. Wait for the **OK** light to come on.
- Place a recipient under the cappuccino maker.
- When the **OK** light comes on, turn the mode selector dial to the position and at the same time turn the steam dial to the position. Hot water comes out of the cappuccino maker.
- To stop the flow of hot water, turn the steam dial to the **0** position and the mode selector dial to the **I** position.

You should not deliver hot water for more than 60 seconds.

CLEANING

Cleaning the machine

The following parts of the machine must be cleaned regularly:

- the drip tray (A15);
- the coffee filters (C2, C3 and C4);
- the boiler outlet (A13);
- the water tank (A1);
- the cappuccino maker (A7) as described in the section "Cleaning the cappuccino maker after every use".



Important!

- Do not use solvents, abrasive detergents or alcohol to clean the coffee machine.
- Do not use metal objects to remove encrustations or coffee deposits as they could scratch metal or plastic surfaces.



Danger! Never immerse the coffee maker in water. It is an electrical appliance.



Please note:

If the appliance is not used for more than 3/4 days, before using it again, we strongly recommend you perform a rinse cycle as described in the section "Setting up the appliance".

Cleaning the drip tray



Some models only:

The drip tray is fitted with a level indicator (red) showing the level of water it contains.

Before the indicator protrudes from the cup tray (fig. 25), the drip tray must be emptied and cleaned, otherwise the water may overflow the edge and damage the appliance, the surface it rests on or the surrounding area.

1. Remove the drip tray (fig. 26).
2. **Some models only:** Remove the cup grille, empty the water and clean the tray with a cloth, then reassemble the drip tray.
Extract the mugs or glasses tray (A14), clean with water, dry and put back in the machine.
3. Put the drip tray back in place.

Cleaning the coffee filters

Clean the coffee filters weekly:

1 and 2 cup filters

1. Extract the perforated filter by pulling the tab (fig. 27);
2. Rinse the filters under running water (fig. 28);
3. Make sure the holes are not blocked. If necessary, clean with a pin (figs. 28 and 29);
4. Place the perforated filter in the filter housing and press as far as it will go.

Pod filter

Rinse under running water. Make sure the holes are not blocked. If necessary, clean with a pin (figs. 28 and 29).

Cleaning the boiler outlet

After every 200 coffees, rinse the boiler outlet by delivering about 0.5 l of water from the boiler outlet.

Cleaning the water tank

1. Clean the water tank regularly (about once a month) and whenever you replace the water softener filter (C7, *if provided) with a damp cloth and a little mild washing up liquid.
2. Remove the filter (*if present) and rinse with running water.
3. Replace the filter (*if provided), fill the tank with fresh water and replace the tank.
4. (Models with water softener filter only) Deliver about 100 ml of water.

DESCALING

You are recommended to descale the coffee maker about every 200 coffees.

We recommend using commercially available De'Longhi (C6*) descaler.

Proceed as follows:

1. Fill the tank with the descaler solution, obtained by diluting the descaler with water following the instructions on the pack.
2. Press the ON/OFF button.
3. Make sure the filter holder is not attached and place a recipient under the cappuccino maker.
4. Wait until the **OK** light comes on.
5. Turn the mode selector dial to the / position and deliver about 1/4 of the solution in the tank. At intervals, turn the steam dial to the / position to deliver water from the cappuccino maker. Then interrupt delivery by turning the mode selector dial to the **I** position and leave the solution to work for about 5 minutes.
6. Repeat point 5 another 3 times, until the tank is empty.
7. To eliminate residues of descaler solution, rinse the tank well and fill it with clean water (without descaler).
8. Turn the selector to the / position. At intervals, turn the steam dial to the / position to deliver water from the cappuccino maker: deliver water until the tank is empty.
9. Repeat points 7 and 8.

TECHNICAL DATA

Mains voltage:	220-240V-50/60Hz
Absorbed power:	1100W
Size LxDxH:	185x244(329)x305 mm
Pressure:	15 bar
Water tank capacity:	1.1 l
Power cord length:	1300 mm
Weight:	3,8 kg

The appliance complies with the following EC directives:

- Stand-by European Regulation 1275/2008 and subsequent amendments;
- Materials and accessories coming into contact with food conform to European regulation 1935/2004.

DISPOSAL



The appliance must not be disposed of with household waste, but taken to an authorised waste separation and recycling centre.

TROUBLESHOOTING

Below is a list of some of the possible malfunctions.

If the problem cannot be resolved as described, contact Customer Services.

PROBLEM	POSSIBLE CAUSE	SOLUTION
No espresso coffee is delivered	No water in the tank	Fill the tank with water
	The holes in the filter holder are blocked	Clean the filter holder spout holes
	The espresso boiler outlet is blocked	Clean as described in the chapter "Cleaning"
	Scale in the water circuit	Descale as described in the "Descaling" section
The espresso coffee drips from the edges of the filter holder rather than the holes	The filter holder has been inserted incorrectly or is dirty	Attach the filter holder correctly and rotate firmly as far as it will go
	The espresso boiler gasket has lost elasticity or is dirty	Have the espresso boiler gasket replaced by Customer Services
	The holes in the filter holder spouts are blocked	Clean the filter holder spout holes
The espresso coffee is cold	The OK light is not on when the coffee is delivered	Wait until the OK light comes on
	No preheating was done	Pre-heat as indicated in the "Tips for a hotter coffee" section
	The cups were not preheated	Pre-heat the cups with hot water
	Scale in the water circuit	Descale as described in the section "Descaling"
The pump is excessively noisy	The water tank is empty	Fill the tank
	The tank is not correctly in place and the valve on the bottom is not open	Press the tank down lightly to open the valve on the bottom
	There are air bubbles in the tank connector	Follow the instructions given in the "Hot water" section until water is delivered
The coffee froth is too dark (delivered from the spout too slowly)	The pre-ground coffee is pressed down too firmly	Press the coffee down less firmly
	There is not enough pre-ground coffee	Reduce the quantity of pre-ground coffee
	The espresso boiler outlet is blocked	Clean as described in the section "Cleaning the boiler outlet"
	The filter or the perforated filter is blocked	Clean as described in the section "Cleaning the coffee filters"
	The pre-ground coffee is too fine or damp	Use only pre-ground coffee for espresso coffee makers and make sure it is not damp
	The wrong type of pre-ground coffee is being used	Use a different type of pre-ground coffee
The coffee has an acid taste	Inadequate rinsing after descaling	After descaling, rinse the appliance as described in the section "Descaling"

No milk froth is formed when making cappuccino	Model ECP3X.31: the ring is in the "HOT MILK" position	MODEL ECP3X.31: push the ring into the "CAPPUCCINO" position
	Milk not cold enough	Always use milk at refrigerator temperature
	Cappuccino maker dirty	Clean as described in the section "Cleaning the cappuccino maker"
	Scale in the water circuit	Descale as described in the section "Descaling"
The appliance switches off	Auto-off has been triggered	Press the ON/OFF button to turn the appliance on again
The appliance switches off a few seconds after switching on	The mode selector dial is not in the I position (Standby)	Turn the mode selector dial to the I position (Standby), then press the ON/OFF switch.

ELECTRICAL REQUIREMENTS (UK ONLY)

Before using this appliance ensure that the voltage indicated on the product corresponds with the main voltage in your home, if you are in any doubt about your supply contact your local electricity company.

The flexible mains lead is supplied connected to a B.S. 1363 fused plug having a fuse of 13 amp capacity. Should this plug not fit the socket outlets in your home, it should be cut off and replaced with a suitable plug, following the procedure outlined below.

Note: Such a plug cannot be used for any other appliance and should therefore be properly disposed of and not left where children might find it and plug it into a supply socket - with the obvious consequent danger.

N.B. We recommend the use of good quality plugs and wall sockets that can be switched off when the machine is not in use.

IMPORTANT: the wires in the mains lead fitted to this appliance are coloured in accordance with the following code: *Green and Yellow to Earth*

GREEN AND YELLOW
BLUE
BROWN

EARTH
NEUTRAL
LIVE

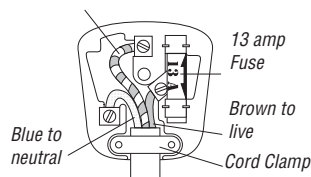

As the colours of the wires in the mains lead of this appliance may not correspond with the coloured markings identifying the terminals in your plug, proceed as follows:

- The wire which is coloured green and yellow must be connected to the terminal in the plug which is marked with the letter E or by the earth symbol  or coloured green or green and yellow.
- The wire which is coloured blue must be connected to the terminal which is marked with the letter N or coloured black.
- The wire which is coloured brown must be connected to the terminal which is marked with the letter L or coloured red.

When wiring the plug, ensure that all strands of wire are securely retained in each terminal. Do not forget to tighten the mains lead clamp on the plug. If your electricity supply point has only two pin socket outlets, or if you are in doubt, consult a qualified electrician.

Should the mains lead ever require replacement, it is essential that this operation be carried out by a qualified electrician and should only be replaced with a flexible cord of the same size.

After replacement of a fuse in the plug, the fuse cover must be refitted. If the fuse cover is lost, the plug must not be used until a replacement cover is obtained. The colour of the correct replacement fuse cover is that of the coloured insert in the base of the fuse recess or elsewhere on the plug. Always state this colour when ordering a replacement fuse cover. Only 13amp replacement fuses which are approved to B.S. 1362 should be fitted.

This appliance conforms to the Norms EN 55014 regarding the suppression of radio interference.

Warning - this appliance must be earthed



★若有任何需求请与下述地址联系：

☆邑隆贸易(上海)有限公司

地址：上海市普陀区中山北路3553号伸大厦2001-2016室

电话：021 3135 8858 传真：021 3135 8262 邮编：200062

客户热线：400 827 1668

网址：www.delonghi.com.cn