EMF2

MILK FROTHER

Instructions for use. Keep these instructions

Visit www.delonghiregistration.com to register
your product

Visit www.delonghi.com for a list of service centers
near you.

ELECTRIC CHARACTERISTICS

120 V ~ 60 Hz 500 W



MOUSSEUR À LAIT

Mode d'emploi . Conservez cette notice

Visitez www.delonghiregistration.com pour
enregistrer votre produit en ligne.

Visitez www.delonghi.com pour y voir une liste des
centres de réparation proches de chez vous.

CARACTÉRISTIQUES ÉLECTRIQUES

120 V ~ 60 Hz 500 W

BATIDOR DE LECHE

Repase y guarde estas instrucciones.

Lea cuidadosamente este instructivo antes de usar
su aparato.

Visite www.delonghiregistration.com para registrar
su producto en línea.

Visite www.delonghi.com para ver la lista de
centros de servicios cercanos a usted.

CARACTERISTICAS ELECTRICAS:

120 V ~ 60 Hz 500 W

DeLonghi

EN

page 9

FR

page 10

ES

page 14

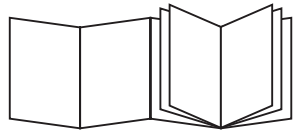

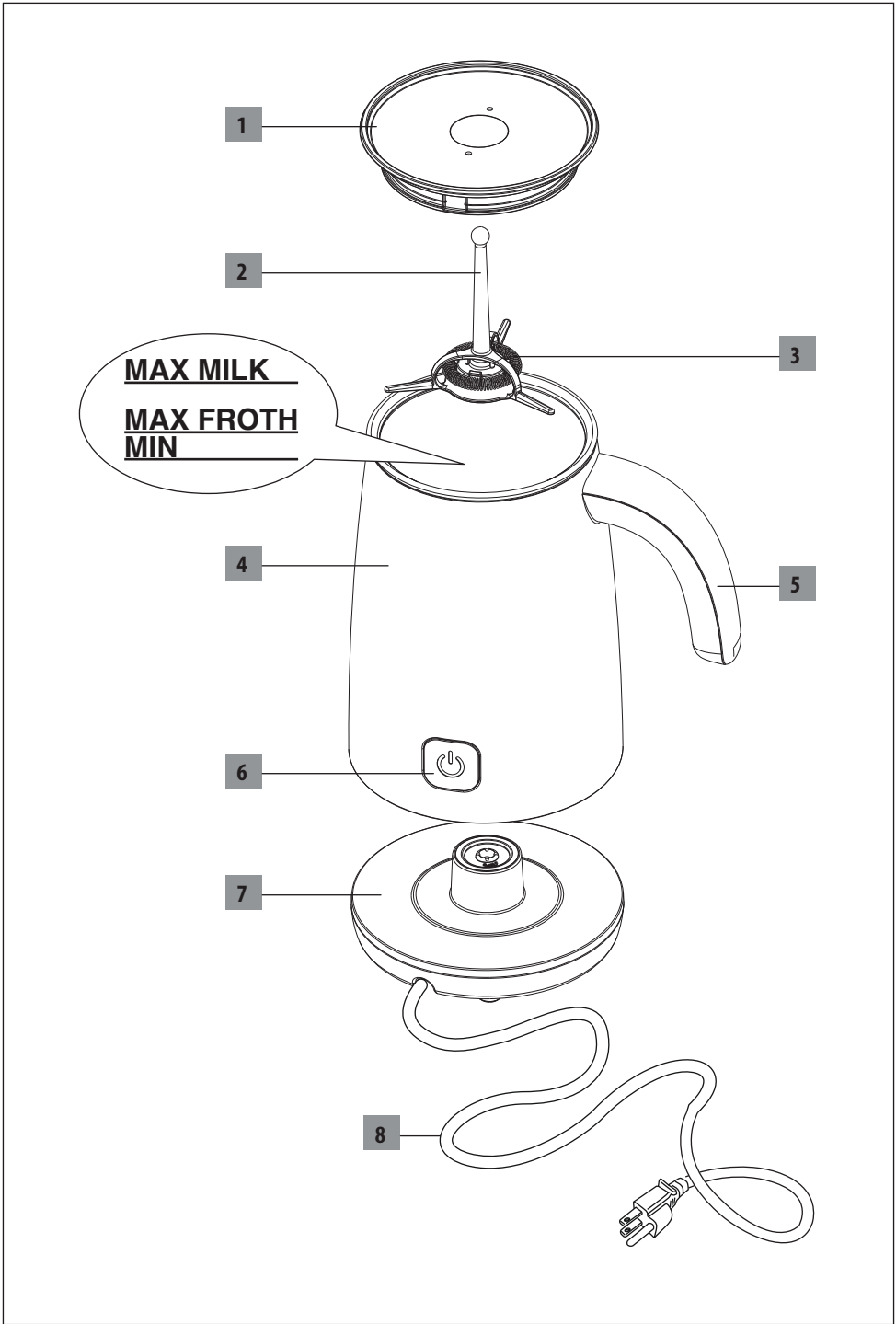

USE

Utilisation
Usò

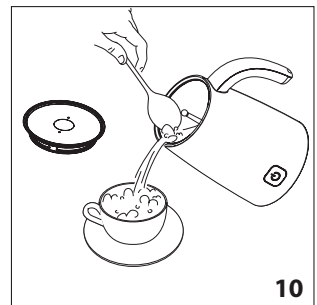
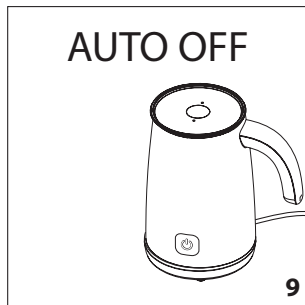
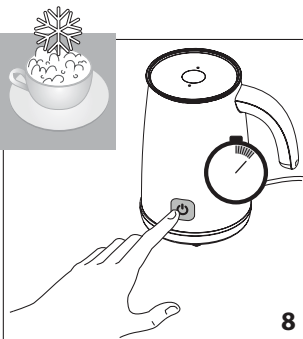
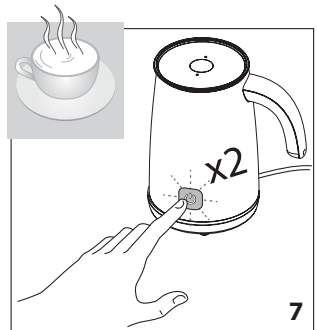
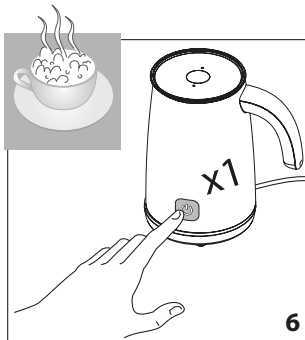
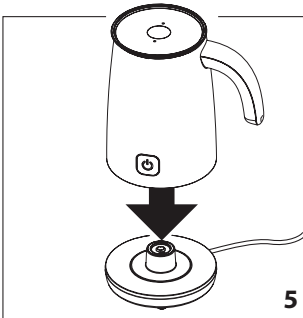
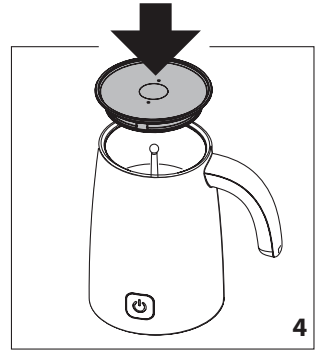
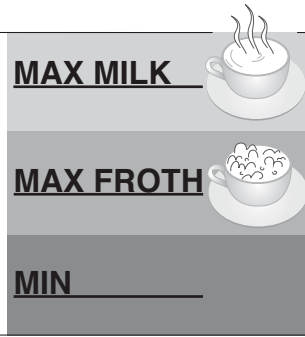
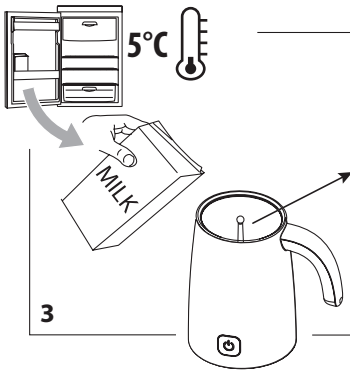
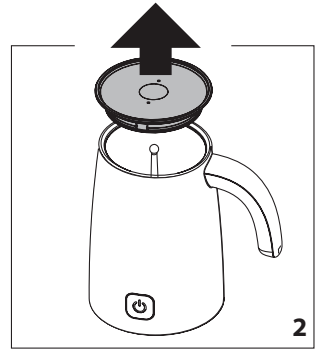
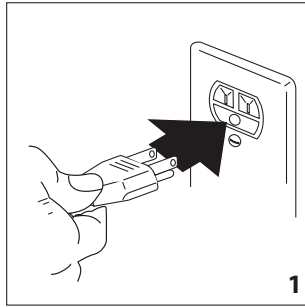

CLEANING

Nettoyage
Limpieza

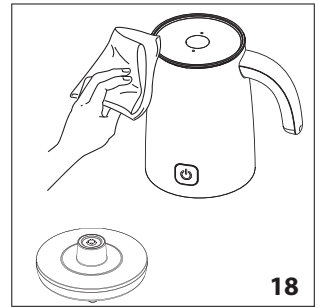
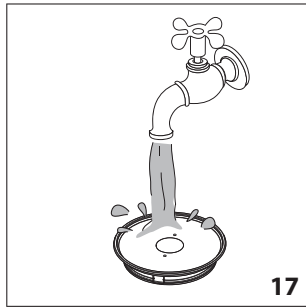
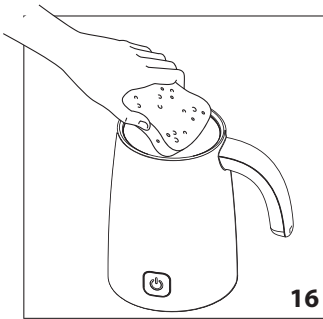
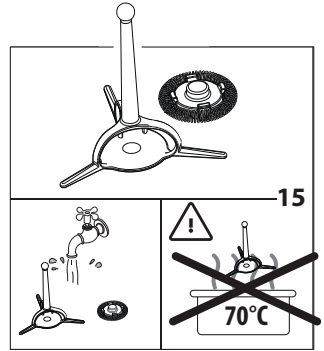
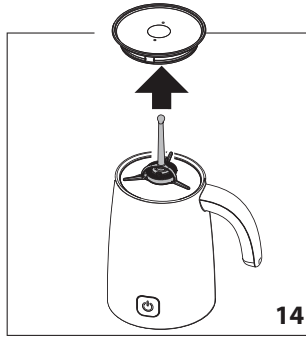
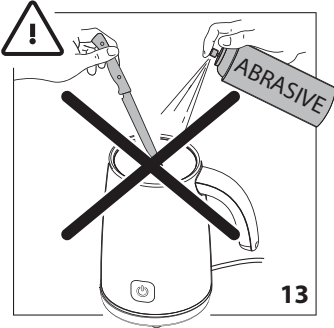
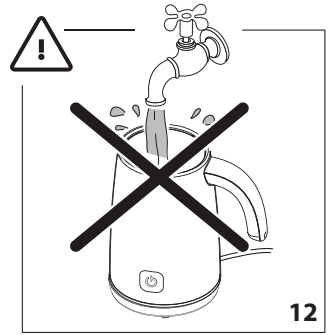
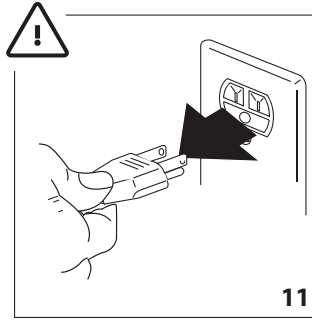

IMPORTANT SAFEGUARDS

When using electrical appliances, basic safety precautions should always be followed, including the following:

- Read all instructions carefully.
- Make sure the voltage of your electrical system corresponds to the voltage shown on the bottom of the machine.
- Do not touch hot surfaces. Use handles and knobs.
- Close supervision is necessary when the appliance is used by or near children.
- To protect against fire, electrical shock and personal injury, do not immerse cord, plug or appliance in water or other liquid.
- Keep the appliance out of the reach of children and do not leave appliance unattended while in operation.
- Unplug from the outlet when not in use and before cleaning. Allow to cool before fitting or taking off parts, and before cleaning the appliance.
- Do not operate with a damaged cord or plug, or after the appliance malfunctions, or has been damaged in any manner. Return the appliance to the nearest authorized service facility for examination, repair or adjustment.
- The use of accessory attachments or spare parts not recommended by the appliance manufacturer may result in fire, electrical shock or personal injury.
- Do not use outdoors.
- Make sure the power cord does not hang over the edge of the table or counter-top to avoid getting accidentally caught or entangled.
- Do not place the appliance or its electrical parts on or near electric stoves, cooking surfaces, or gas burners.
- Always attach plug to appliance first, then plug cord into the wall outlet. To disconnect, turn any control to "off," then remove plug from wall outlet.
- Do not use the appliance for other than the intended use. This appliance is to be utilized for domestic use only. The manufacturer declines all responsibility for any damage caused by improper, incorrect, or irresponsible use.

WARNING: To reduce the risk of fire or electric shock, do not remove the exterior of the unit or the cover. Don't attempt to repair or modify the machine, doing so will void the warranty. Repair should be done by authorized service personnel only!

SAVE THESE INSTRUCTIONS

THIS PRODUCT IS FOR HOUSEHOLD USE ONLY

SHORT CORD INSTRUCTIONS

- A short power cord is provided to reduce risks resulting from becoming entangled in or tripping over a longer cord.
- Longer, detachable power supply cords or extension cords are available and may be used if care is exercised in their use.
- If an extension cord is used, the marked electrical rating should be at least as great as the electrical rating of the appliance. If the appliance is provided with 3- wire, grounding type cord, the extension should be a GROUNDING TYPE 3 - WIRE CORD. The longer cord should be arranged so that it will not drape over the counter-top or table top where it can be pulled on by children or tripped over.

IMPORTANT SAFEGUARDS

Symbols used in these instructions

Important warnings are identified by these symbols. It is vital to respect these warnings.



Failure to observe the warning may result in life threatening injury by electric shock.



Failure to observe the warning could result in injury or damage to the appliance.



Failure to observe the warning could result in scalds or burns.



This symbol identifies important advice or information for the user.



This is an electrical appliance and may cause electric shock.

You should therefore follow these safety warnings:

- Never touch the appliance with damp hands or feet.
- Never touch the plug with damp hands.
- Make sure the socket used is freely accessible at all times, enabling the appliance to be unplugged when necessary.
- Unplug directly from the plug only.
Never pull the cord as you could damage it.
- To disconnect the appliance completely you must unplug it from the mains socket.
- If the appliance is faulty, do not attempt to repair.
Turn it off, unplug from the mains socket and contact Customer Services.
- Before cleaning the appliance, turn it off, unplug from the mains socket and allow to cool.



Keep all packaging (plastic bags, polystyrene foam) away from children.



When using the appliance do not touch the hot surfaces. Use the buttons or handles.

Instruction for Use

Read this Instruction for Use carefully before using the appliance.

Failure to follow this Instruction for Use may result in burns or damage to the appliance.

The manufacturer is not liable for damage deriving from failure to respect this Instruction for Use.



- Keep this Instruction for Use. If the appliance is passed to other persons, they must also be provided with this Instruction for Use.
- After removing the packaging, make sure the product is complete and undamaged and that all accessories are present.
- Do not use the appliance if it is visibly damaged. Contact Customer Services.
- Use the appliance on a flat surface.
- Do not exceed the recommended maximum quantities of milk, corresponding to 2 levels indicated inside the milk container (see fig. 3). Also respect the minimum level.
- Make sure the lid is tightly closed before operating the appliance.
- Always unplug the appliance after use, wait for it to cool down, then clean the milk container, lid and accessories thoroughly.



Never wash in a dishwasher.



- Never use solvents, abrasive detergents or alcohol to clean the appliance.

TECHNICAL DATA

Voltage:	120V~60Hz
Absorbed power:	500W
Size DxHxW:	118x199x168 mm
Cord length:	0,75 m
Weight:	0,84 kg

DESCRIPTION (page 3)

1. Lid
2. Hot/frothed milk accessory
3. Whisk
4. Milk container
5. Milk container handle
6. ON/OFF/function button:

Hot frothed milk	 red LED	Press once (fig. 6)
Hot milk (not frothed)	 flashing red LED	Press twice (fig. 7)
Cold frothed milk	 blue LED	press and hold for a few seconds (fig. 8)

7. Base with electrical connector
8. Power cord

Please note:

Preparation can be interrupted at any moment by simply lifting the milk container from the base or pressing the  button once.

TROUBLESHOOTING

Problem	Cause	Solution
The appliance does not come on	It is not plugged into the mains socket.	Plug into the mains.
	The appliance has a safety device which imposes a 30 second pause between one preparation and the next.	Wait, then select the required function.
There is little or no froth on the milk	The "Hot milk (not frothed)" function is selected.	Prepare the milk again, using milk at refrigerator temperature and pressing the function button once (red LED on steadily).
	The milk is too hot.	Use milk at refrigerator temperature.
	After cleaning, the whisk (3) has not been replaced in the hot/frothed milk accessory, or the whole accessory is absent or incorrectly positioned.	Insert the whisk in the accessory and make sure the accessory is correctly positioned in the appliance.
The milk overflows.	Too much milk has been placed in the container.	Always respect the MAX quantity indicated for each preparation.
	The appliance is standing on a sloping surface.	The appliance must always be operated on a flat surface.
The blue LED flashes 	The appliance has been operated without milk.	Remove the appliance from the base. Wait until it cools down. To cool it down faster, pour milk at refrigerator temperature into the container.

LIMITED WARRANTY

This warranty applies to all products with De'Longhi or Kenwood brand names.

What does the warranty cover?

We warrant each appliance to be free from defects in material and workmanship. Our obligation under this warranty is limited to repair at our factory or authorized service center of any defective parts or part thereof, other than parts damaged in transit. In the event of a products replacement or return, the unit must be returned transportation prepaid. The repaired or replacement model will be returned at the company expense.

This warranty shall apply only if the appliance is used in accordance with the factory directions, which accompany it, and on an Alternating current (AC) circuit.

How long does the coverage last?

This warranty runs for one year (1) from the purchase date found on your receipt and applies only to the original purchaser for use.

What is not covered by the warranty?

The warranty does not cover defects or damage of the appliance, which result from repairs or alterations to the appliance outside our factory or authorized service centers, nor shall it apply to any appliance, which has been subject to abuse, misuse, negligence or accidents. Also, consequential and incidental damage resulting from the use of this product or arising out of any breach of contract or breach of this warranty are not recoverable under this warranty. Some states do not allow the exclusion or limitation of incidental or consequential damage, so the above limitation may not apply to you.

How do you get service?

If repairs become necessary, see contact information below:

U.S. Residents:

Please contact our toll free hotline at 01-800-322-3848 or log onto our website at www.delonghi.com.

Residents of Canada:

Please contact our toll free hotline at 01-888-335-6644 or log onto our website at www.delonghi.com.

Residents of Mexico:

Please contact our toll free hotline at 01-800-711-8805 or log onto our website at www.delonghi.com.

The above warranty is in lieu of all other express warranties and representations. All implied warranties are limited to the applicable warranty period set forth above. This limitation does not apply if you enter into an extended warranty with De'Longhi. Some states/countries do not allow limitations on how long an implied warranty lasts, so the above exclusions may not apply to you. De'Longhi does not authorize any other person or company to assume for it any liability in connection with the sale or use of its appliance.

How does state law apply?

This warranty gives you specific legal rights, and you may also have other rights, which vary from state to state/country to country.