



奶 泡 机
MILK FROTHER

使
用
说
明
书

目 录

安全警告	4
机器的废旧处理	5
产品的描述	5
常见问题的处理	6

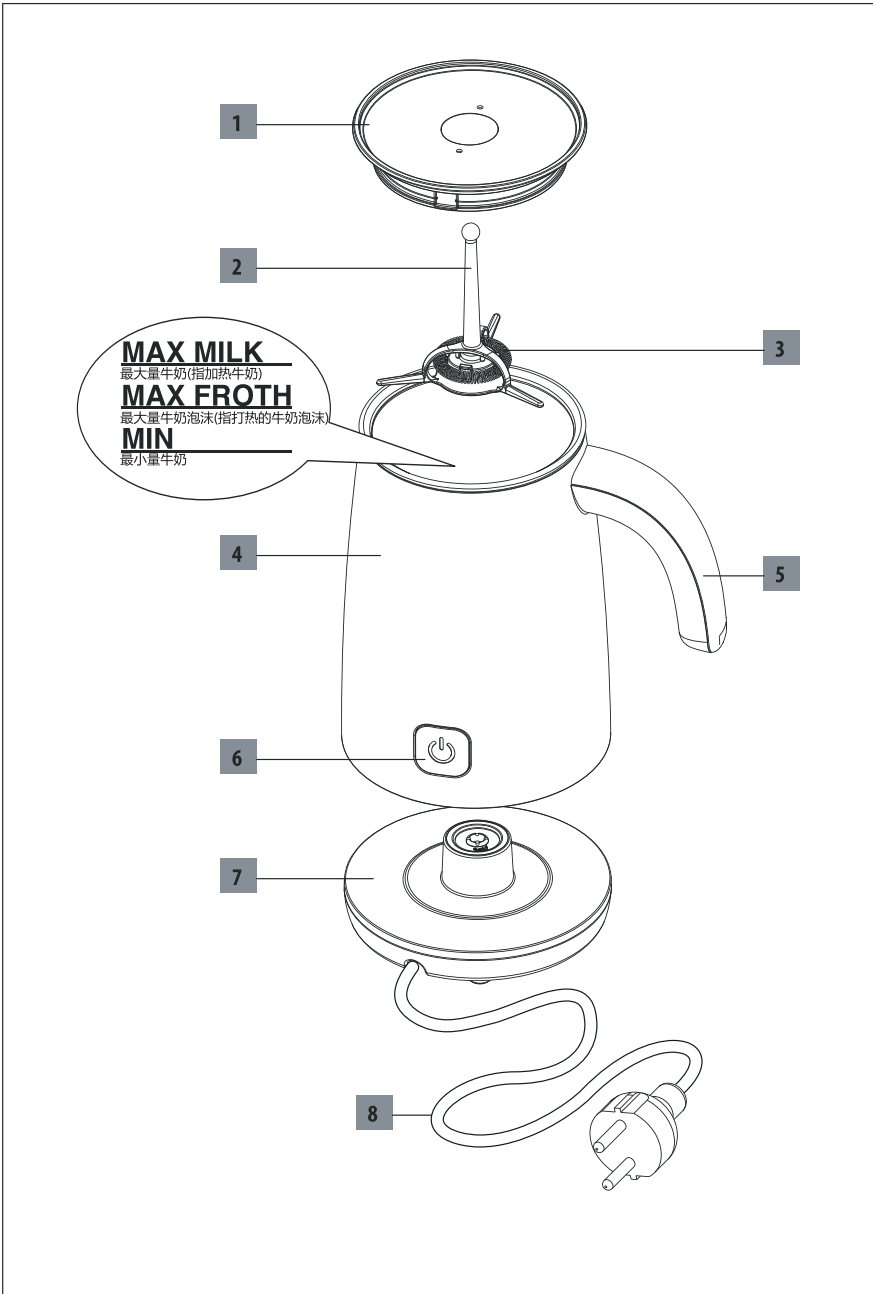

使用图示

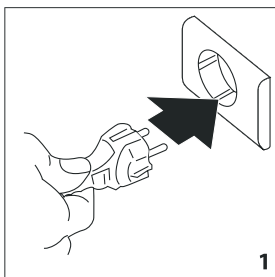

接通电源

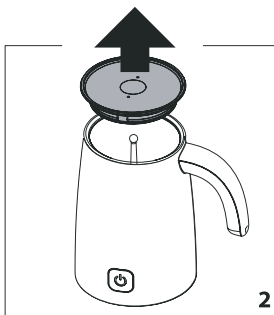

往上提取下牛奶容器盖

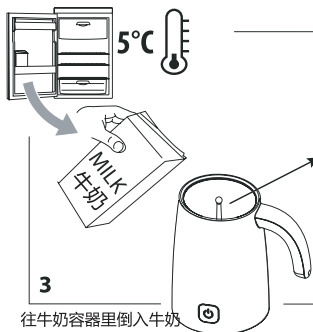

往牛奶容器里倒入牛奶

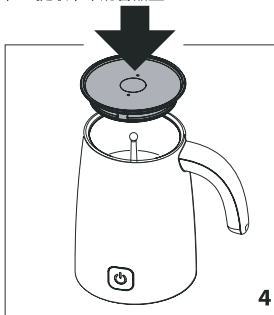

盖上牛奶容器盖

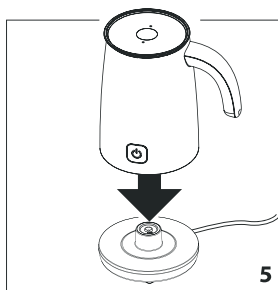

将牛奶容器放回到机器上

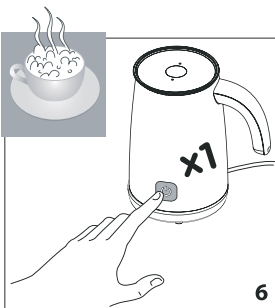

按一下此按钮，制作热牛奶泡沫

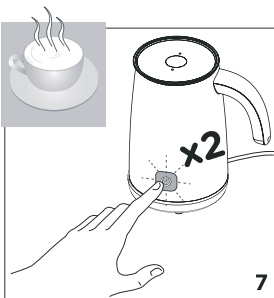

连续按两下此按钮，加热牛奶

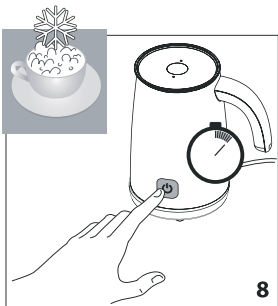

长按此按钮，制作冷的牛奶泡沫

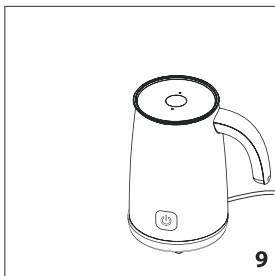

自动关闭

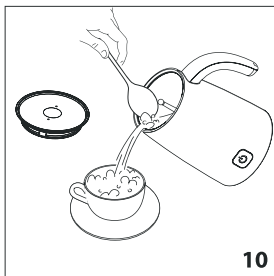

将制作好的牛奶倒入咖啡中

清洁图示

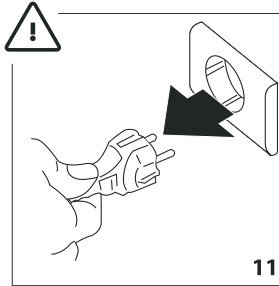

拔下电源插头

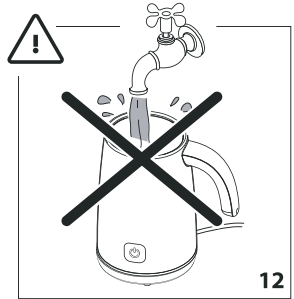

切勿用流动地水冲洗整个机器

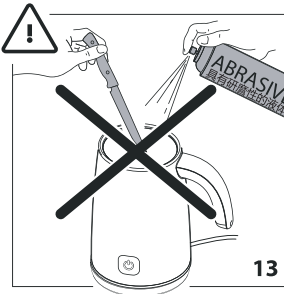

切勿用具有研磨性的清洗剂进行清洁

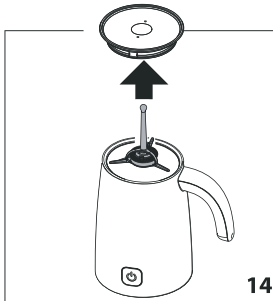

往上提取下盖牛奶容器盖，然后取出搅拌机

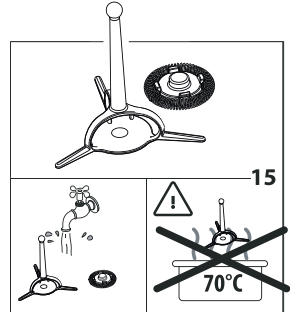

用流动地水冲洗搅拌器的各个配件。切勿用超过70°C的水清洗搅拌机。

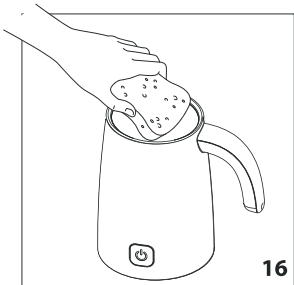

用一块海绵清洗搅拌器的内部

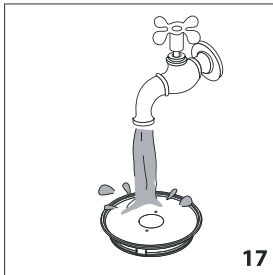

用流动的水冲牛奶容器盖

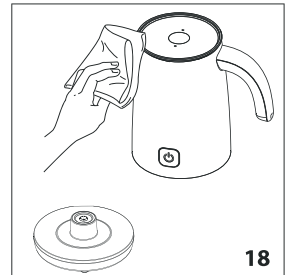

用一块抹布清洁机器的外部

安全警告

- 有心理、身体或者感官障碍、或不具备足够的经验或者知识的人员（包括儿童）不允许使用该电器，除非有对他们的安全负责的人密切监督并进行指导。
- 确保儿童不玩弄该电器。
- 切勿在无人看管的情况下让孩童进行清洁和保养机器。
- 清洁时，切勿将机器浸入水中。
- 这只是一台家用电器，并不适用于以下场所：商场的员工餐厅，办公室或其他工作环境；牧场旅馆；旅馆、汽车旅馆或其他住宅性环境的住客；家庭式旅馆。
- 如果机器的插头和电源线损坏，必须由德龙指定的售后服务人员进行更换，以避免各种危险。
- 避免液体溢出，接触到机器的连接器。
- 任何的误操作会导致潜在的伤害。
- 使用完后，加热管的表面会持续发热。
- 加入的牛奶量不能超过牛奶容器内部标注的MAX(最多)线。如果超过这个MAX线，热牛奶会从盖子的边缘溢出来，且会烫伤。
- 只能与配备的底座搭配使用。



重要的安全警告

说明书中使用的符号

说明书中重要的警告都用这些符号表示，必须遵守这些警告。



危险！

不遵守这些安全警告，有可能导致触电的人身伤害。



重要！

不遵守这些安全警告，有可能导致人身伤害或损坏机器。



烫伤危险！

不遵守这些安全警告，有可能导致烫伤或烧伤。



请注意：

这些重要的建议或信息对使用者来说十分的重要。



危险！

这是一台电器设备，因此可能导致触电。因此您应该遵守以下安全警告：

- 切勿用湿的手或湿的脚接触该机器。
- 切勿用湿的手接触插头。
- 确保能随时接近机器使用的插座，必要时能拔下机器的插头。
- 直接拔下电源插头，切勿拉扯电源线，以免损坏电源线。
- 要完全断开机器的电源，请拔下电源线插头。
- 如果机器发生故障，不要试图自己检修。关闭电源，拔下插头，并与售后服务中心联系。
- 在对机器进行清洁之前，请先关闭电源，拔下插头，并等待机器冷却。



重要：

各种包装（塑料袋、聚苯乙烯泡沫塑料）必须远离儿童存放。



烫伤危险！

机器使用时切勿接触热的表面，请直接接触按钮或手柄。

使用说明

在使用此机器之前，请先仔细地阅读此说明书。不遵守这些说明，有可能会致人身伤害或损坏机器。

制造商对于未安说明正确操作导致的机器损坏，不负任何责任。



请注意：

- 请保存好此说明书。如果机器转赠他人，请连同说明书一起转赠。
- 打开包装后，确认机器表面完好且没有被损坏，同时所有的配件齐全。
- 如果机器有明显的损坏，切勿使用该机器。请与德龙授权的售后服务中心联系。
- 请在一个平整的表面上使用此机器。
- 倒入的牛奶量切勿超过牛奶容器内部标注的位置（详见图3）。同时也请注意倒入牛奶量最小量的标注位置。
- 在启动机器前，请确保牛奶容器盖已盖紧。

- 每次使用完后，请拔下电源插头，并待其冷却。然后再彻底地清洁牛奶容器，牛奶容器盖和配件。



切勿用洗碗机进行清洗。

- 切勿使用具有溶解性、研磨性的物体或酒精进行清洁机器。







机器的废旧处理

根据欧盟EC2002/96号的指令，本机器不能作为一般的家用垃圾进行处理，必须交于授权的专业回收机构进行处理。



产品的描述

- 1、牛奶容器盖
- 2、热牛奶/牛奶泡沫附件
- 3、搅拌器
- 4、牛奶容器
- 5、牛奶容器把手
- 6、开启/关闭按钮：

热的牛奶泡沫	 红色指示灯常亮	按一次  (如图6)
热牛奶 (不打奶泡)	 红色指示灯闪烁	按两次  (如图7)
冷的牛奶泡沫	 蓝色指示灯常亮	持续按  几秒钟(如图8)

- 7、底座
- 8、电源线



请注意：

将牛奶容器从底座上拿起或按一下  按钮，可以随时停止机器的运作。

常见问题的处理

出现的问题	造成的原因	解决的方法
机器无法开启	机器未接通电源	接通机器的电源
	机器启动了安全装置，两次制作的间隔至少30秒	等待，然后选择所需的功能
牛奶泡沫很少或打不出牛奶泡沫	选择了制作热牛奶（不是打牛奶泡沫）的功能	重新准备牛奶，使用冰箱冷藏的牛奶，然后再按一次功能按钮（红色指示灯持续亮起）
	牛奶太烫了	使用冰箱冷藏的牛奶
	清洁后，搅拌器未装回热牛奶/牛奶泡沫附件中，或者热牛奶/牛奶泡沫附件未安装，或者安装位置不正确	在热牛奶/牛奶泡沫附件中装入搅拌器，且确保热牛奶/牛奶泡沫附件安装在正确的位置
牛奶溢出来	牛奶容器中倒入了太多的牛奶	每次倒入的牛奶量不能超过牛奶容器内部标的最多量(如图3)
	机器放置在一个倾斜的表面上	机器使用时必须放置在一个平整的表面上
蓝色LED指示灯闪烁 	在未倒入牛奶的情况下使用机器	从底座上取下牛奶容器，将待其冷却。如需快速冷却，请在牛奶容器中倒入冰箱冷藏的牛奶。

FUNDAMENTAL SAFETY WARNINGS

- The appliance is not intended for use by persons (including children) with reduced physical, sensory or mental capabilities, or lack of experience and knowledge, unless they have been given supervision or instruction concerning use of the appliance by a person responsible for their safety.
- Children should be supervised to ensure that they do not play with the appliance.
- Cleaning and user maintenance shall not be made by children without supervision.
- Never clean by immersing the appliance in water.
- This is an household appliance only. It is not intended to be used in: staff kitchen areas in shops, offices and other working environments; farm houses; by clients in hotels, motels and other residential type environments; bed and breakfast type environments.
- If the plug or power cable is damaged, it must be replaced by customer services only to avoid all risk.
- Only to be used with the stand provided.

FOR EUROPEAN MARKETS ONLY:

- This appliance can be used by children aged from 8 years and above if they have been given supervision or instruction concerning use of the appliance in a safe way and if they understand the hazard involved. Cleaning and user maintenance shall not be made by children unless they are older than 8 and supervised.
Keep the appliance and its cord out of the reach of children aged less than 8 years.
- Appliances can be used by persons with reduced physical, sensory or mental capabilities or lack of experience and knowledge if they have been given supervision or instruction concerning use of the appliance in a safe way and if they understand the hazards involved.
- Children shall not play with the appliance.
- When not in use and before putting on or taking off parts or cleaning, always unplug the appliance.



Surfaces marked with this symbol become hot during use (the symbol is present in certain models only).

IMPORTANT SAFEGUARDS

Symbols used in these instructions

Important warnings are identified by these symbols. It is vital to respect these warnings.



Danger!

Failure to observe the warning may result in life threatening injury by electric shock.



Important!

Failure to observe the warning could result in injury or damage to the appliance.



Danger of burns!

Failure to observe the warning could result in scalds or burns.



Please note:

This symbol identifies important advice or information for the user.



Danger!

This is an electrical appliance and may cause electric shock.

You should therefore follow these safety warnings:

- Never touch the appliance with damp hands or feet.
- Never touch the plug with damp hands.
- Avoid spilling liquid on the connector.
- Do not place on or near a hot gas or electric burner, or in a heated oven.
- Make sure the socket used is freely accessible at all times, enabling the appliance to be unplugged when necessary.
- Unplug directly from the plug only.
Never pull the cord as you could damage it.
- Do not let cord hang over edge of table or counter, or touch hot surfaces.
- To disconnect the appliance completely you must unplug it from the mains socket.
- If the appliance is faulty, do not attempt to repair.
Turn it off, unplug from the mains socket and contact Customer Services.
- Before cleaning the appliance, turn it off, unplug from the mains socket and allow to cool (fig. 11).
- During cleaning, never immerse the base and boiler in water. This is an electrical appliance (fig. 19).



Important:

- After removing the packaging, make sure the product is complete and undamaged and that all accessories are present.
- Keep all packaging (plastic bags, polystyrene foam) away from children.
- All inappropriate uses may cause injury.
- Use the appliance on a flat surface.

- Do not use the appliance if it is visibly damaged. Contact Customer Services.
- Make sure the lid is tightly closed before operating the appliance.



Danger of burns!

- When using the appliance do not touch the hot surfaces. Use the buttons or handles.
- The surface of the heating element remains hot after use.
- Never exceed the maximum level indicated in the appliance (fig. 3). If this level is exceeded, hot milk may leak from the lid and result in scald.

Instruction for Use

Read this Instruction for Use carefully before using the appliance.

Failure to follow this Instruction for Use may result in burns or damage to the appliance.

The manufacturer is not liable for damage deriving from failure to respect this Instruction for Use.





Please note:

- Keep this Instruction for Use. If the appliance is passed to other persons, they must also be provided with this Instruction for Use.

DESCRIPTION (page 3)

- A. Lid
- B. Hot/frothed milk accessory
- C. Whisk
- D. Milk container
- E. Milk container handle
- F. ON/OFF/function button
- G. Base with electrical connector
- H. Power cord

PREPARING MILK

Hot frothed milk	 red LED	Press once (fig. 6)
Hot milk (not frothed)	 flashing red LED	Press twice (fig. 7)
Cold frothed milk	 blue LED	press and hold for a few seconds (fig. 8)

TIPS FOR USE AND CLEANING

The first time the appliance is used, all the accessories and internal components should be washed with water. Then make a few preparations using water instead of milk.

Please note:

Preparation can be interrupted at any moment by simply lifting the milk container from the base or pressing the  button once.



Never wash in a dishwasher.

- Never use solvents, abrasive detergents or alcohol to clean the appliance (fig. 13).

Materials and accessories coming into contact with food conform to EEC regulation 1935/2004.

DISPOSAL



The appliance must not be disposed of with household waste, but taken to an authorised waste separation and recycling centre.

TROUBLESHOOTING

Problem	Cause	Solution
The appliance does not come on	It is not plugged into the mains socket.	Plug into the mains.
	The appliance has a safety device which imposes a 30 second pause between one preparation and the next.	Wait, then select the required function.
There is little or no froth on the milk	The "Hot milk (not frothed)" function is selected.	Prepare the milk again, using milk at refrigerator temperature and pressing the function button once (red LED on steadily).
	The milk is too hot.	Use milk at refrigerator temperature.
	After cleaning, the whisk (C) has not been replaced in the hot/frothed milk accessory, or the whole accessory is absent or incorrectly positioned.	Insert the whisk in the accessory and make sure the accessory is correctly positioned in the appliance.
The milk overflows.	Too much milk has been placed in the container.	Always respect the MAX quantity indicated for each preparation.
	The appliance is standing on a sloping surface.	The appliance must always be operated on a flat surface.
The blue LED flashes 	The appliance has been operated without milk.	Remove the appliance from the base. Wait until it cools down. To cool it down faster, pour milk at refrigerator temperature into the container.



★若有任何需求请与下述地址联系：

☆ 邑隆贸易(上海)有限公司

地址：上海市中山北路3553号伸大厦2001-2016室

电话：(021) 3135 8858 传真：(021) 3135 8262 邮编：200062

客户热线：400 827 1668

网址：www.delonghi.com.cn