



VERTUO POP+



NESPRESSO

CLICK AND CHOOSE YOUR LANGUAGE
CLIQUEZ ET CHOISISSEZ VOTRE LANGUE

EN

FR

ES

CLICK AND CHOOSE YOUR LANGUAGE

EN



SAFETY



OVERVIEW



CONNECTIVITY



FIRST STEPS



COFFEE PREPARATION



ADAPT YOUR COFFEE VOLUME



CLEANING



DESCALING



EMPTYING THE SYSTEM



RESET TO FACTORY SETTINGS



BLINKING SUMMARY



TROUBLESHOOTING



SPECIFICATIONS

SAFETY

CAUTION: Before operating your coffee machine, please refer to the [safety instructions leaflet](#) to avoid possible harm and damage.

DISPOSAL AND ENVIRONMENTAL PROTECTION

This appliance complies with the EU Directive 2012/19/EC. Packaging materials and appliance contain recyclable materials. Your appliance contains valuable materials that can be recovered or can be recycled. Separation of the remaining waste materials into different types facilitates the recycling of valuable raw materials. Leave the appliance at a collection point. You can obtain information on disposal from your local authorities.



OVERVIEW

MACHINE OVERVIEW

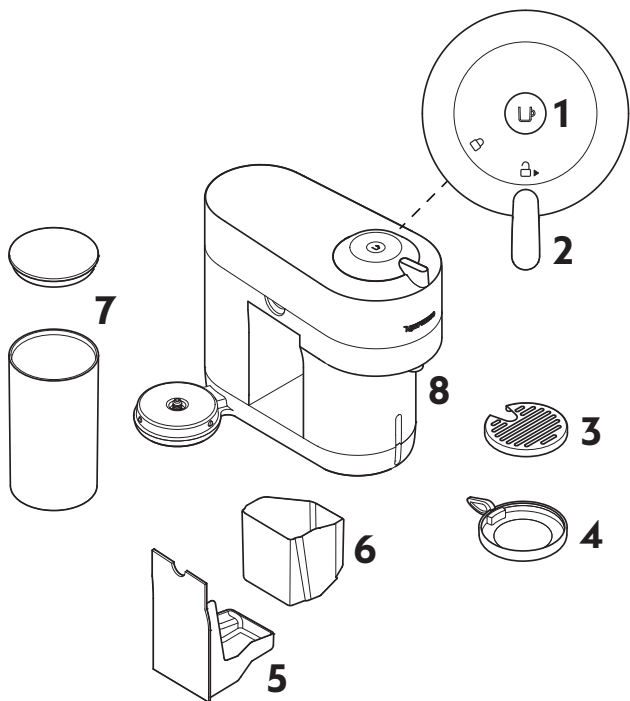

- 1 ON/OFF and coffee button
- 2 Locking/Unlocking lever
- 3 Drip Grid
- 4 Adjustable cup support
- 5 Drip Tray
- 6 Container for used capsules
- 7 Water Tank and lid
- 8 Coffee outlet

PACKAGING CONTENT



- 1 Coffee Machine
- 2 **Nespresso** capsules box
- 3 **Nespresso** welcome material
- 4 Safety Instructions
- 5 Quick Start Guide
- 6 Warranty

4 + 5 + 6

i Unboxing: some dust may be present on the surface of the machine due to the recycled materials used in the packaging. This is not dangerous, simply clean with a soft tissue.

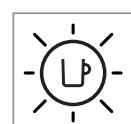
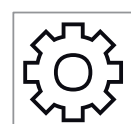
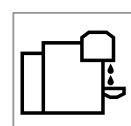
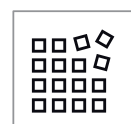
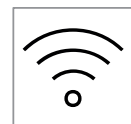



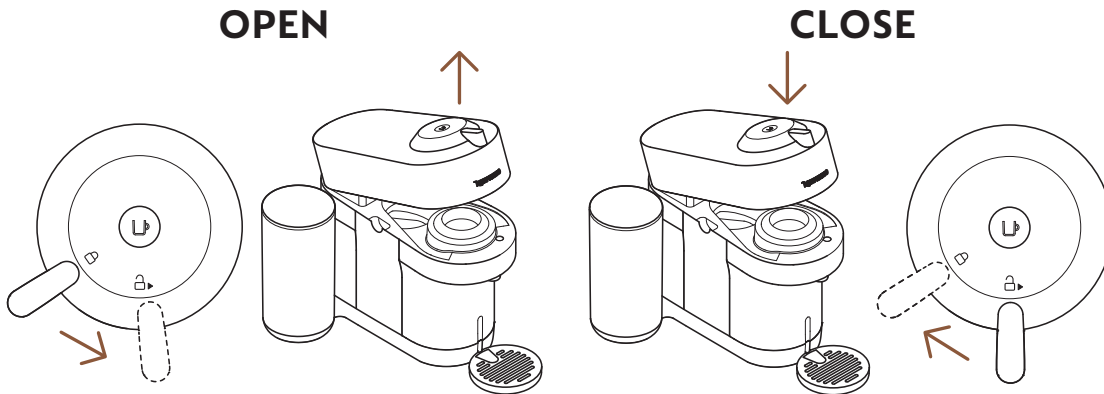

OPEN/CLOSE



CAUTION: for proper machine usage, please do not open the machine head while the coffee is brewing, wait until the coffee button goes back to steady white. If you want to stop the brewing earlier, please press once on the coffee button and wait until the machine stops before opening the machine head.

THE VERTUO SYSTEM

CAPSULE COMPATIBILITY

			
S	M	L	XL
Ristretto (25 ml / 0.84 fl oz.)	Double Espresso (80 ml / 2.7 fl oz.)	Mug (230 ml / 7.77 fl oz.)	Alto, Cold Brew Style (355 ml / 12.5 fl oz.)
Espresso (40 ml / 1.35 fl oz.)	Gran Lungo (150 ml / 5.07 fl oz.)		Carafe (535 ml / 18 fl oz.)

ACCESSORY COMPATIBILITY



Accessory compatibility

Ristretto **Espresso** **Double Espresso** **Gran Lungo** **Mug (S)** **Mug (M)** **Reveal Glass**



Not suitable accessories



Mug (L) **Carafe**

Discover our full accessory collection on www.nespresso.com

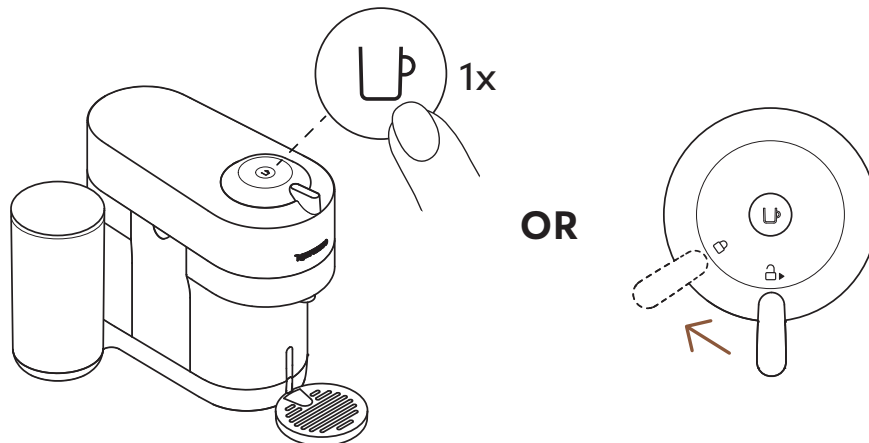

ON/OFF

**ON**

Once the machine is plugged in, turn on by pressing once on the button or by closing the lever in the lock position (with the head closed).

- i** The light will blink for approximately 30 seconds while the machine is heating up. Once the light is steady, the machine is ready to be used.

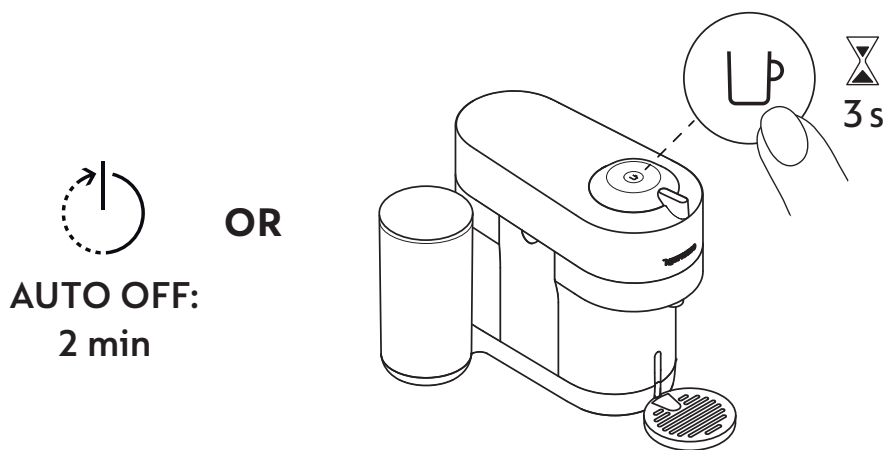
**OFF**

To save energy the machine will turn off after 2 minutes of non-use.

- i** The machine can be turned "OFF" manually at any time (when not in use) by pressing and holding the button for 3 seconds.

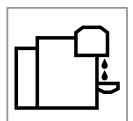
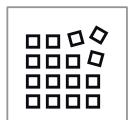

CONNECTIVITY

WHY SHOULD YOU PAIR YOUR VERTUO POP+ MACHINE?

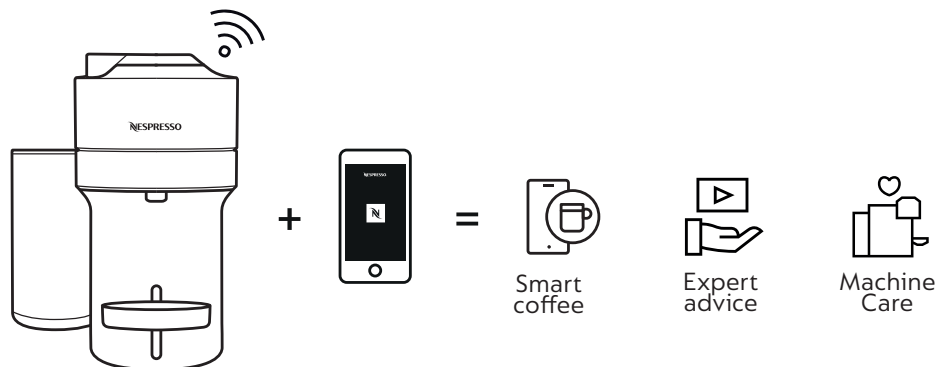

BENEFITS OF CONNECTING YOUR VERTUO POP+ MACHINE

- **Smart coffee:** Always stay one step ahead to get the latest on our coffee innovations from **Nespresso** by keeping your machine up to date
- **Expert advice:** Get support and simple tutorial videos to accompany your coffee journey via your smartphone
- **Machine Care:** Receive instant notification on how and when to service your machine with an easy-step guide on descaling, rinsing, cleaning, etc.

HOW TO CONNECT YOUR VERTUO POP+ MACHINE?

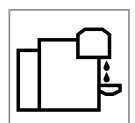
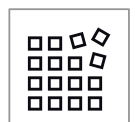

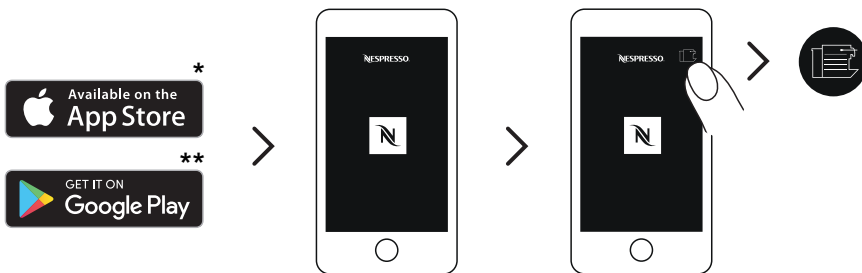

1 Download or update the **Nespresso** App. Launch the **Nespresso** App on your smartphone or your tablet. Press the machine icon at the top right of your screen.

NOTE: for optimal performance and a seamless experience, we recommend connecting your machine to a Wi-Fi router rather than using a smartphone hotspot.

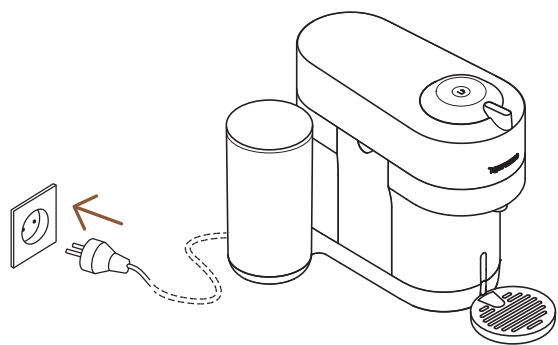

2 Plug the power chord.

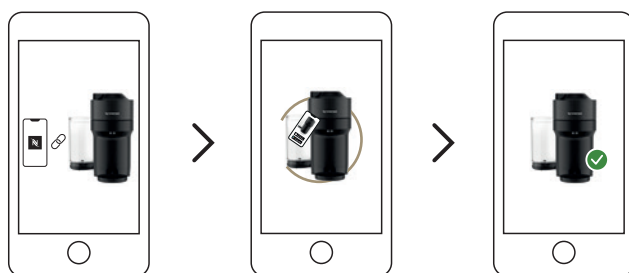

3 Follow the instructions via the **Nespresso** App.

CAUTION: First read the safety precautions to avoid risks of fatal electrical shock and fire. Please ensure ground continuity when plugging the machine in the power outlet.

* App Store® is a trademark of Apple Inc., registered in the U.S. and other countries.
 ** Google Play and the Google Play logo are trademarks of Google LLC.



DISABLING MACHINE BLUETOOTH AND WI-FI

The machine comes with a connectivity module, enabled by default. It gives access to additional features, enhancing your coffee experience. To disable the connectivity module, follow these steps:

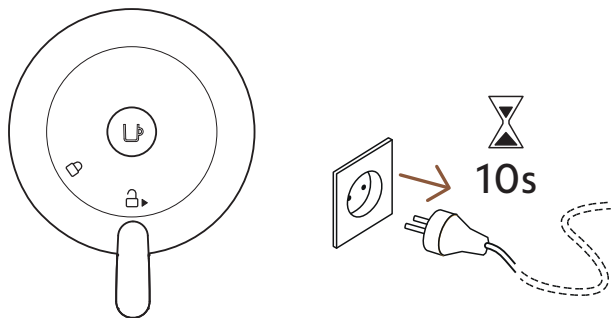

- 1 With the machine closed and the lever in **unlocked** position, unplug the machine for at least 10 seconds.

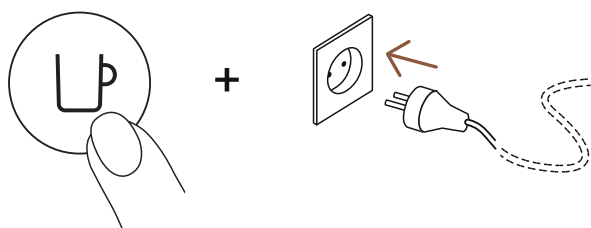

- 2 Press and hold the button while plugging. The button will blink orange to confirm that the connectivity module has now been disabled.

- i** Follow the same steps to set the connectivity module back on again. The button will blink white to confirm that the module has been reactivated.

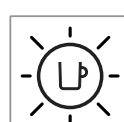
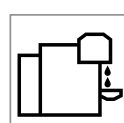
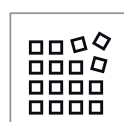
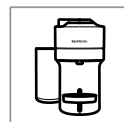

FIRST STEPS

FIRST RINSING

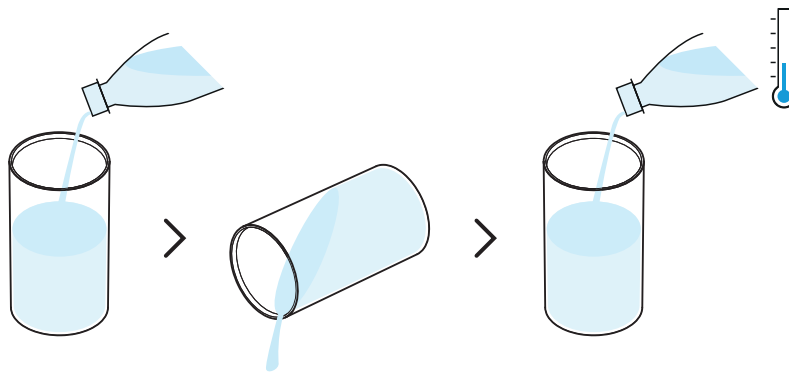

- 1** First rinse and clean the water tank and lid before filling it with fresh drinking water.

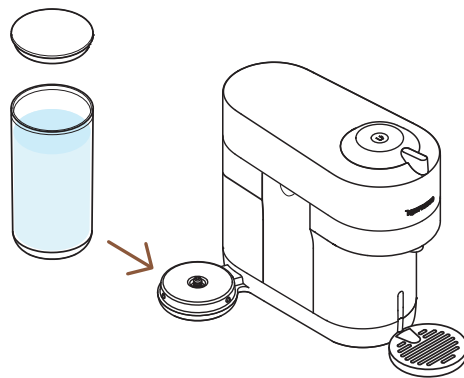

- 2** Close the water tank with the lid and put the water tank in place and make sure it is properly attached.



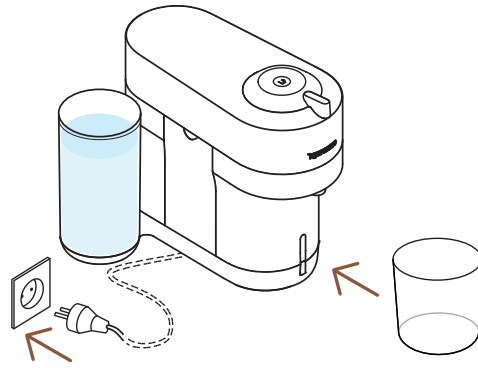

- 3** With the machine plugged, remove the cup support and place an empty container (of at least 1 L / 34 fl oz.) under the coffee outlet.

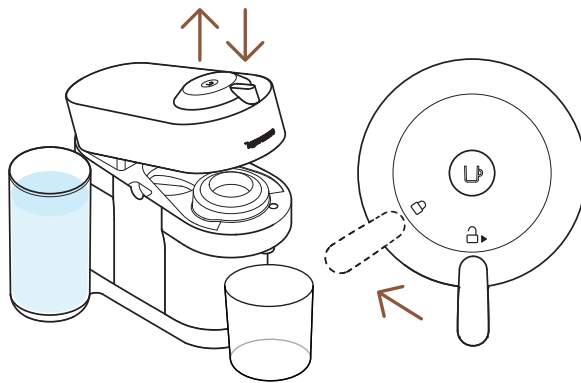

- 4** Open and close the machine. Ensure the lever is in lock position.

- i** The light will blink while the machine is heating up. It will take approximately 30 seconds. When the light becomes steady the machine is ready. Make sure that no capsule is inserted.

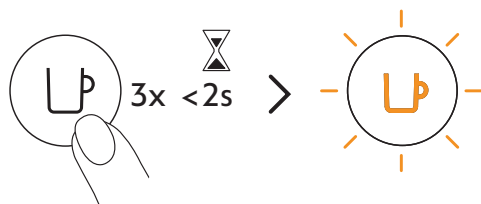

- 5** Press the button 3 times within 2 seconds to start rinsing. With the light blinking orange, let the rinsing procedure complete automatically. When the light becomes steady white, the cycle is complete.

- i** It should take less than 2 minutes before the rinsing process begins and water starts to flow. This procedure may take up to 7 minutes.

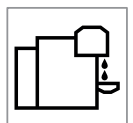

COFFEE PREPARATION



1 Open and close the machine.

i The coffee button light will blink while the machine is heating up. When the light becomes steady, the machine is ready to use.

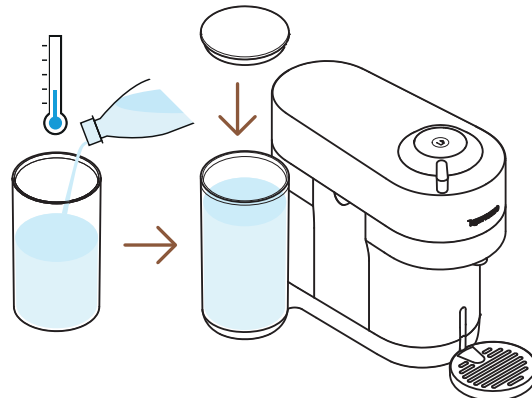

2 Fill the water tank with fresh drinking water and put it back in position.

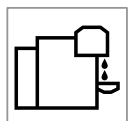
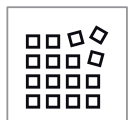

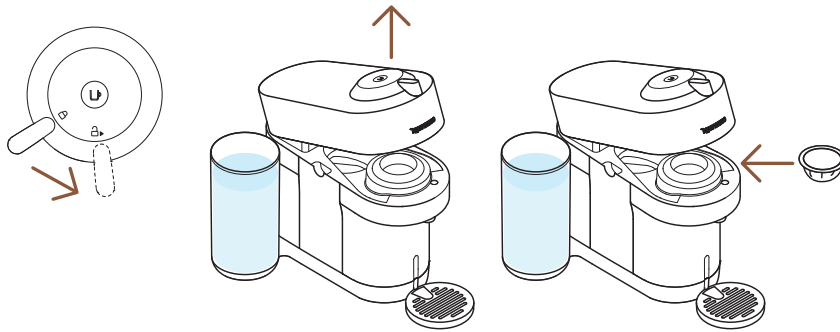

- 3** Unlock and open the machine head completely and insert a Vertuo capsule with the dome shape facing down.

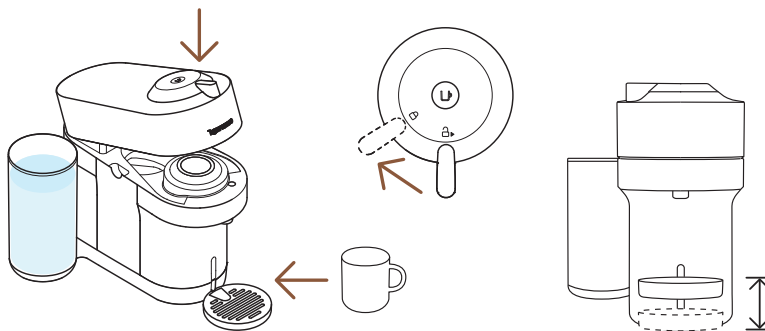

- 4** Close the machine head and lock by turning the lever left until the lock position and place a cup. The cup support can be adjusted to accommodate your cup size.

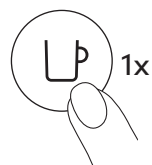

- 5** Start brewing by pressing the button once.

CAUTION: for proper machine usage, please do not open the machine head while the coffee is brewing, wait until the coffee button goes back to steady white. If you want to stop the brewing earlier, please press once on the coffee button and wait until the machine stops before opening the machine head.

- i** Due to the code reading, coffee pre-wetting and infusion time, it will take a moment before the coffee begins to flow. The machine will automatically recognize the inserted capsule and select the coffee preparation parameters and cup length defined by **Nespresso** coffee experts to extract the coffee blends at it's best.

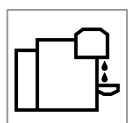

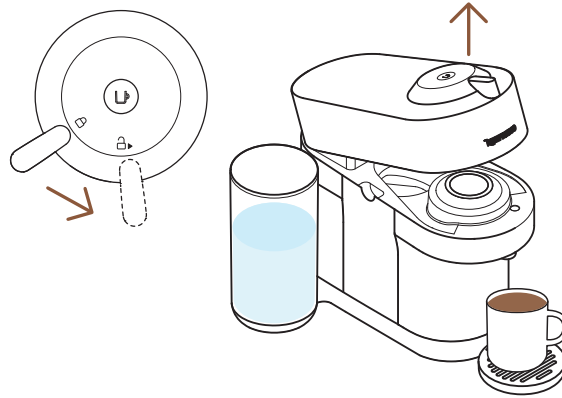

- 6** When the coffee stops brewing, open the machine head by turning the lever right towards the unlock position to automatically eject the capsule and enjoy your coffee.



- 7** Don't forget to recycle your **Nespresso** capsules.*

* THIS IS **NESPRESSO**. THIS IS RECYCLABLE. For more information about recycling your **Nespresso** capsules, visit www.nespresso.com

DISCOVER OUR COFFEE CREATIONS MODE



With this machine, **Nespresso** offers you a specific function to concentrate your coffee extractions to create your own recipes.

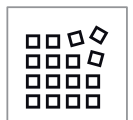

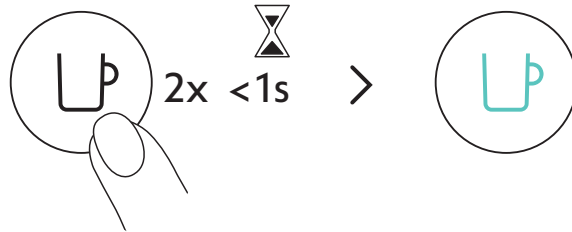

With your machine on, double click on the coffee button. It will blink turquoise and your coffee brew will be concentrated, optimizing the coffee taste in recipes with add-ons (milk, creamer, over ice...). For Incomparable Coffee Experience.

40 ml / 1.35 fl oz	80 ml / 2.7 fl oz	150 ml / 5.07 fl oz	230 ml / 7.77 fl oz	355 ml / 12 fl oz	535 ml / 18.8 fl oz
✓	✓	✓	✓	✗	✗
25 ml / 0.85 fl oz	40 ml / 1.35 fl oz	40 ml / 1.35 fl oz	80 ml / 2.7 fl oz		

To fully enjoy the benefits, we recommend brewing our Coffee+ range using only the official cup sizes. For the best in-cup results, we do not recommend brewing our XL (Alto Ambrato, Alto Onice), Cold Brew Style & Carafe Pour Over Style with this mode.

NOTE: An update of your machine via the **Nespresso** App may be necessary to enable this mode.



Discover how to upgrade your machine with our Aeroccino range on www.nespresso.com

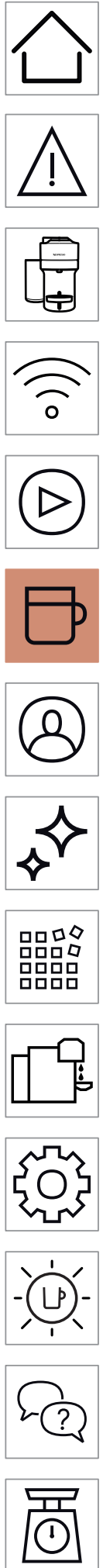

ADAPT YOUR COFFEE VOLUMES

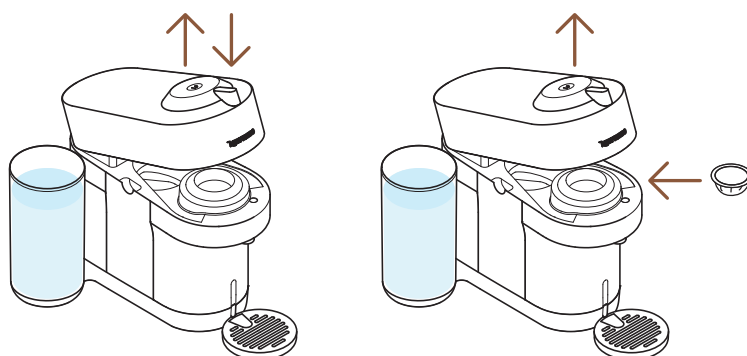

- 1** With the machine on, open the machine and insert the capsule you want to program.

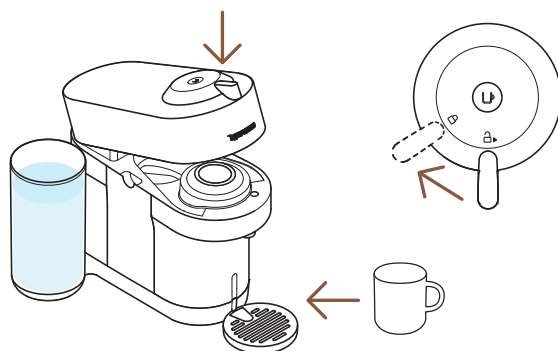

- 2** Close the machine head, turn the lever left towards the lock position and place a cup.

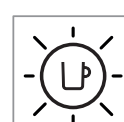
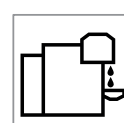
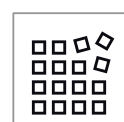
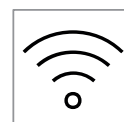
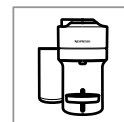

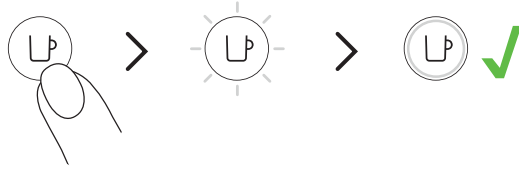

- 3** Press and hold the button, letting go a few seconds before the desired volume is reached. The new water volume is now programmed for the capsule type used during the setting.

- i** The programming is specific to each capsule type. Cup sizes may be programmed from 20 ml / 0.68 fl oz. to 535 ml / 18 fl oz.

CAUTION: for proper machine usage, please do not open the machine head while the coffee is brewing, wait until the coffee button goes back to steady white. If you want to stop the brewing earlier, please press once on the coffee button and wait until the machine stops before opening the machine head.

NOTE: Once a customer-specific volume is programmed by the user, every time that capsule type is inserted in the machine, the preparation will stop at the user-programmed cup size. If you wish to come back to the default parameters see the paragraph **“Reset to factory settings”**.

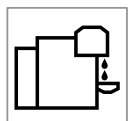
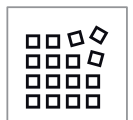

CLEANING

Clean your machine on a monthly basis, when you start having coffee residue inside the machine head or after a long period of non-use.

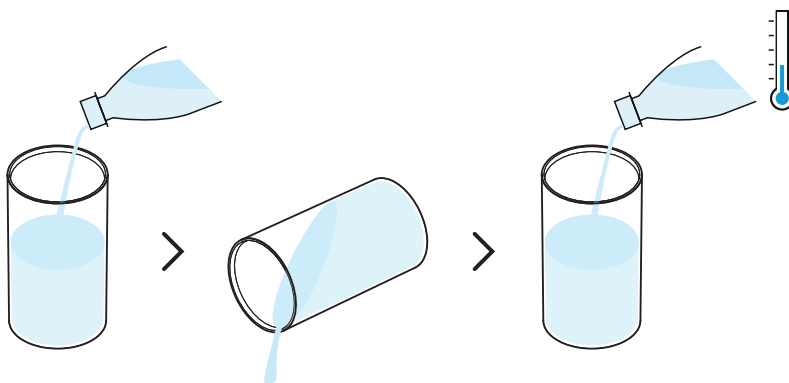

- 1** Rinse and clean the water tank and the lid before filling it with fresh drinking water.

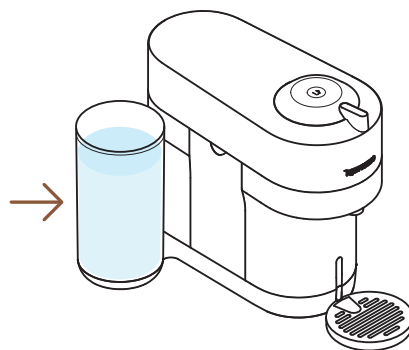

- 2** Put the water tank back in position on the machine.

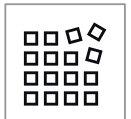

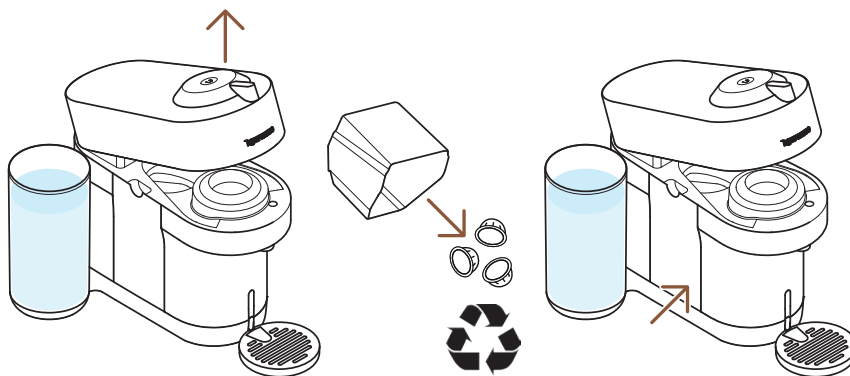

- 3** With machine on, unlock and open the machine and let the used capsule be ejected. Empty and rinse the capsule container and the drip tray and put them back in place. Don't forget to recycle your **Nespresso** capsules.*

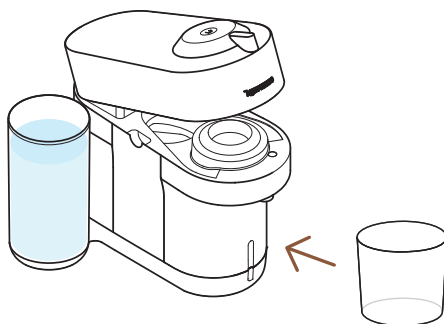

- 4** Remove the cup support and place an empty container (of at least 1 L / 34 fl oz.) under the coffee outlet.

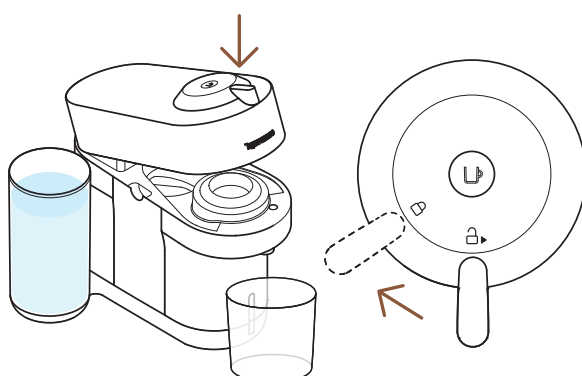

- 5** Close the machine head and turn the lever left towards lock position. Make sure no capsules are present in the machine before starting the rinsing procedure.

* THIS IS **NESPRESSO**. THIS IS RECYCLABLE. For more information about recycling your **Nespresso** capsules, visit www.nespresso.com

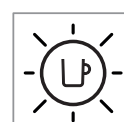
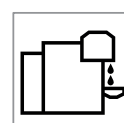
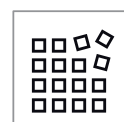
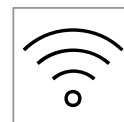
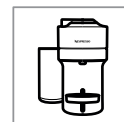

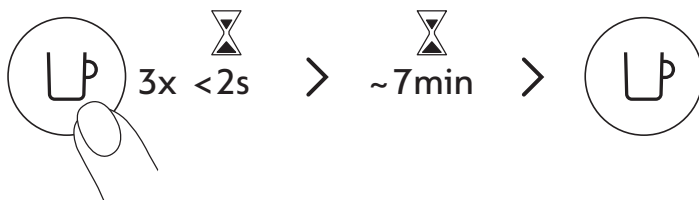

6 Press the button 3 times within 2 seconds to start rinsing. With the light blinking orange, let the rinsing procedure complete automatically.

i It should take less than 2 minutes before the rinsing process begins and water starts to flow. This operation may take up to 7 minutes and will stop automatically when the cycle is complete. the procedure can be stopped at any time by pressing the button.

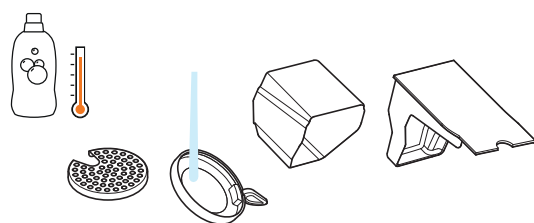

7 Wash the capsule container, the cup support and the drip tray with hot water and mild odorless detergent.

CAUTION: Do not use any strong or abrasive cleaning agent or solvent cleaner. Do not put the machine in a dishwasher. Never immerse the appliance or part of it in water.

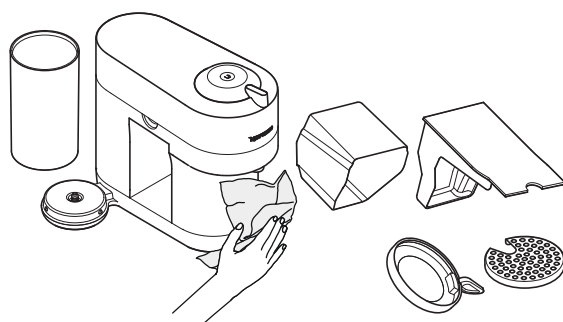

8 Dry with a clean and fresh towel

CAUTION: Clean the coffee outlet regularly with a clean damp cloth. Always use soft cloths to clean the machine.

NOTE: Water may accumulate inside the machine's head, please dry visible parts with a clean dry cloth.

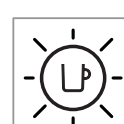
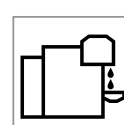
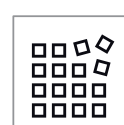
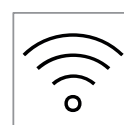
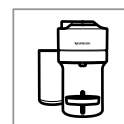

DESCALING

Descaling your machine will ensure that it functions properly throughout its lifetime and will make your coffee experience as incomparable as it was the first day. Your machine will indicate when descaling is needed by blinking orange 3 times before steady white.



i The descaling procedure takes ~20 minutes and **cannot be interrupted**.

NOTE: Please carefully read the descaling instructions before starting.

You will need:

- A descaling kit available on www.nespresso.com
- An empty container (1L / 34 fl oz.)

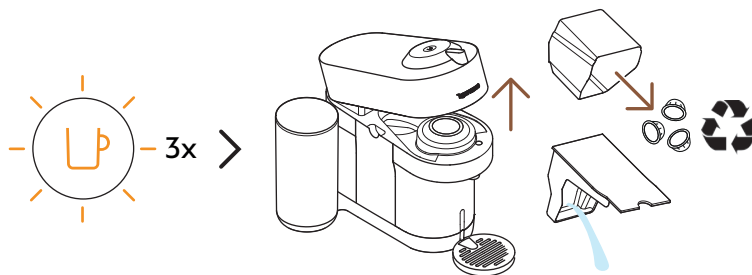

1 With the button blinking orange 3 times: Unlock and open the machine head and let the used capsule be ejected. Empty the capsule container and the drip tray and place them back in position on the machine. Don't forget to recycle your **Nespresso** capsules.*

* THIS IS **NESPRESSO**. THIS IS RECYCLABLE. For more information about recycling your **Nespresso** capsules, visit www.nespresso.com

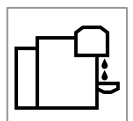
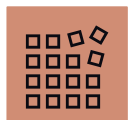

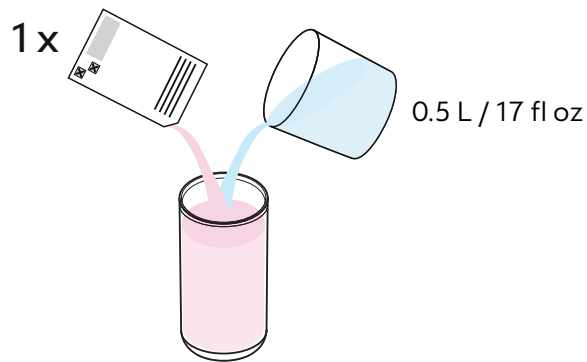

- 2** Fill the water tank with 0.5 L / 17 fl oz. of water and add 1 unit of **Nespresso** descaling liquid.

CAUTION: Please note that the descaling solution can be harmful. Avoid contact with eyes, skin and surfaces.

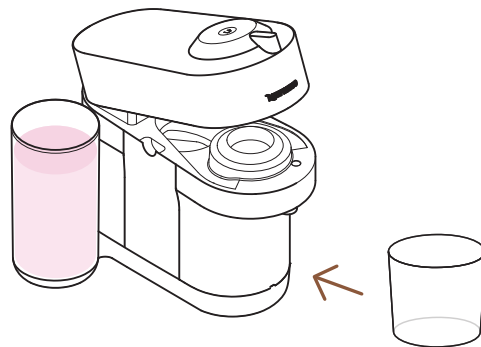

- 3** Remove the cup support and place an empty container (of at least 1 L / 34 fl oz.) under the coffee outlet.

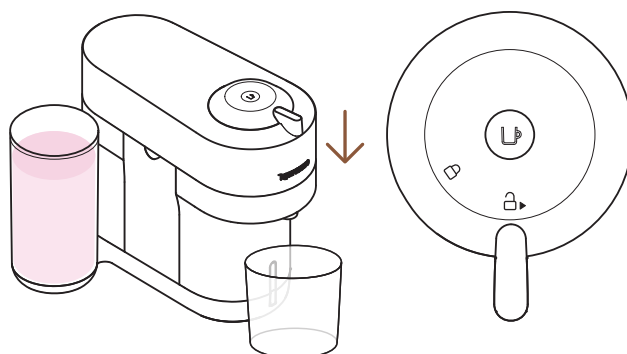

- 4** With the machine on, close the machine head and leave the lever in unlock position.

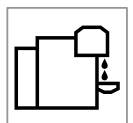

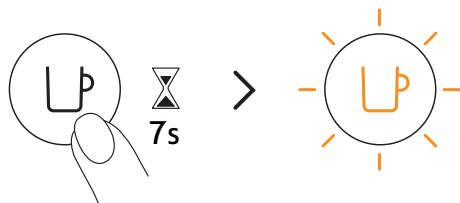

- 5** Hold the button for at least 7 seconds or until you see the light turn off. The button will start blinking orange rapidly.

CAUTION: You now have 45 seconds to enter the descaling mode, otherwise the machine will return to the brewing mode.

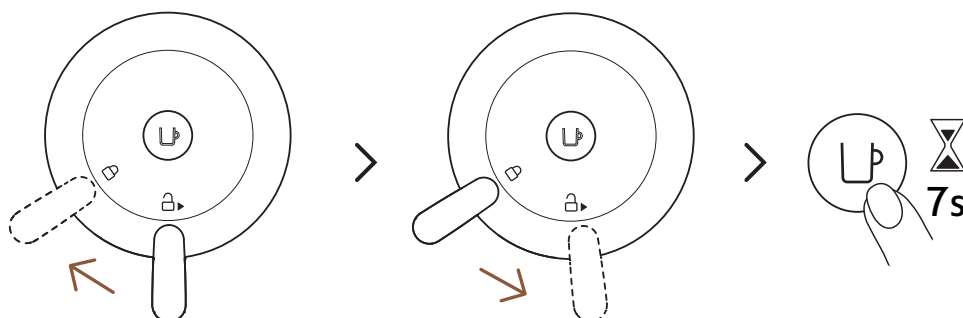

- 6** Lock the machine head by turning the lever left until the lock symbol and then unlock the lever by turning right to the unlock position. Press and hold the button again for approximately 7 seconds or until the light turns off. The button will start blinking orange rapidly.

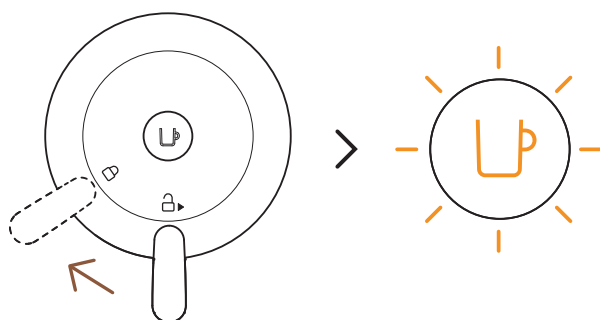

- 7** To enter the descaling mode, lock the machine by turning the lever left towards the lock position. The light should still be blinking orange quickly. This is an indication that you have entered descaling mode.

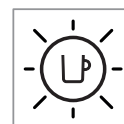
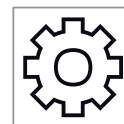
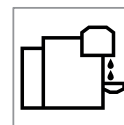
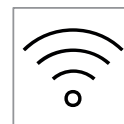
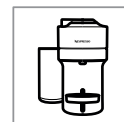

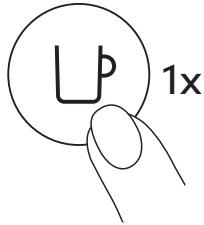

- 8** Press the coffee button once to begin the descaling process. The light will continuously blink orange throughout the process.

- i** The machine will stop automatically when the first phase of descaling is completed.

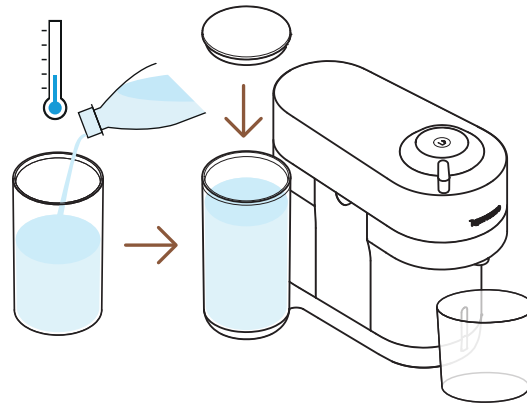

- 9** At the end of the descaling process, it is time to rinse the machine. Rinse the water tank and drip tray thoroughly. Fill the water tank with fresh drinking water and put it back in place. Empty the container and place it back under the coffee outlet.

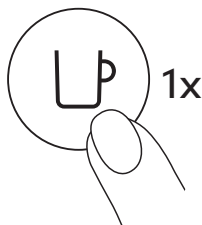

- 10** Press the button to rinse the machine. When the button stops blinking rapidly, the descaling procedure is completed.

- i** The machine will stop automatically when the procedure is completed.

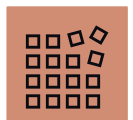

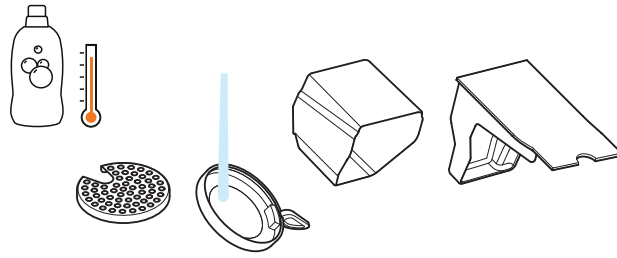

- 11** Wash the capsule container, the cup support and the drip tray with hot water and mild odorless detergent.

CAUTION: Do not use any strong or abrasive cleaning agent or solvent cleaner. Do not put the machine in a dishwasher. Never immerse the appliance or part of it in water.

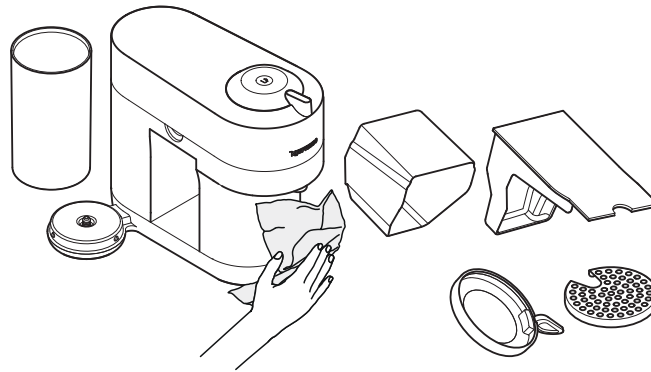

- 12** Dry the machine with a clean and fresh towel. Let the machine dry for 10 minutes before using it.

NOTE: Water may accumulate inside the machine's head during cleaning. If this happens, please dry visible parts with a clean dry cloth.

NOTE: the machine can only enter descaling mode after 30 or more coffees have been brewed



EMPTYING THE SYSTEM

Emptying the system is a process that could be done before a period of non-use, for frost protection or prior to sending the machine for a repair.

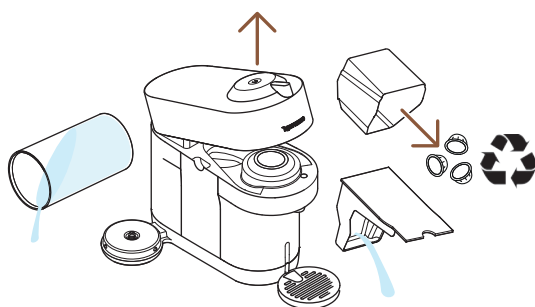

- 1 Empty the water tank, open the machine head, and let the used capsule be ejected. Empty the capsule container and the drip tray. Don't forget to recycle your **Nespresso** capsules.*

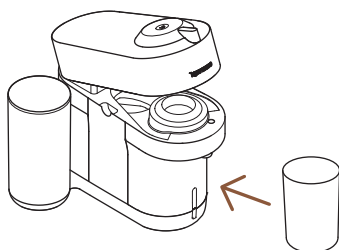

- 2 Place them back in position on the machine, remove the cup support and place an empty container (0.5 L / 17 fl oz.) under the coffee outlet.

* THIS IS **NESPRESSO**. THIS IS RECYCLABLE. For more information about recycling your **Nespresso** capsules, visit www.nespresso.com

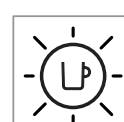
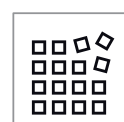
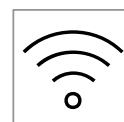
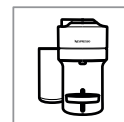

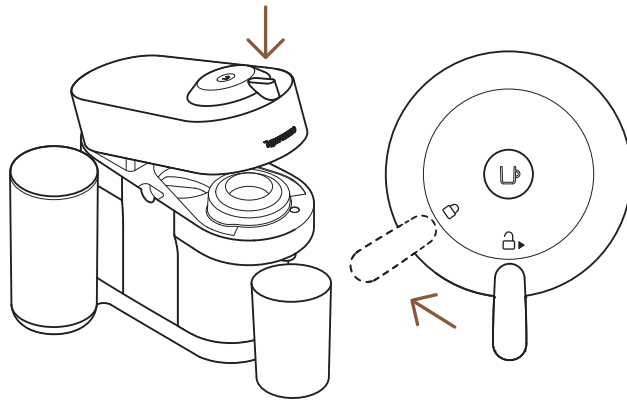

3 With machine plugged and on, turn the lever towards the lock position.

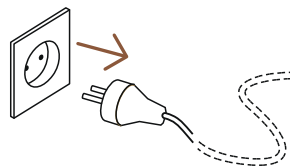

4 Unplug the machine

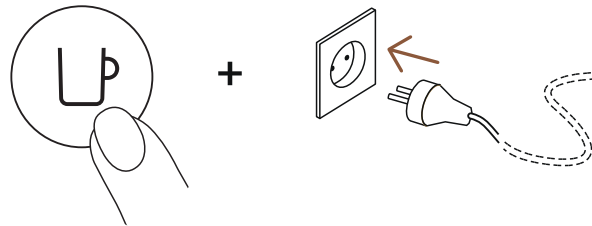

5 Press and hold the button while plugging the machine.

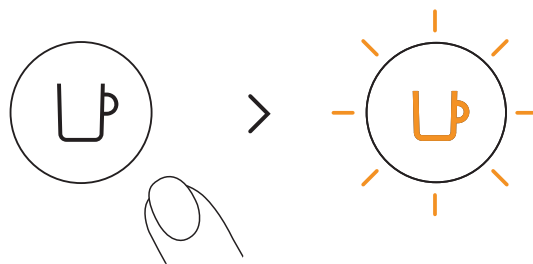

6 Release the button. It will blink orange and the emptying process will start.

i It will take approximately 30 seconds for the machine to complete the emptying process. The machine turns off automatically when it is empty.



RESET TO FACTORY SETTINGS

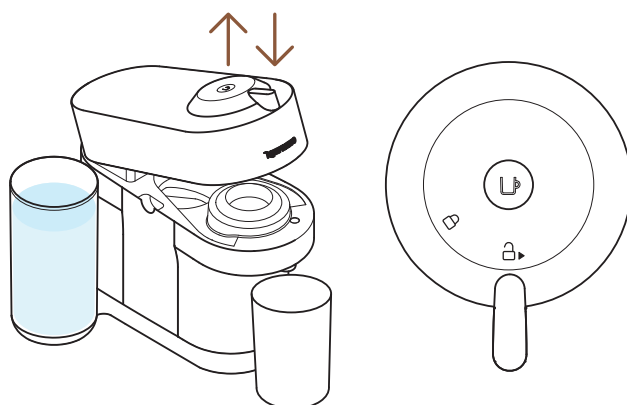

- 1 With the machine plugged, open then close the machine head before leaving the lever on the **unlock** position.

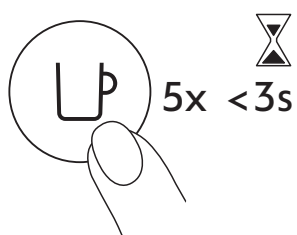

- 2 Press the button 5 times within 3 seconds. The machine is now programmed with the factory settings.

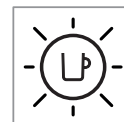
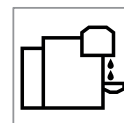
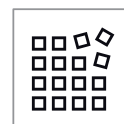
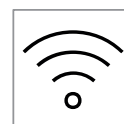
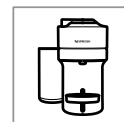

BLINKING SUMMARY

You want to learn more about the Vertuo Pop+ blinkings?
Please watch the following video:

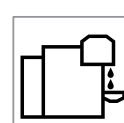
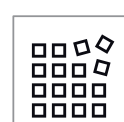
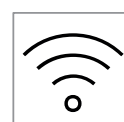

TROUBLESHOOTING

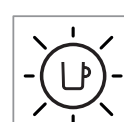
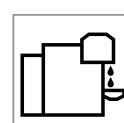
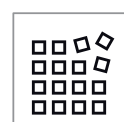
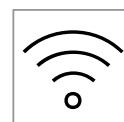
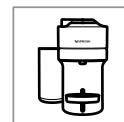

No light on the button

- The machine has turned OFF automatically; push the button or “UNLOCK” the machine.
- Check the mains, plug, voltage, and fuse.

No coffee, no water.

- Check that the water tank is filled.
- Check that a fresh capsule is inserted in correct position, that the lever is properly locked and push the button to start.
- Descal if necessary.
- Open the machine head and let the capsule be ejected. Then perform a cleaning as per cleaning section.

Coffee is not hot enough.

- Preheat cup with hot drinking water from the tap.
- Descal if necessary.

Leakage or unusual coffee flow.

- Check that the water tank is well positioned.
- Descal if necessary.

Machine turns to “OFF mode”

- To save energy the machine will turn off after 2 minutes of non-use.
- The machine can be turned “OFF” manually at any time (when not in use) by pressing and holding the button for 3 seconds.

Coffee grounds in the cup.

- Perform the cleaning procedure twice.
- See paragraph on **“Cleaning”**.

The machine doesn't start and has light steady on. If blinking, see next points.

- Check that lever is properly locked.
- If you want to brew a Coffee or Espresso, check that a fresh capsule is inserted in correct position, that the lever is properly locked and push the button to start.
- If you are cleaning, descaling or emptying the system, check that no capsule is inserted then close, lock the machine and push the button to start one of these operations.

The machine doesn't start and light blinks alternately; 1 blink and 1 pause.

- Fill the water tank and push button to start.
- Check that lever is properly locked.

Light blinks while machine is running

- If coffee is flowing normally, this indicates the machine is working properly.
- If only water is flowing, the machine is executing a user request for either cleaning, descaling or emptying the system. Please refer to the corresponding chapter
- Turn the machine to “OFF mode” by pushing the button for 3 seconds and then push it again to turn the machine ON. Now wait approximately 20 minutes to allow the machine to cool down after extensive use.

Light blinks and machine is not running.

- It will take some time before the coffee flow comes out (due to barcode reading and pre-wetting the coffee).
- Check that a fresh capsule is inserted in correct position, that the lever is properly locked and push the button to start.
- Fill the water tank and press the button to start.
- Turn the machine to “OFF mode” by pushing the button for 3 seconds and then push it again to turn the machine ON. Now wait approximately 20 minutes to allow the machine to cool down after extensive use.

Light blinks alternately 2 blinks and 1 pause continuously. Machine is not running.

- During regular Coffee/Esspresso preparation:
 - 1) Unlock the lever and open the machine head to check that a fresh undamaged capsule is inserted in the correct position.
 - 2) Check that the lever is in “LOCKED” position.
 - 3) Check that the water tank is filled.
- During Descaling, Emptying and Cleaning:
 - 1) Check that capsule is ejected.
 - 2) Check that the lever is in “LOCKED” position.
- During Programming Volume:
 - 1) Check if a capsule has been well inserted.
 - 2) Please refer to the corresponding chapter

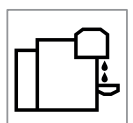

**Light alternately
blinking 3 times and
then steady on.**

- If problem persists:
 - 1) Unlock the lever and open machine head
 - 2) Replace capsule (if needed).
 - 3) Disconnect powercord from the outlet and plug the machine back into outlet after 10 seconds.
 - 4) Close the head and press the button to turn ON and press again to start brewing. If problem persists, call **Nespresso**.
- Descaling needed: the machine can be used only a few times after the descaling alert appears before it becomes necessary.

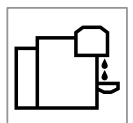
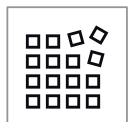

SPECIFICATIONS

Power	~220–240 V, 50–60 Hz, 1300–1500 W US, CA: 120 V, 60 Hz, 1500 W MX: 127 V~, 60 Hz, 1650 W
Frequency	2.402–2.480 GHz
RF Output power (EIRP)	Bluetooth 4 dBm Max. e.i.r.p. and Wi-Fi <20 dMm max. e.i.r.p.
Standby	0.39 W/h
Power saving mode	Auto off: 2 min
Heat-up time	30 seconds (head closed and locked)
Movable cup support for large recipes	Yes, 2 positions
Cable length from device connection	90 cm / 35.4 in
Dimensions (W x D x H)	22 x 35.6 x 26.5 cm / 8.6 x 14 x 10.4 in
Weight	Vertuo Pop+: 3.6 kg / 7.9 lbs Vertuo Pop+ Deluxe: 3.7 kg / 8.1 lbs
Water tank capacity	Vertuo Pop+: 750 ml / 25.4 fl oz Vertuo Pop+ Deluxe: 1.1 L / 37.2 fl oz
Capsule container capacity	8 espresso or 5 mug capsules

MACHINE CODES

Nespresso	Breville	Delonghi
GCV6 GDV6	BNV520, BNV550, BNV530, BNV560, BNV540, BNV570	ENV92B, ENV92BAE, ENV92Y, ENV92YAE, ENV92AAE, ENV95S, ENV95SAE

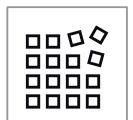

CLIQUEZ ET CHOISISSEZ VOTRE LANGUE

FR



MESURES DE SÉCURITÉ



VUE D'ENSEMBLE



CONNECTIVITÉ



PREMIÈRE UTILISATION



PRÉPARATION DU CAFÉ



ADAPTER LES VOLUMES DE CAFÉ



NETTOYAGE



DÉTARTRAGE



VIDANGE DU SYSTÈME



**RÉINITIALISATION DES PARAMÈTRES
D'USINE**



RÉSUMÉ DES CLIGNOTEMENTS



DÉPANNAGE



SPÉCIFICATIONS

CONSIGNES DE SÉCURITÉ

ATTENTION: Avant d'utiliser votre machine **Nespresso**, veuillez vous reporter à la [notice de sécurité](#) afin d'éviter blessure ou dommage.

RECYCLAGE ET PROTECTION DE L'ENVIRONNEMENT

Cet appareil est conforme à la Directive de l'UE 2012/19/CE. Les matériaux d'emballage et l'appareil contiennent des matières recyclables. Votre appareil contient des matériaux valorisables qui peuvent être récupérés ou recyclés. Le tri des matériaux en différentes catégories facilite le recyclage des matières premières valorisables. Déposez l'appareil à un point de collecte. Pour obtenir des renseignements sur le recyclage, contactez les autorités locales.

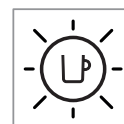
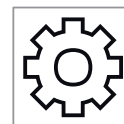
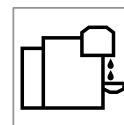
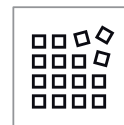
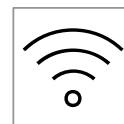
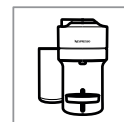

PRÉSENTATION DE LA MACHINE

PRÉSENTATION DE LA MACHINE

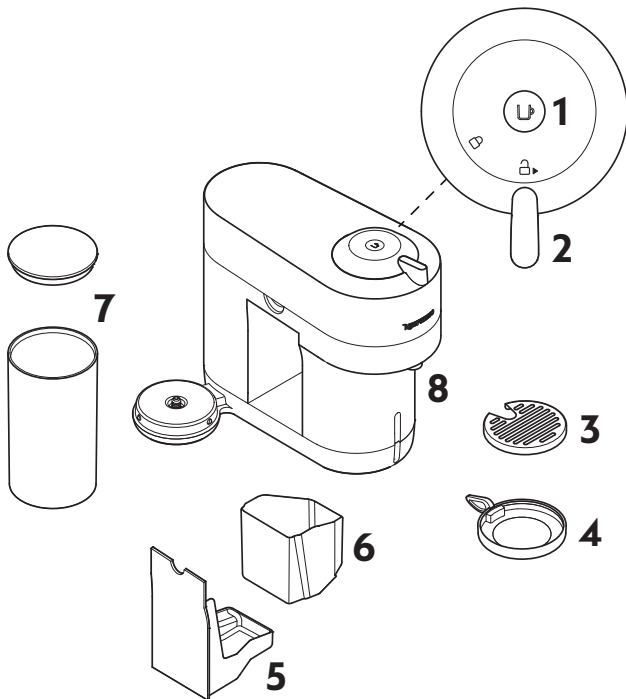

- 1 MARCHE/ARRÊT et Bouton Café
- 2 Levier de verrouillage/déverrouillage
- 3 Grille d'égouttage
- 4 Support de tasse réglable
- 5 Bac d'égouttage
- 6 Collecteur de capsules usagées
- 7 Réservoir d'eau et couvercle
- 8 Embout de sortie du café

CONTENU DE L'EMBALLAGE



- 1 Machine à café
- 2 Boîte de capsules **Nespresso**
- 3 Ensemble de bienvenue **Nespresso**
- 4 Instructions de sécurité
- 5 Guide de démarrage rapide
- 6 Garantie

i Déballage : il se peut qu'il y ait un peu de poussière sur la surface de la machine en raison des matériaux recyclés utilisés pour l'emballage. Ce n'est pas dangereux, il suffit de nettoyer la machine avec un chiffon doux.

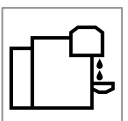
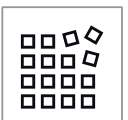

OUVERTURE/FERMETURE

OUVERTURE

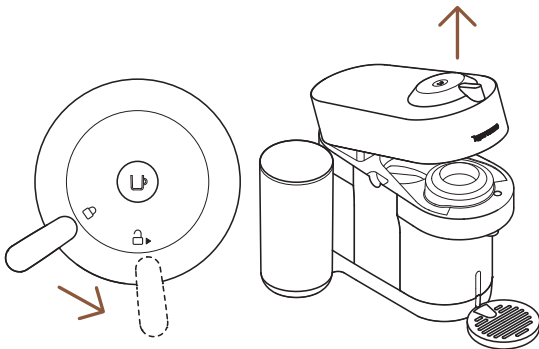

FERMETURE

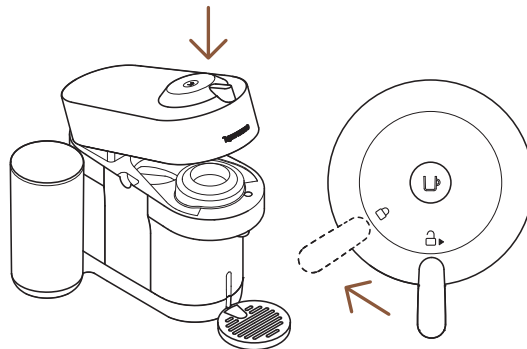

ATTENTION : pour une utilisation correcte de la machine, n'ouvrez pas la tête de la machine pendant la préparation du café, attendez que le bouton de café redevienne blanc. Si vous souhaitez arrêter la préparation plus tôt, appuyez une fois sur le bouton café et attendez que la machine s'arrête avant d'ouvrir la tête de la machine.

LE SYSTÈME VERTUO

COMPATIBILITÉ AVEC LES CAPSULES

**P****Ristretto**

(25 ml / 0,84 oz. liq.)

Espresso

(40 ml / 1,35 oz. liq.)

**M****Double Espresso**

(80 ml / 2,7 oz. liq.)

Gran Lungo

(150 ml / 5,07 oz. liq.)

**G****Café**

(230 ml / 7,77 oz. liq.)

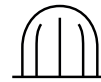
**TG****Alto, Style infusé à froid**

(355 ml / 12 oz. liq.)

Carafe

(535 ml / 18 oz. liq.)

ACCESSOIRES ADAPTÉS



Accessoires adaptés

**Ristretto****Espresso****Double Espresso****Gran Lungo****Café (P)****Café (M)****Verre Reveal**

Accessoires non adaptés

**Café (G)****Carafe**

Découvrez notre collection complète d'accessoires sur www.nespresso.com



MARCHE/ARRÊT

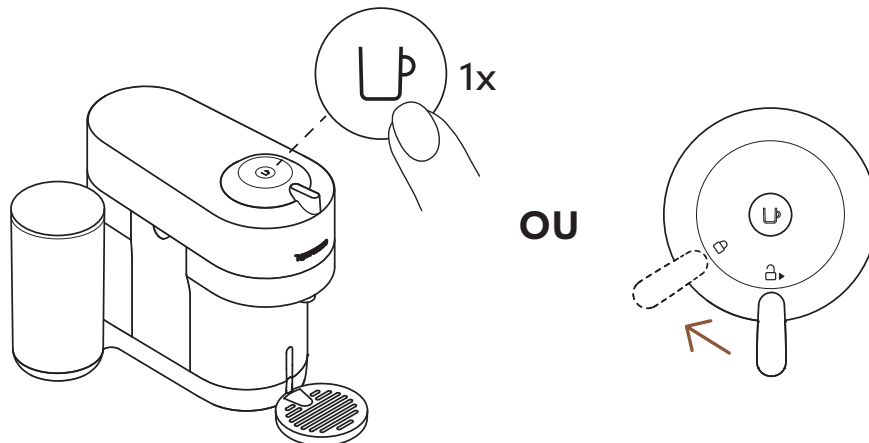

MARCHE

Une fois la machine branchée, mettez-la en marche en appuyant une fois sur le bouton ou en fermant le levier en position de verrouillage (avec la tête fermée).

- i** La lumière clignotera pendant environ 30 secondes pendant que la machine chauffe. Lorsque le voyant est allumé, la machine est prête.

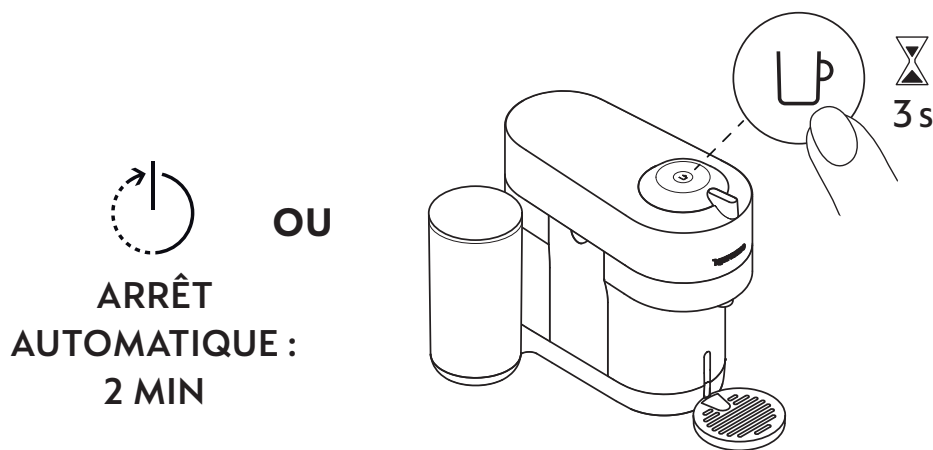

ARRÊT

Dans un souci d'économie d'énergie, la machine s'éteint après 2 minutes de non-utilisation.

- i** La machine peut être éteinte manuellement à tout moment (lorsqu'elle n'est pas utilisée) en appuyant sur le bouton et en le maintenant enfoncé pendant 3 secondes.

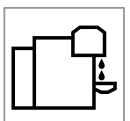

CONNECTIVITÉ

POURQUOI JUMELER VOTRE MACHINE VERTUO POP+ ?

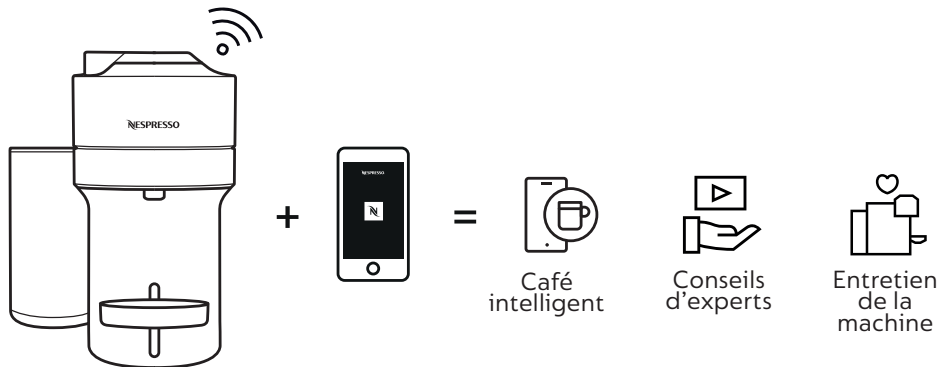

LES AVANTAGES DE CONNECTER VOTRE MACHINE VERTUO POP+

- **Café intelligent :** Gardez toujours une longueur d'avance et bénéficiez des dernières innovations de **Nespresso** en matière de café en gardant votre machine au top et à jour.
- **Conseils d'experts :** Bénéficiez d'une assistance et de vidéos tutorielles simples pour accompagner votre parcours café via votre smartphone.
- **Entretien de la machine :** Recevez une notification instantanée sur la manière et le moment d'entretenir votre machine grâce à un guide facile à suivre sur le détartrage, le rinçage, le nettoyage, etc.

COMMENT CONNECTER VOTRE MACHINE VERTUO POP+ ?

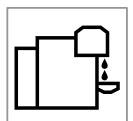
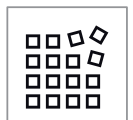

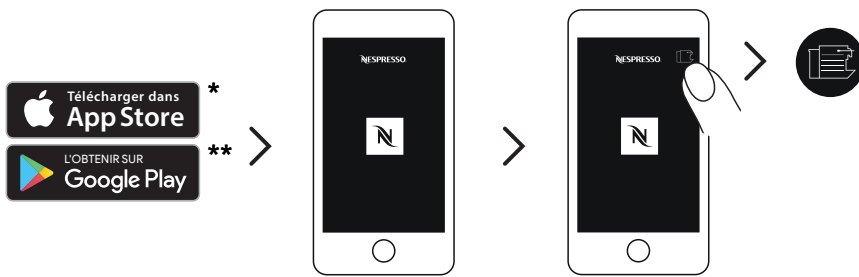

- 1 Téléchargez ou mettez à jour l'application **Nespresso**. Lancez l'application sur votre appareil mobile ou tablette. Cliquez sur l'icône machine en haut à droite de votre écran.

REMARQUE : pour des performances optimales et une expérience transparente, nous vous recommandons de connecter votre machine à un routeur Wi-Fi plutôt que d'utiliser un hotspot pour téléphone intelligent.

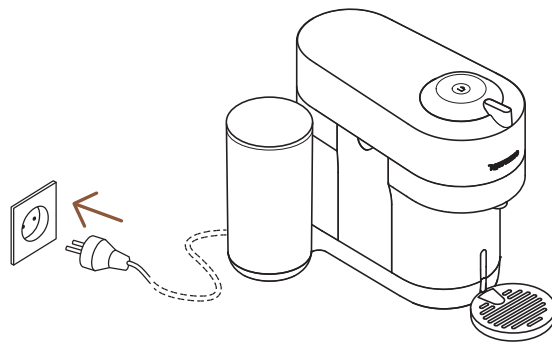

- 2 Branchez le cordon d'alimentation.

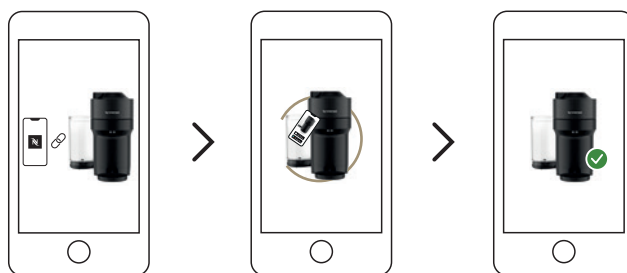

- 3 Suivez les instructions via l'application **Nespresso**.

ATTENTION: Lisez d'abord les consignes de sécurité pour éviter les risques de choc électrique mortel et d'incendie. Veuillez assurer la continuité de la mise à la terre lorsque vous branchez la machine sur la prise de courant.

- * App Store® est une marque d'Apple Inc. enregistrée aux États-Unis et dans d'autres pays.
- ** Google Play et le logo Google Play sont des marques commerciales de Google LLC.

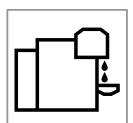

DÉSACTIVATION DU BLUETOOTH ET DU WIFI DE LA MACHINE

La machine est dotée d'un module de connectivité, activé par défaut. Il permet d'accéder à des fonctions supplémentaires qui améliorent votre expérience du café. Pour désactiver le module de connectivité, procédez comme suit :

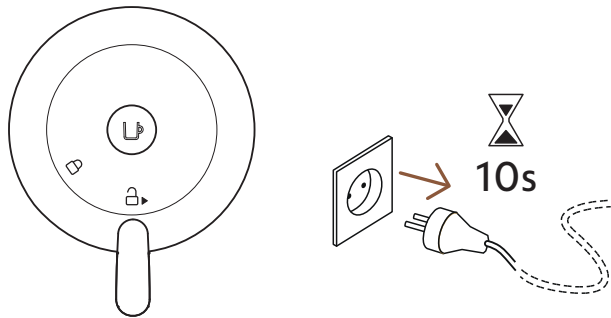

- 1 Avec la machine fermée et le levier en **position déverrouillée**, débranchez la machine pendant au moins 10 secondes.

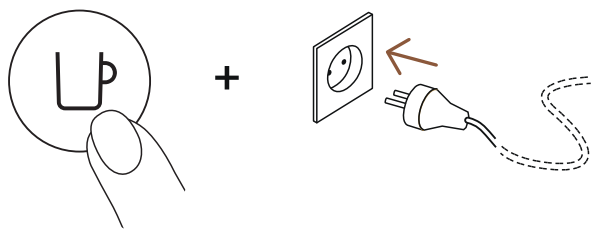

- 2 Appuyer sur le bouton et le maintenir appuyé tout en branchant la machine.
Le bouton clignotera en orange pour confirmer que le module de connectivité est maintenant désactivé.

- i** Suivez les mêmes étapes pour remettre le module de connectivité en marche. Le bouton clignotera en blanc pour confirmer que le module a été réactivé.



PREMIERS PAS

PREMIER RINÇAGE

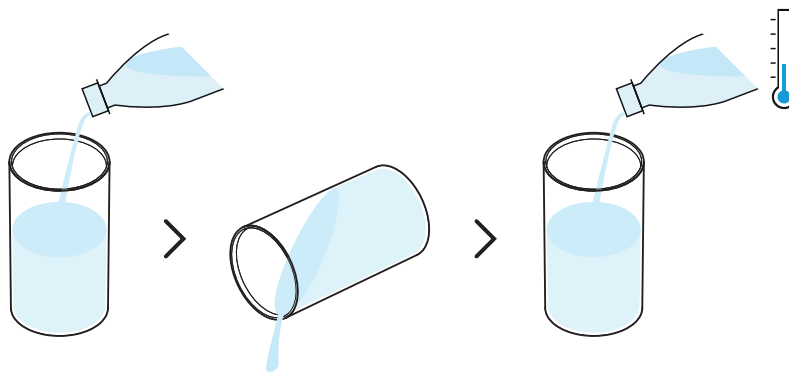

- 1** Rincez et nettoyez d'abord le réservoir d'eau et le couvercle avant de le remplir d'eau potable fraîche.

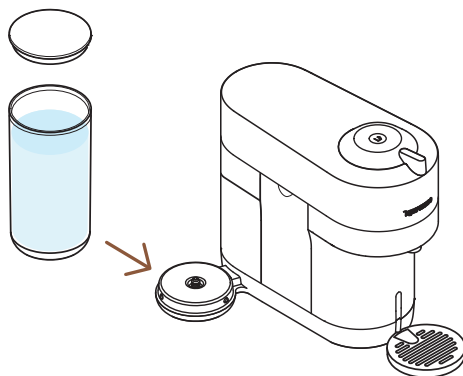

- 2** Fermez le réservoir d'eau avec le couvercle et mettez le réservoir d'eau en place en vous assurant qu'il est correctement fixé.

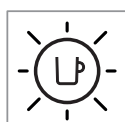
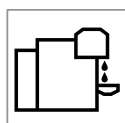
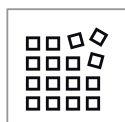
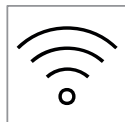

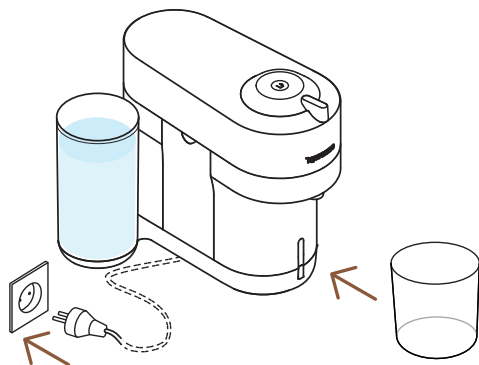

- 3** Avec la machine branchée, retirez le support de tasse et placez un récipient vide (d'au moins 1 L / 34 oz liq) sous la sortie de café.

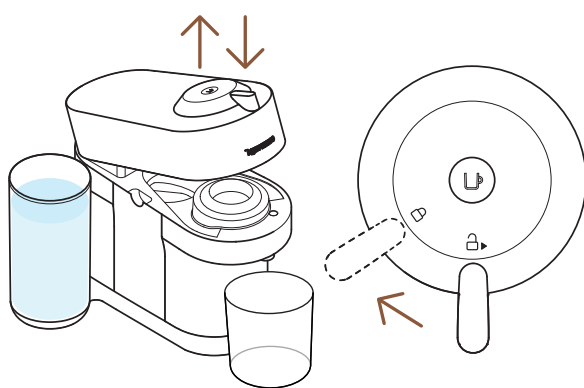

- 4** Ouvrir et fermer la machine. S'assurer que le levier est en position de verrouillage.
- i** Le voyant clignotera pendant que l'appareil chauffe. Cela prendra environ 30 secondes. Lorsque le voyant devient fixe, la machine est prête. Assurez-vous qu'aucune capsule n'est insérée.

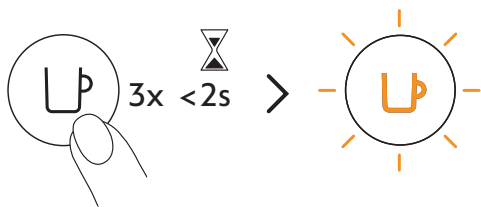

- 5** Appuyez sur le bouton 3 fois en moins de 2 secondes. Lorsque le voyant clignote en orange, laissez la procédure de rinçage se terminer automatiquement. Lorsque le voyant devient blanc fixe, le cycle est terminé.
- i** Il ne faut pas plus de 2 minutes pour que le processus de rinçage commence et que l'eau s'écoule. Cette opération peut prendre jusqu'à 7 minutes.

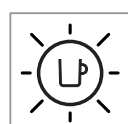
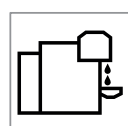
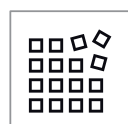
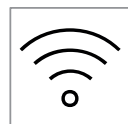
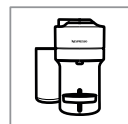

PRÉPARATION DU CAFÉ

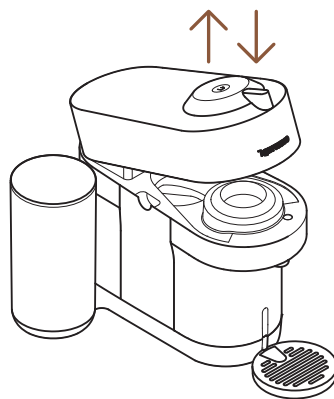

1 Ouvrir et fermer la machine.

i Le voyant de la touche café clignote pendant que la machine chauffe. Lorsque le voyant devient fixe, la machine est prête.

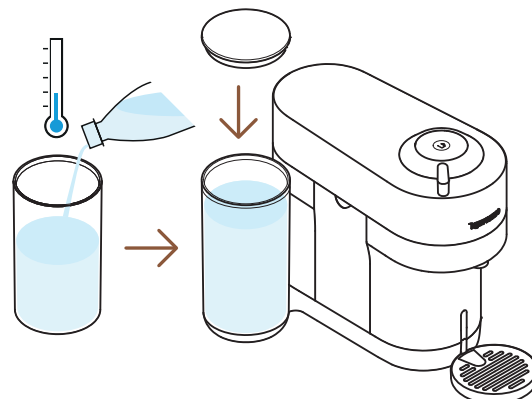

2 Remplissez le réservoir d'eau avec de l'eau potable fraîche et remettez-le en place.

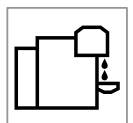

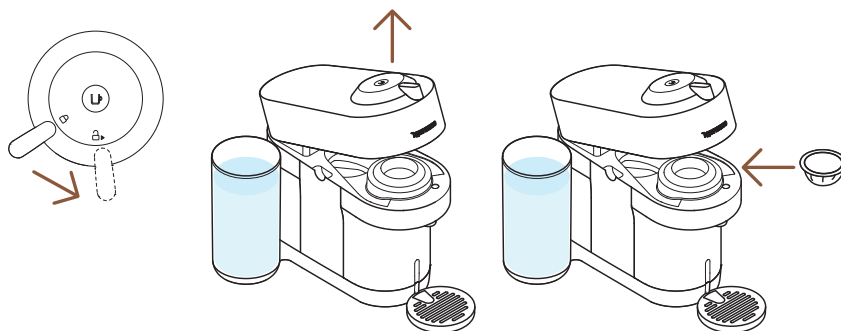

- 3** Déverrouillez et ouvrez complètement la tête de la machine et insérez une capsule Vertuo avec la forme du dôme vers le bas.

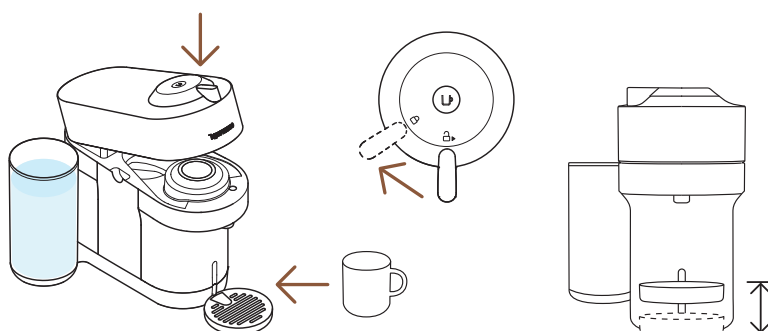

- 4** Fermez la tête de la machine et verrouillez-la en tournant le levier vers la gauche jusqu'à la position de verrouillage et placez une tasse. Le support de tasse peut être réglé pour s'adapter à votre taille de tasse.

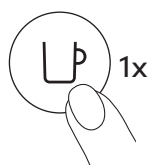

- 5** Démarrez l'infusion en appuyant une fois sur le bouton.

ATTENTION : pour une utilisation correcte de la machine, n'ouvrez pas la tête de la machine pendant la préparation du café, attendez que le bouton de café redevienne blanc. Si vous souhaitez arrêter la préparation plus tôt, appuyez une fois sur le bouton café et attendez que la machine s'arrête avant d'ouvrir la tête de la machine.

- i** En raison de la lecture du code-barres, de la pré-humidification du café et du temps d'infusion, il faut un certain temps avant que le café ne commence à couler. La machine reconnaît automatiquement la capsule insérée et sélectionne les paramètres de préparation du café et la longueur de la tasse définis par les experts en café **Nespresso** pour extraire au mieux les mélanges de café.

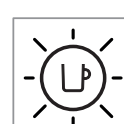
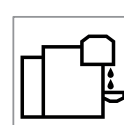
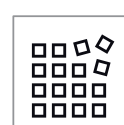
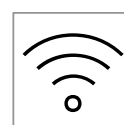
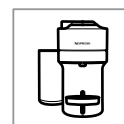

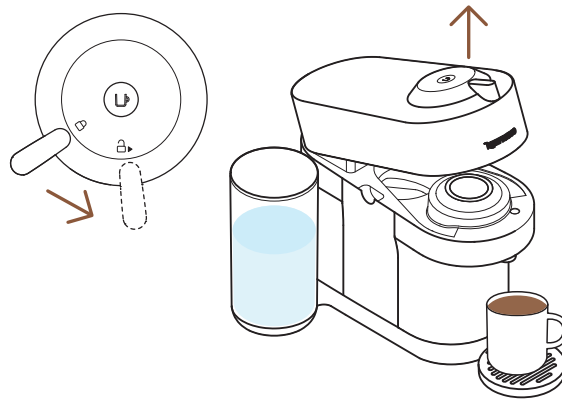

- 6** Lorsque le café ne coule plus, ouvrez la tête de la machine en tournant le levier vers la droite en position de déverrouillage pour éjecter automatiquement la capsule et déguster votre café.



- 7** N'oubliez pas de recycler vos capsules **Nespresso**.*

* C'EST **NESPRESSO**. C'EST RECYCLABLE. Pour plus d'informations sur le recyclage de vos capsules **Nespresso**, visitez le site www.nespresso.com

DÉCOUVREZ NOTRE MODE CRÉATIONS DE CAFÉ.



Avec cette machine, **Nespresso** vous propose une fonction spécifique pour concentrer vos extractions de café afin de créer vos propres recettes.

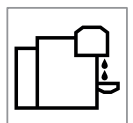

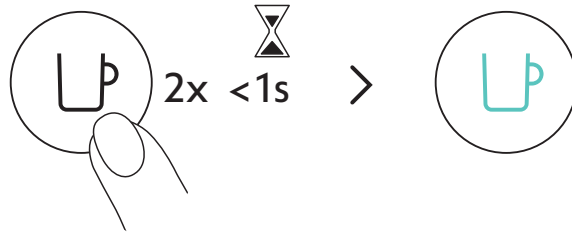

Lorsque votre machine est allumée, double-cliquez sur le bouton café. Il clignotera en turquoise et votre café sera concentré, optimisant le goût du café dans les recettes avec ajouts (lait, crème, sur glace...). Pour une expérience café incomparable.

40 ml / 1,35 oz. liq.	80 ml / 2,7 oz. liq.	150 ml / 5,07 oz. liq.	230 ml / 7,07 oz. liq.	355 ml / 12 oz. liq.	535 ml / 18,8 oz. liq.
✓	✓	✓	✓	✗	✗
25 ml / 0,85 oz. liq.	40 ml / 1,35 oz. liq.	40 ml / 1,35 oz. liq.	80 ml / 2,7 oz. liq.		

Pour profiter pleinement des avantages de ce mode, nous recommandons de préparer notre gamme Café+ en utilisant uniquement les tailles de tasses officielles. Pour obtenir les meilleurs résultats en tasse, nous ne recommandons pas d'infuser nos TG (Alto Ambrato, Alto Onice), Style infusion à froid et Carafe avec ce mode.

REMARQUE : une mise à jour de votre machine via l'application **Nespresso** peut être nécessaire pour activer ce mode.



Découvrez comment perfectionner votre machine avec notre gamme Aeroccino sur www.nespresso.com



ADAPTER LES VOLUMES DE CAFÉ

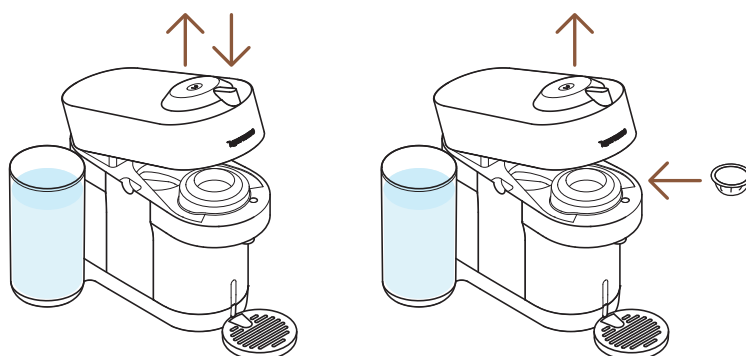

- 1** Avec la machine allumée, ouvrez la machine et insérez la capsule que vous voulez programmer.

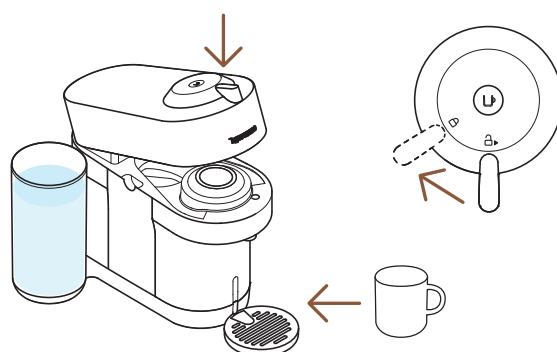

- 2** Fermez la tête de la machine, tournez le levier à gauche vers la position de verrouillage et placez une tasse.

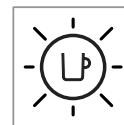
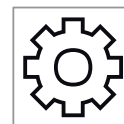
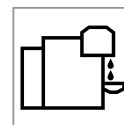
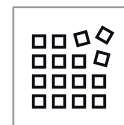
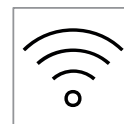
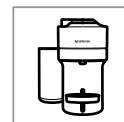

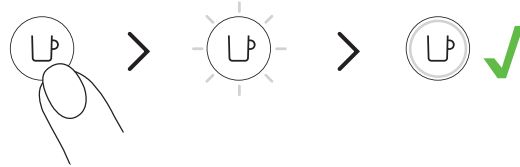

- 3** Appuyez sur le bouton et maintenez-le enfoncé, en le relâchant quelques secondes avant que le volume souhaité ne soit atteint. Le nouveau volume d'eau est maintenant programmé pour le type de capsule utilisé lors du réglage.

- i** Il existe une programmation différente pour chaque type de capsule. Le format de tasse peut être programmé de 20 ml / 0,68 oz liq à 535 ml / 18 oz liq.

ATTENTION : pour une utilisation correcte de la machine, n'ouvrez pas la tête de la machine pendant la préparation du café, attendez que le bouton de café redevienne blanc. Si vous souhaitez arrêter la préparation plus tôt, appuyez une fois sur le bouton café et attendez que la machine s'arrête avant d'ouvrir la tête de la machine.

À NOTER: Une fois qu'un volume spécifique au client est programmé par l'utilisateur, chaque fois que ce type de capsule est inséré dans la machine, la préparation s'arrêtera à la taille de tasse programmée par l'utilisateur. Si vous souhaitez revenir aux paramètres par défaut, consultez le paragraphe « Réinitialisation aux paramètres d'usine ».

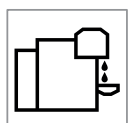

NETTOYAGE

Nettoyez votre machine tous les mois, lorsque vous commencez à avoir des résidus de café à l'intérieur de la tête de la machine ou après une longue période de non-utilisation.

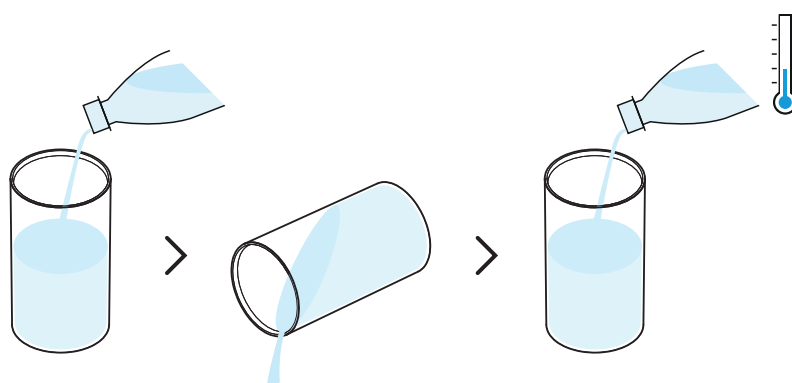

- 1** Rincez et nettoyez d'abord le réservoir d'eau et le couvercle avant de le remplir d'eau potable fraîche.

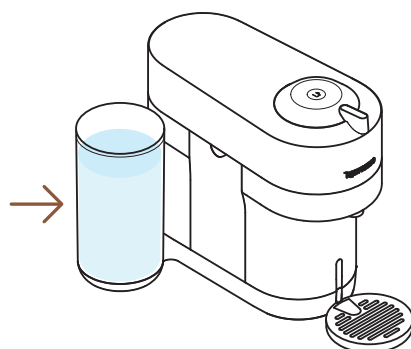

- 2** Remettre le réservoir en place.

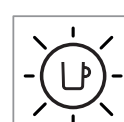
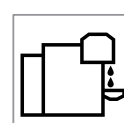
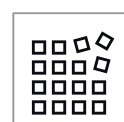
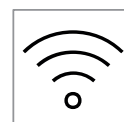
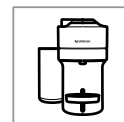

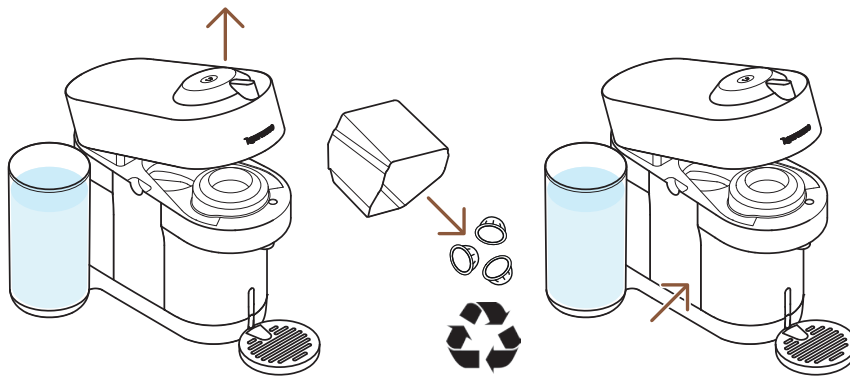

- 3** Avec la machine allumée, déverrouillez et ouvrez la machine et laissez la capsule usagée être éjectée. Videz et rincez le bac à capsules et le plateau d'égouttage et remettez-les en place. N'oubliez pas de recycler vos capsules **Nespresso**.*

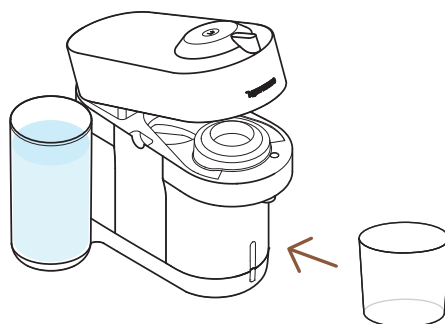

- 4** Retirer le support de tasse. Placer un récipient d'au moins 1 L / 34 oz liq. sous l'orifice de sortie du café.

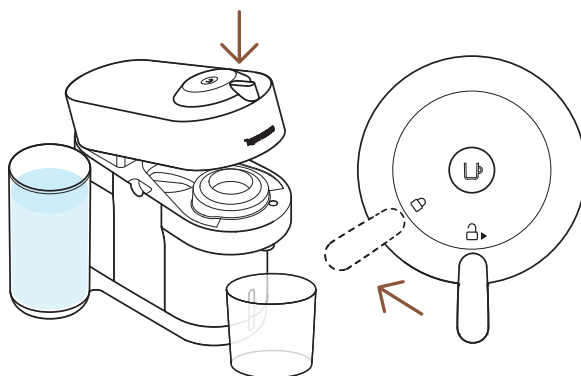

- 5** Fermez la tête de la machine et tournez le levier vers la gauche en position de verrouillage. Assurez-vous qu'il n'y a pas de capsules dans la machine avant de commencer la procédure de rinçage.

* C'EST **NESPRESSO**. C'EST RECYCLABLE. Pour plus d'informations sur le recyclage de vos capsules **Nespresso**, visitez le site www.nespresso.com

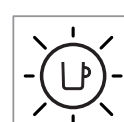
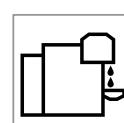
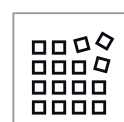
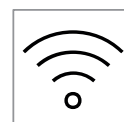
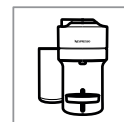

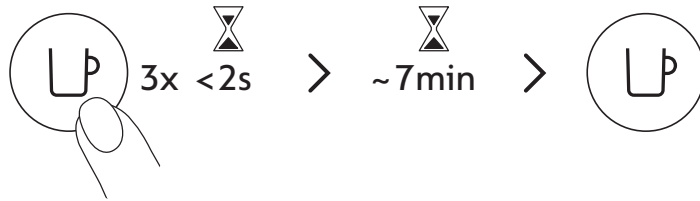

- 6** Appuyez sur le bouton 3 fois en moins de 2 secondes. Le voyant clignotant en orange, laissez la procédure de rinçage se terminer automatiquement.

- i** Il ne faut pas plus de 2 minutes pour que le processus de rinçage commence et que l'eau s'écoule. Cette opération peut durer jusqu'à 7 minutes et s'arrêtera automatiquement à la fin du cycle. Le processus peut être interrompu à tout moment en appuyant sur le bouton.

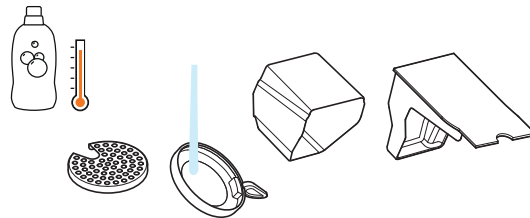

- 7** Lavez le contenant de la capsule, le support de la tasse et le plateau d'égouttage à l'eau chaude et avec un détergent doux et inodore.

ATTENTION: Ne pas utiliser de solvants ou de produits nettoyants puissants ou abrasifs. Ne pas mettre au lave-vaisselle. Ne jamais immerger la machine ou ses pièces dans l'eau.

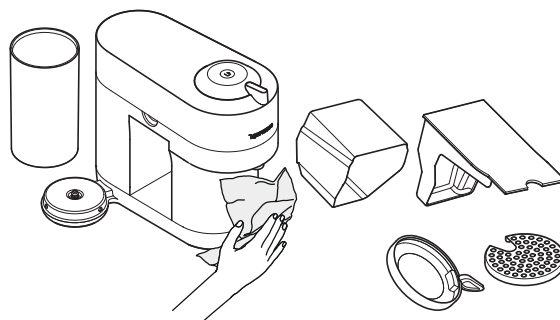

- 8** Sécher avec un linge propre et doux

ATTENTION: Nettoyez régulièrement l'écoulement du café à l'aide d'un chiffon propre et humide. Utilisez toujours des chiffons doux pour nettoyer la machine.

À NOTER: De l'eau peut s'accumuler à l'intérieur de la tête de la machine. Si c'est le cas, veuillez à sécher les parties visibles avec un linge propre et sec.

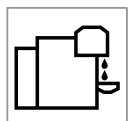
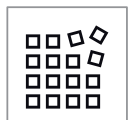

DÉTARTRAGE

Le détartrage de votre machine garantira son bon fonctionnement tout au long de sa durée de vie et rendra votre expérience du café aussi incomparable que le premier jour. Votre machine vous indiquera qu'un détartrage est nécessaire en clignotant 3 fois en orange avant de redevenir blanche.



i La procédure de détartrage dure environ 20 minutes et ne **peut pas être interrompue**.

NOTE : Veuillez lire attentivement les instructions de détartrage avant de commencer.

Vous aurez besoin :

- Une trousse de détartrage disponible sur www.nespresso.com
- Un récipient vide (1L / 34 oz liq)

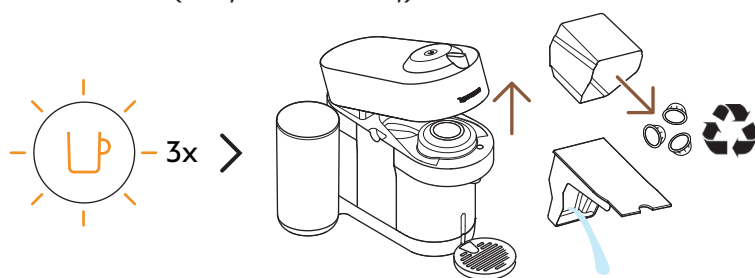

- 1** Le bouton clignote 3 fois en orange : Déverrouillez et ouvrez la tête de la machine et laissez la capsule usagée être éjectée. Videz le conteneur de la capsule et le bac de récupération et remettez-les en place sur la machine. N'oubliez pas de recycler vos capsules **Nespresso**.*

* C'EST **NESPRESSO**. C'EST RECYCLABLE. Pour plus d'informations sur le recyclage de vos capsules **Nespresso**, visitez le site www.nespresso.com

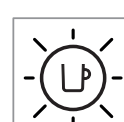
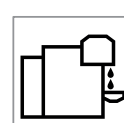
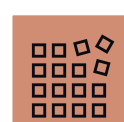
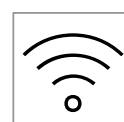

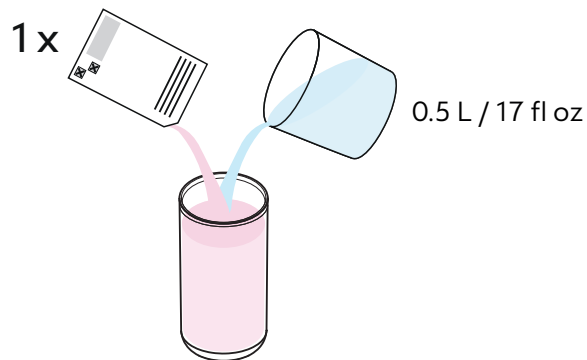

- 2** Mettre 0,5 L / 17 oz liq. d'eau dans le réservoir et ajouter la solution détartrante **Nespresso**.

ATTENTION: la solution détartrante peut être nocive.
Éviter tout contact avec les yeux, la peau et les surfaces.

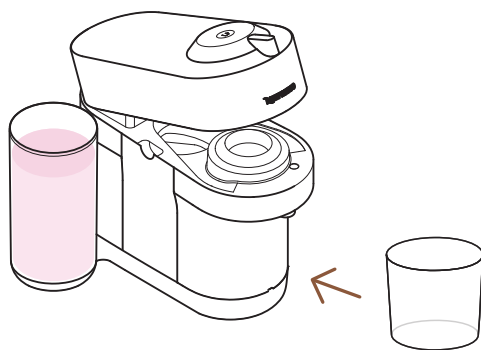

- 3** Retirez le support de tasse et placez un récipient vide (au moins 1 L / 34 oz liq) sous la sortie du café.

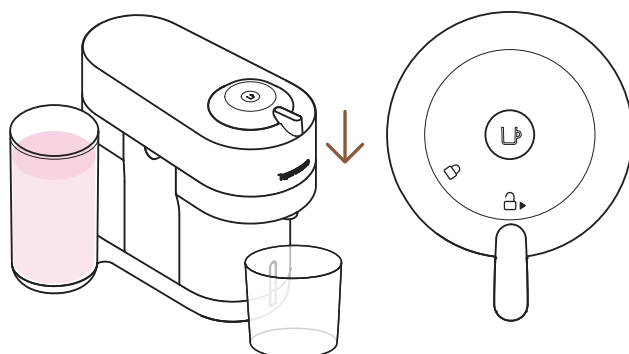

- 4** Lorsque la machine est en marche, fermez la tête de la machine et laissez le levier en position de déverrouillage.

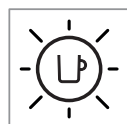
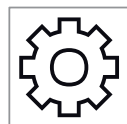
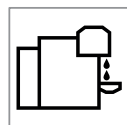
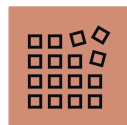
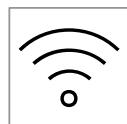

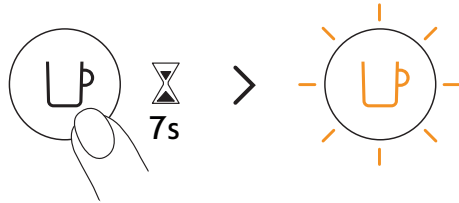

- 5** Maintenez le bouton enfoncé pendant au moins 7 secondes ou jusqu'à ce que la lumière s'éteigne. Le bouton se met à clignoter rapidement en orange.

ATTENTION: Vous avez maintenant 45 secondes pour passer en mode de détartrage, sinon la machine repasse en mode «Prêt à infuser du café».

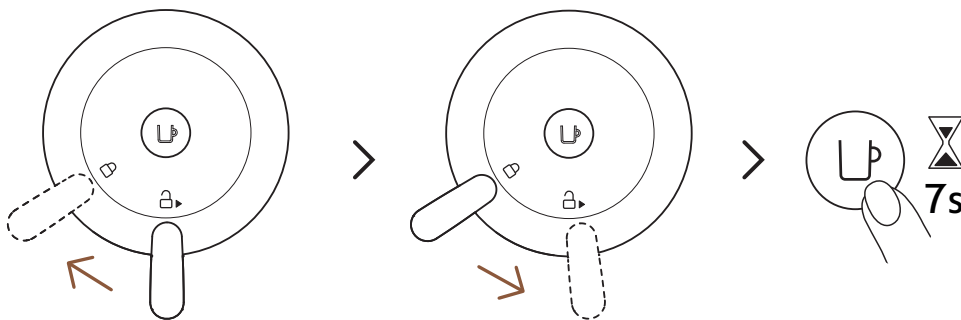

- 6** Verrouillez la tête de la machine en tournant le levier vers la gauche jusqu'au symbole de verrouillage, puis déverrouillez le levier en le tournant vers la droite jusqu'à la position de déverrouillage. Maintenez à nouveau le bouton pendant au moins 7 secondes.

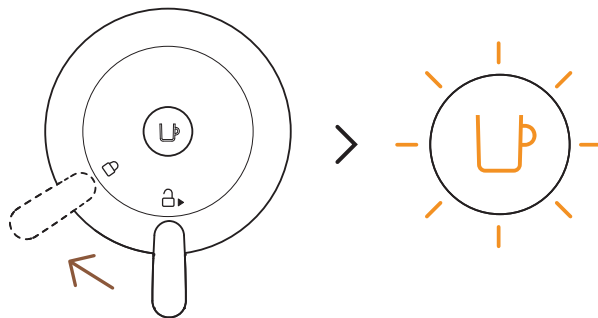

- 7** Pour passer en mode détartrage, verrouillez l'appareil en tournant le levier vers la gauche en position de verrouillage. Le voyant doit encore clignoter rapidement en orange. Cela indique que vous êtes entré en mode détartrage.

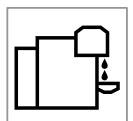
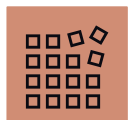

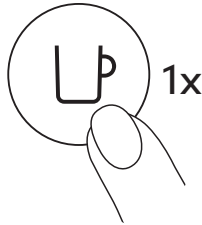

- 8** Appuyez une fois sur le bouton café pour lancer le processus de détartrage. Le voyant clignotera continuellement en orange tout au long du processus.

- i** La machine s'arrête automatiquement lorsque la première phase de détartrage est terminée.

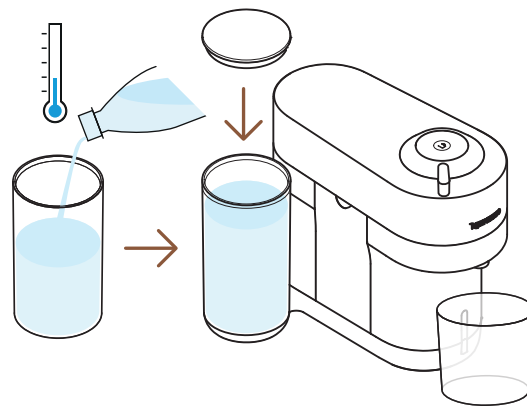

- 9** À la fin du processus de détartrage, il est temps de rincer la machine. Rincez soigneusement le réservoir d'eau et le bac d'égouttage.

Remplissez le réservoir d'eau avec de l'eau potable fraîche et remettez-le en place. Videz le réservoir et remettez-le en place sous la sortie de café.

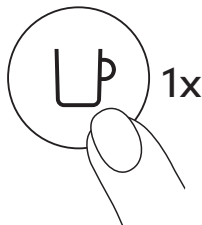

- 10** Appuyez sur le bouton pour rincer la machine. Lorsque le bouton cesse de clignoter rapidement, la procédure de détartrage est terminée.

- i** La machine s'arrête automatiquement lorsque la procédure est terminée.

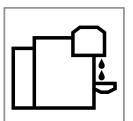
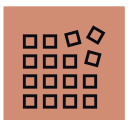

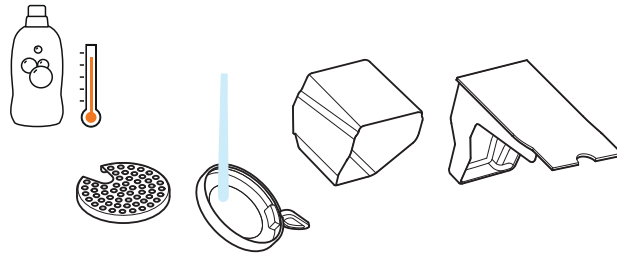

- 11** Lavez le contenant de la capsule, le support de la tasse et le plateau d'égouttage à l'eau chaude et avec un détergent doux et inodore.

ATTENTION: Ne pas utiliser de solvants ou de produits nettoyants puissants ou abrasifs. Ne pas mettre au lave-vaisselle. Ne jamais immerger la machine ou ses pièces dans l'eau.

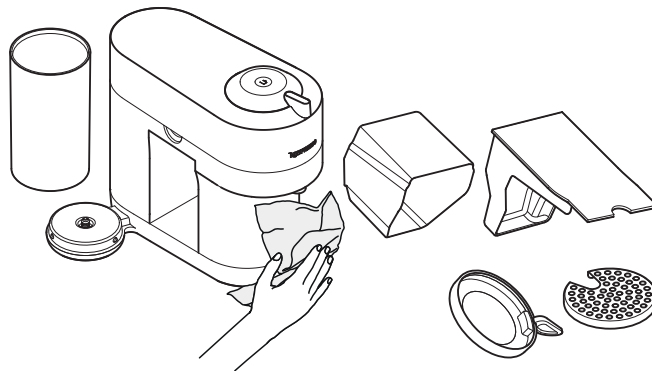

- 12** Séchez la machine avec une serviette propre et fraîche. Laissez sécher la machine pendant 10 minutes avant de l'utiliser.

À NOTER: L'eau peut s'accumuler à l'intérieur de la tête de la machine pendant le nettoyage. Si cela se produit, essuyez les parties visibles avec un chiffon propre et sec.

REMARQUE : la machine ne peut entrer en mode détartrage qu'après avoir préparé au moins 30 cafés.

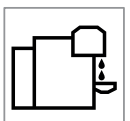
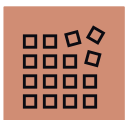

VIDANGE DU SYSTÈME

La vidange du système peut être effectuée avant une période de non-utilisation, pour la protection contre le gel ou avant d'envoyer la machine en réparation.

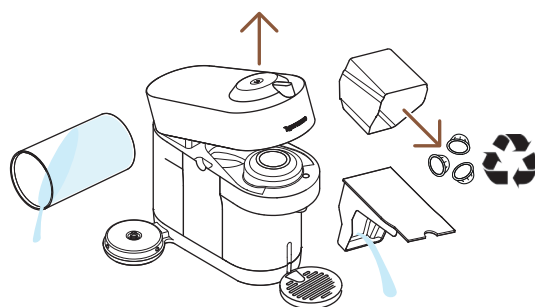

- 1 Videz le réservoir d'eau, ouvrez la tête de la machine et laissez la capsule usagée être éjectée. Videz le récipient à capsules et le bac de récupération. N'oubliez pas de recycler vos capsules **Nespresso**.*

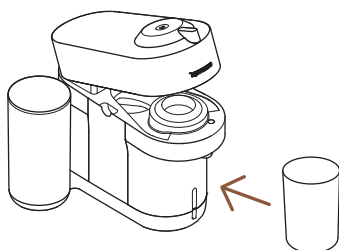

- 2 Remettez-les en place sur la machine, retirez le support de tasse et placez un récipient vide (0,5 L / 17 oz liq) sous la sortie du café.

* C'EST **NESPRESSO**. C'EST RECYCLABLE. Pour plus d'informations sur le recyclage de vos capsules **Nespresso**, visitez le site www.nespresso.com

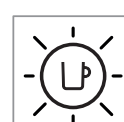
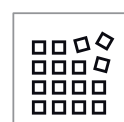
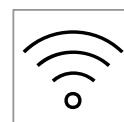
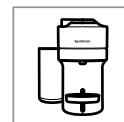

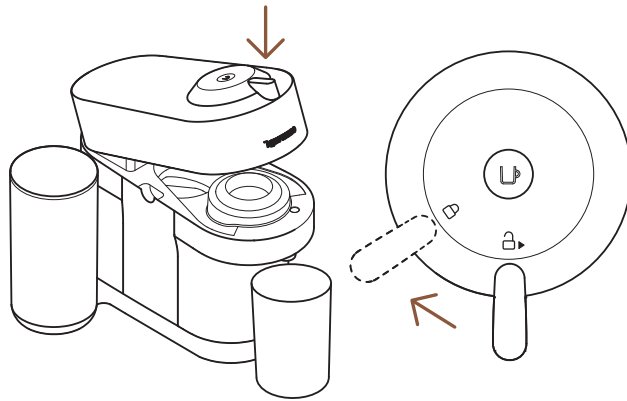

- 3** Avec la machine branchée et en marche, tournez le levier vers la position de verrouillage.

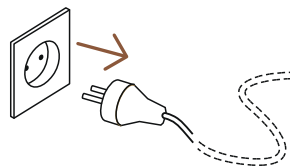

- 4** Débrancher la machine.

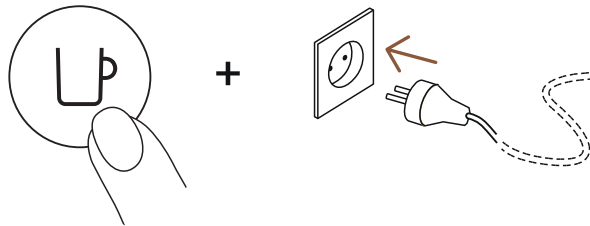

- 5** Appuyez sur le bouton et maintenez-le enfoncé tout en branchant la machine.



- 6** Relâchez le bouton. Il clignotera en orange et le processus de vidange commencera.

- i** Il faut environ 30 secondes à la machine pour effectuer le processus de vidange. La machine s'éteint automatiquement lorsqu'elle est vide.

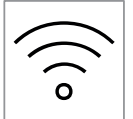

RÉINITIALISER LES RÉGLAGES PAR DÉFAUT

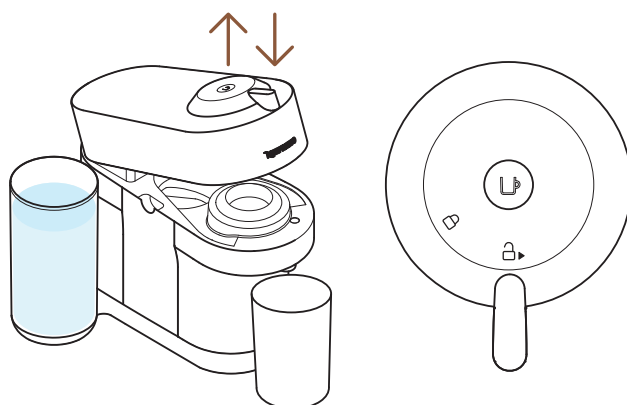

- 1** Lorsque la machine est branchée, ouvrez puis fermez la tête de la machine avant de laisser le levier en position de déverrouillage.

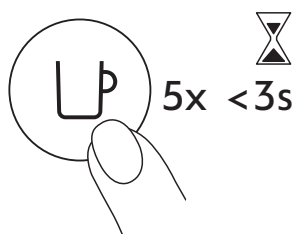

- 2** Appuyer sur le bouton à 5 reprises dans un intervalle de 3 secondes La machine est maintenant programmée avec les réglages d'usine.

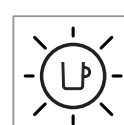
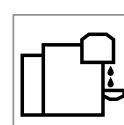
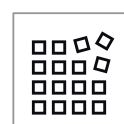
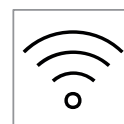
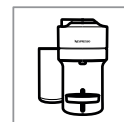

RÉSUMÉ DES CLIGNOTEMENTS

Vous voulez en savoir plus sur les clignotements du Vertuo Pop+ ?
Regardez la vidéo suivante :

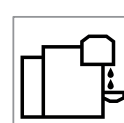
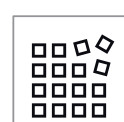
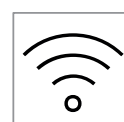

SERVICE DE DÉPANNAGE

Aucun voyant allumé sur le bouton

- La machine s'est éteinte automatiquement ; appuyez sur le bouton ou déverrouillez la machine.
- Vérifiez l'alimentation secteur, la prise, la tension et le fusible.

Le café et l'eau ne s'écoulent pas.

- Vérifiez que le réservoir d'eau est rempli.
- Vérifiez qu'une capsule neuve est correctement insérée et que la poignée est bien verrouillée. Appuyez sur le bouton pour démarrer la préparation du café.
- Procédez au détartrage de la machine si nécessaire
- Ouvrez la partie supérieure de la machine ; la capsule est éjectée automatiquement. Lancez ensuite la procédure de nettoyage conformément aux instructions figurant à la section « Nettoyage » du présent guide

Le café n'est pas assez chaud.

- Préchauffez la tasse avec de l'eau chaude du robinet
- Procédez au détartrage de la machine si nécessaire

Il y a une fuite ou le café s'écoule de façon inhabituelle.

- Vérifiez que le réservoir d'eau est correctement positionné.
- Procédez au détartrage de la machine si nécessaire

La machine s'éteint.

- Dans un souci d'économie d'énergie, la machine s'éteint après 2 minutes de non-utilisation.
- La machine peut être éteinte manuellement à tout moment (lorsqu'elle n'est pas utilisée) en appuyant sur le bouton et en le maintenant enfoncé pendant 3 secondes.

Marc de café dans la tasse.

- Lancez la procédure de nettoyage deux fois de suite
- Consultez la section intitulée « Nettoyage ».

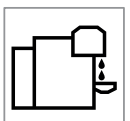

La machine ne fonctionne pas et le voyant « MARCHE » reste allumé. Si le voyant clignote, voir les points suivants

La machine ne fonctionne pas et le voyant clignote de façon intermittente ; un clignotement, puis une pause.

Le voyant clignote pendant que la machine fonctionne.

Le voyant clignote et la machine ne fonctionne pas.

- Vérifier que le levier est correctement verrouillé.
- Si vous voulez préparer un café, vérifiez qu'une capsule neuve est correctement insérée et que le levier est bien verrouillée. Appuyez sur le bouton pour démarrer la préparation du café.
- Si vous souhaitez lancer une procédure de nettoyage, de détartrage ou de vidange, vérifiez que le compartiment à capsules est vide, fermez et verrouillez la machine, puis appuyez sur le bouton pour lancer l'une de ces procédures.
- Remplissez le réservoir d'eau et appuyez sur le bouton.
- Vérifiez que le levier est correctement verrouillé.
- Si le café coule normalement, la machine fonctionne bien.
- Si de l'eau s'écoule uniquement, l'appareil exécute une demande de l'utilisateur concernant le nettoyage, le détartrage ou la vidange du système. Reportez-vous à la section correspondante.
- Éteignez la machine en appuyant sur le bouton pendant 3 secondes, puis appuyez de nouveau dessus pour remettre la machine sous tension. Après une utilisation prolongée, laissez la machine refroidir pendant environ 20 minutes.
- Un temps d'attente est nécessaire avant l'écoulement du café (en raison de la lecture du code-barres et du prémouillage du café).
- Vérifiez qu'une capsule neuve est correctement insérée et que la poignée est bien verrouillée. Appuyez sur le bouton pour démarrer la préparation du café.
- Remplissez le réservoir d'eau et appuyez sur le bouton.
- Éteignez la machine en appuyant sur le bouton pendant 3 secondes, puis appuyez de nouveau dessus pour remettre la machine sous tension. Après une utilisation prolongée, laissez la machine refroidir pendant environ 20 minutes.

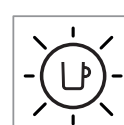
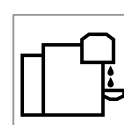
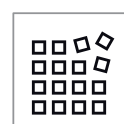
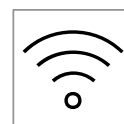
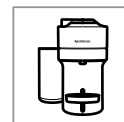

Le voyant clignote de façon intermittente (deux clignotements suivis d'une pause, et ainsi de suite). La machine ne fonctionne pas.

- Pendant la préparation d'un Café:
 - 1) Déverrouillez le levier et ouvrez la partie supérieure de la machine afin de vérifier si une capsule neuve et non endommagée est correctement insérée.
 - 2) Vérifier que le levier est en position "VERROUILLÉE".
 - 3) Vérifiez que le réservoir d'eau est rempli.
- Pendant la procédure de détartrage, de vidange ou de nettoyage:
 - 1) Vérifiez que la capsule a été éjectée.
 - 2) Vérifier que le levier est en position "VERROUILLÉE".
- Pendant la programmation d'une longueur de tasse:
 - 1) Vérifier si une capsule a bien été insérée.
 - 2) Reportez-vous à la section correspondante.
- Si le problème persiste:
 - 1) Déverrouillez le levier et ouvrez la partie supérieure de la machine.
 - 2) Remplacez la capsule (si nécessaire).
 - 3) Débranchez le câble d'alimentation, attendez 10 secondes, puis rebranchez-le.
 - 4) Fermez la machine et appuyez sur le bouton pour la mettre sous tension, puis appuyez de nouveau pour lancer la préparation du café.

Si le problème persiste, appelez **Nespresso**.

Le voyant clignote de façon intermittente à 3 reprises, puis reste allumé.

- Détartrage requis : une fois que l'alerte apparaît, l'utilisateur peut encore préparer quelques cafés avant que le détartrage ne devienne obligatoire

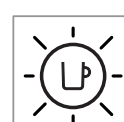
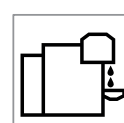
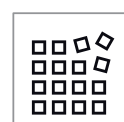
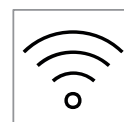
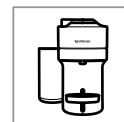

SPÉCIFICATIONS

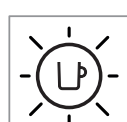
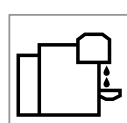
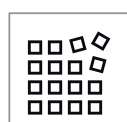
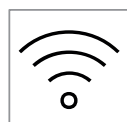
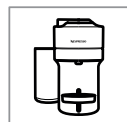

Puissance

~220–240 V, 50–60 Hz, 1300–1500 W

US, CA: 120 V, 60 Hz, 1500 W

MX: 127 V~, 60 Hz, 1650 W

Fréquence

2.402–2.480 GHz

Puissance d'émission (EIRP)

Bluetooth 4 dBm Max. e.i.r.p. et Wi-Fi

<20 dMm max. e.i.r.p.

Veille

0.39 W/h

Mode économie d'énergie

Arrêt automatique: 2 min

Temps de chauffe

30 secondes (tête fermée et verrouillée)

Support de tasse mobile pour les grandes recettes

Oui, 2 positions

Longueur du câble à partir de la sortie du dispositif

90 cm / 35.4 po

Dimensions (L x P x H)

22 x 35.6 x 26.5 cm / 8.6 x 14 x 10.4 in

Poids

Vertuo Pop+: 3.6 kg / 7.9 lbs

Vertuo Pop+ Deluxe: 3.7 kg / 8.1 lbs

Capacité du réservoir d'eau

Vertuo Pop+: 750 ml / 25.4 fl oz

Vertuo Pop+ Deluxe: 1.1 L / 37.2 fl oz

Capacité du conteneur à capsules

8 capsules espresso ou 5 capsules pour tasse

CODES DE LA MACHINE

Nespresso

GCV6 GDV6

Breville

BNV520, BNV550,
BNV530, BNV560,
BNV540, BNV570

Delonghi

ENV92B, ENV92BAE,
ENV92Y, ENV92YAE,
ENV92AAE, ENV95S,
ENV95SAE

CLIC Y ELIJA SU LENGUAJE

ES



PRECAUCIONES DE SEGURIDAD



VISIÓN GENERAL



CONECTIVIDAD



PRIMER USO



PREPARACIÓN DE CAFÉ



AJUSTE EL VOLUMEN DE CAFÉ



LIMPIEZA



DESCALCIFICACIÓN



VACIADO DEL SISTEMA



RESETEAR LOS VALORES DE FÁBRICA



RESUMEN DEL PARPADEO



SOLUCIÓN DE PROBLEMAS



ESPECIFICACIONES

INDICACIONES DE SEGURIDAD

PRECAUCIÓN: Antes de operar su aparato, favor de referirse a las indicaciones de seguridad para evitar posibles daños o lesiones.

DESECHO Y PROTECCIÓN DEL AMBIENTE

Este aparato está en cumplimiento con lo estipulado por la EU 2012/19/EC. Los materiales de empaque y el aparato contienen piezas que pueden ser recicladas. Su aparato cuenta con piezas valiosas que pueden ser recuperadas o recicladas. La separación de los materiales en diferentes tipos facilita su reciclaje. Deje el aparato en un punto de recolección. Puede obtener información sobre el desecho con las autoridades locales.

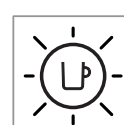
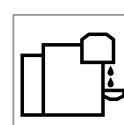
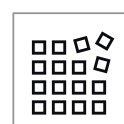
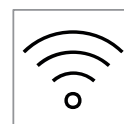
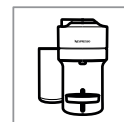

VISIÓN GENERAL DE LA MÁQUINA

VISIÓN GENERAL DE LA MÁQUINA

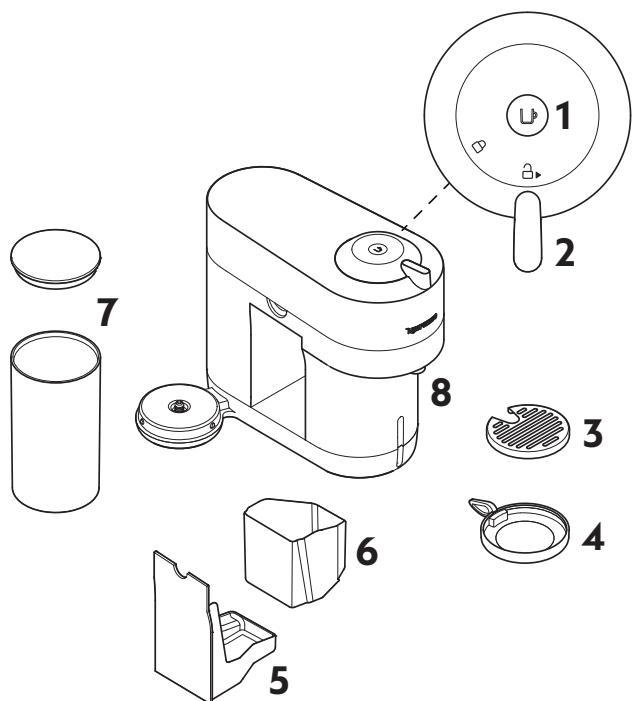

- 1 Botón ON/OFF y de café
- 2 Palanca de bloqueo/desbloqueo
- 3 Rejilla de goteo
- 4 Soporte para tazas ajustable
- 5 Bandeja de goteo
- 6 Contenedor de cápsulas usadas
- 7 Tanque de agua y tapa
- 8 Salida de café

CONTENIDO DEL EMPAQUE



- 1 Máquina de café
- 2 Set de cápsulas de degustación
- 3 Paquete de bienvenida a **Nespresso**
- 4 Instrucciones de seguridad
- 5 Guía de inicio rápido
- 6 Garantía

i Desembalaje: Un poco de polvo puede estar presente en la superficie de la máquina debido a los materiales reciclados que son utilizados para elaborar el embalaje. Esto no representa un riesgo, solo debe limpiar la máquina con un paño suave

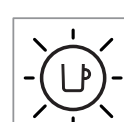
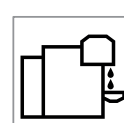
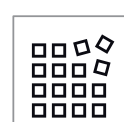
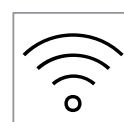
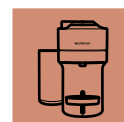

ABRIR/CERRAR

ABRIR

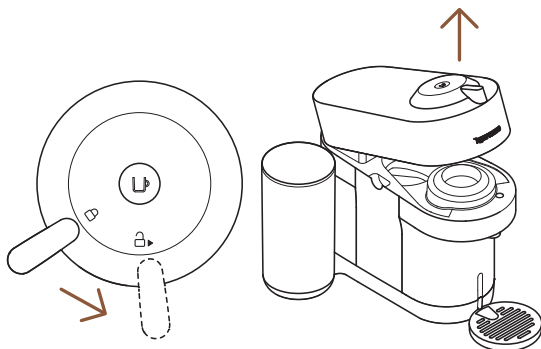

CERRAR

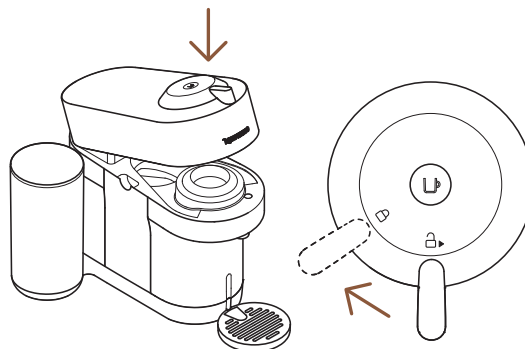

PRECAUCIÓN: Para el uso adecuado de la máquina, no abra el cabezal de la máquina durante la preparación del café, espere hasta que la luz del botón de café vuelva a estar fija en blanco. Si desea detener la preparación antes; presione una vez el botón de café y espere hasta que la máquina se detenga antes de abrir el cabezal de la máquina.

EL SISTEMA VERTUO

CÁPSULAS COMPATIBLES



S

Ristretto
(25 ml)

Espresso
(40 ml)



M

Double Espresso
(80 ml)

Gran Lungo
(150 ml)



L

Mug
(230 ml)



XL

Alto, Cold Brew Style
(355 ml)

Carafe
(535 ml)

ACCESORIOS COMPATIBLES



Accesorios
compatibles



Ristretto



Espresso



**Double
Espresso**



**Gran
Lungo**



Mug (S)



Mug (M)



**Vaso
Reveal**



Accesorios no
compatibles



Mug (L)



Carafe

Descubra nuestra colección completa de accesorios en:

www.nespresso.com

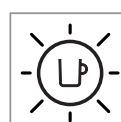
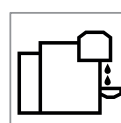
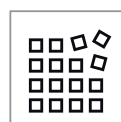
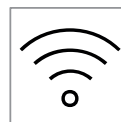
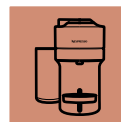

ENCENDIDO/APAGADO

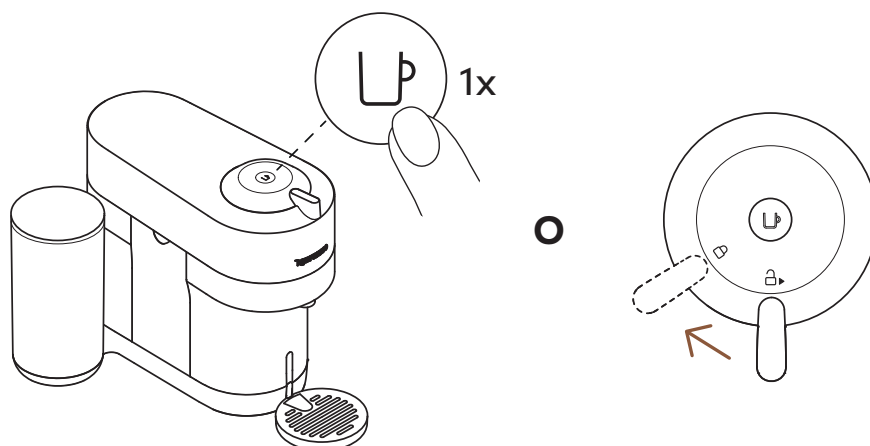
**ENCENDIDO**

Una vez que la máquina esté conectada, presione el botón una vez o mediante el cierre de la palanca en la posición de bloqueo (con el cabezal cerrado).

- i** La luz parpadeará por aproximadamente 30 segundos mientras la máquina está en calentamiento. Una vez que la luz esté fija, la máquina está lista para su uso.

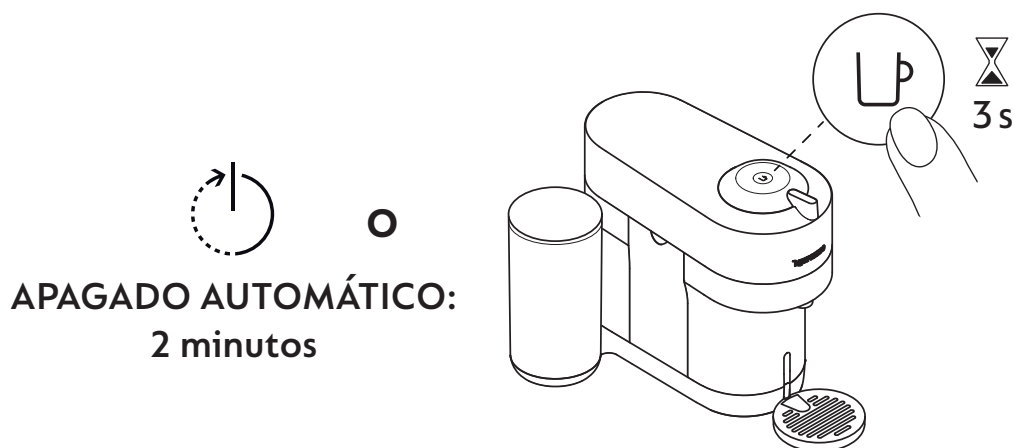
**APAGADO**

Para ahorrar energía, la máquina se apagará después de 2 minutos sin uso.

- i** La máquina puede apagarse de manera manual en cualquier momento (cuando no esté en uso) al mantener presionado el botón por 3 segundos.

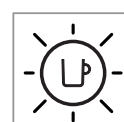
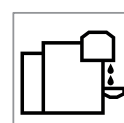
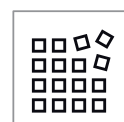
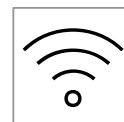
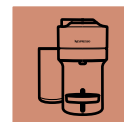

CONECTIVIDAD

¿POR QUÉ DEBERÍA CONECTAR SU MÁQUINA VERTUO POP+?

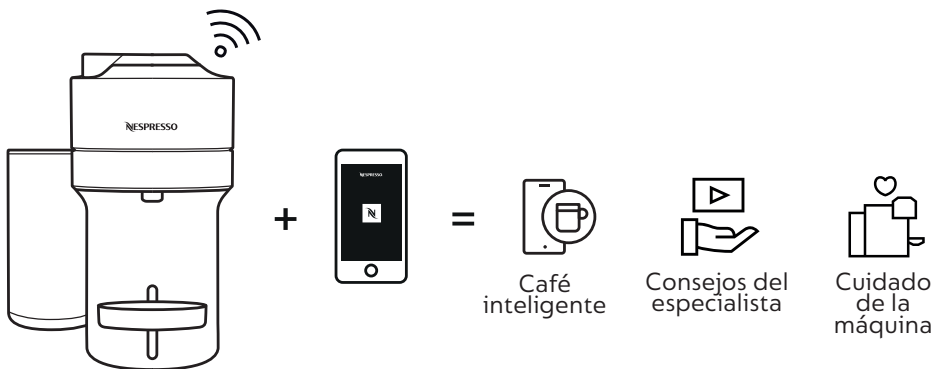

BENEFICIOS DE CONECTAR SU MÁQUINA VERTUO POP+

- **Café inteligente:** Manténgase siempre un paso por delante para obtener lo último en nuestras innovaciones de café de **Nespresso** manteniendo su máquina al día.
- **Consejos del especialista:** Obtenga soporte y video tutoriales simples para acompañar su viaje de café a través de su smartphone.
- **Cuidado de la máquina:** Reciba una notificación instantánea sobre cómo y cuándo realizar el mantenimiento de su máquina con una guía de paso a paso sobre descalcificación, enjuague y limpieza.

¿CÓMO CONECTAR SU MÁQUINA VERTUO POP+?

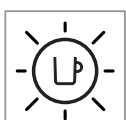
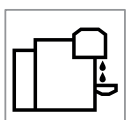
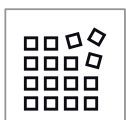

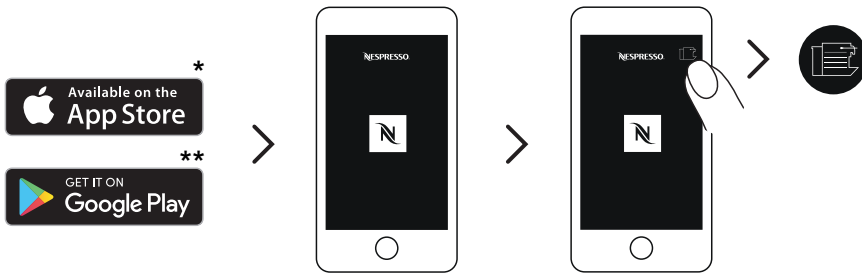

1 Descargue o actualice la App de **Nespresso**. Ejecute la App de **Nespresso** en su smartphone o su tableta. Presione el botón de máquina en la parte superior derecha de su pantalla.

NOTA: Para un óptimo funcionamiento y una experiencia perfecta, se recomienda conectar su máquina a un enrutador Wi-Fi en lugar de usar un punto de acceso de smartphone.

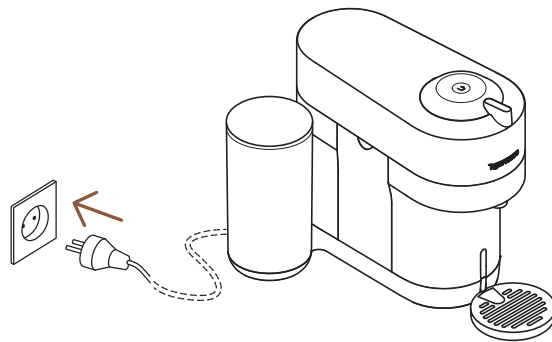

2 Conecte el cable de alimentación eléctrica.

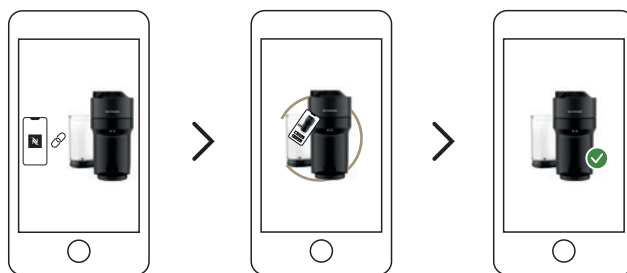

3 Siga las instrucciones mediante la App de **Nespresso**.

PRECAUCIÓN: Primero lea las indicaciones de seguridad para evitar riesgos fatales o shock eléctrico e incendios. Asegure la conexión a tierra al conectar la máquina a la luz eléctrica.

* AppStore® es una marca registrada de Apple Inc., y registrada en EUA y otros países.
 ** Google Play y el logo de Google Play son marcas registradas de Google LLC.

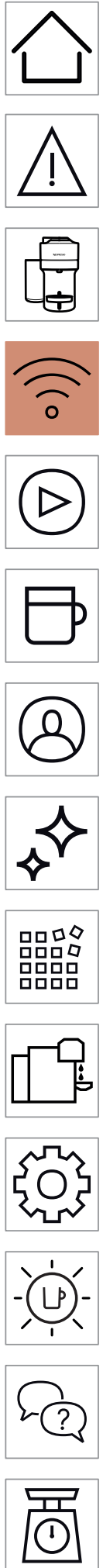

DESACTIVAR EL BLUETOOTH Y WIFI DE LA MÁQUINA

La máquina cuenta con un módulo de conectividad que está encendido por default. Brinda opciones adicionales, mejorando su experiencia de café. Para desconectar el módulo de conectividad, siga los siguientes pasos:

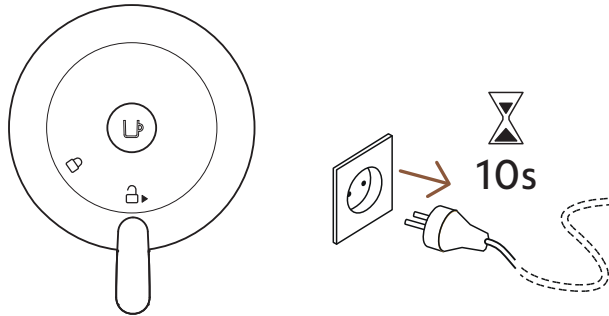

- 1 Con el cabezal de la máquina cerrado y la palanca en la **posición de desbloqueo**, desconecte la máquina por al menos 10 segundos.

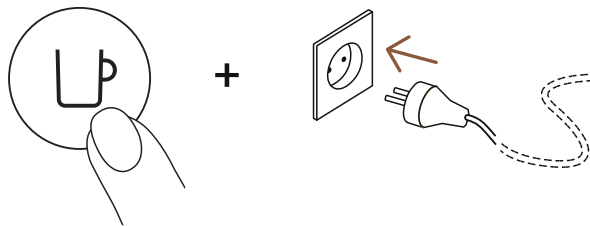

- 2 Mantenga presionado el botón mientras vuelve a conectar la máquina.
El botón parpadeará en color naranja para confirmar que el módulo de conectividad está desactivado.

- i** Siga los mismos pasos para encender de nuevo el módulo de conectividad. El botón parpadeará en color blanco para confirmar que se ha reactivado el módulo.



PRIMER USO

PRIMER ENJUAGUE

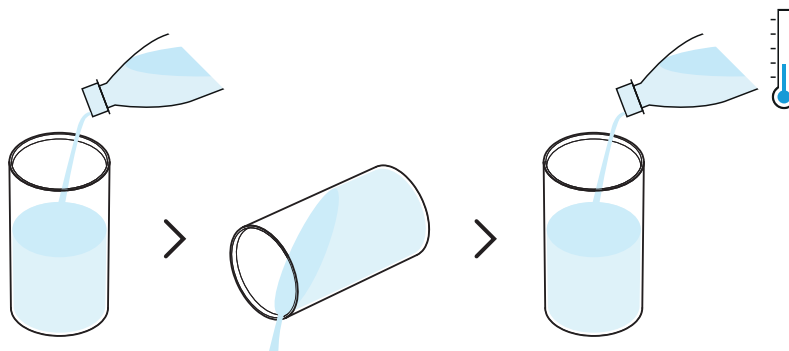

- 1** Primero enjuague y limpie el tanque de agua y la tapa antes de llenarlo con agua potable fresca.

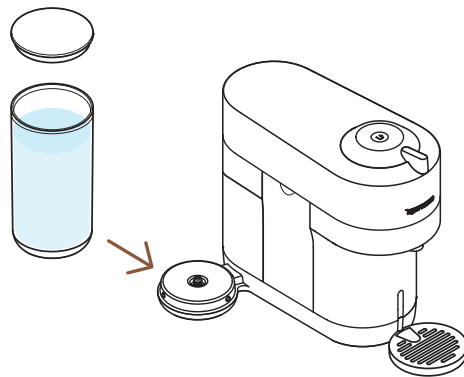

- 2** Cierre el tanque de agua con la tapa y coloque el tanque de agua en su lugar. Asegúrese de que esté bien sujeto.

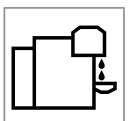
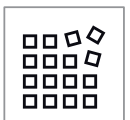

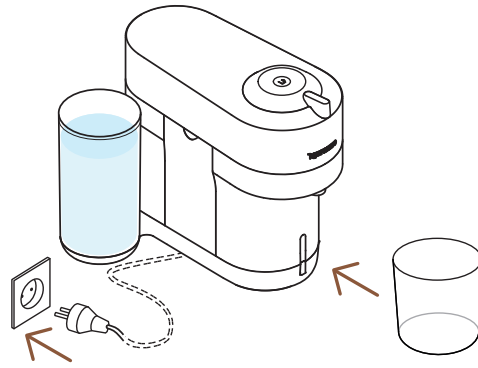

- 3** Conecte el cable de alimentación eléctrica, retire el soporte de tazas y coloque un contenedor vacío (de al menos 1 L) debajo de la salida de café.

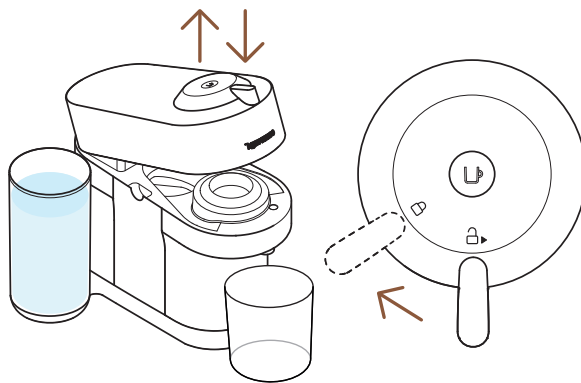

- 4** Abra y cierre la máquina. Asegure que la palanca está en la posición de bloqueo.

- i** La luz parpadeará mientras la máquina está en calentamiento. Tomará aproximadamente 30 segundos. Cuando la luz se mantenga fija la máquina estará lista. Asegúrese de que no exista ninguna cápsula insertada.

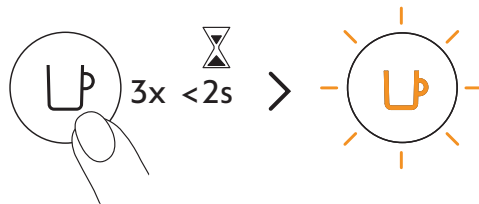

- 5** Presione el botón 3 veces en un periodo de 2 segundos. Con la luz naranja intermitente, deje que el proceso de enjuague se complete automáticamente. Cuando la luz se mantenga blanca, el ciclo estará completo.

- i** Debe de tomar menos de 2 minutos antes de que comience el proceso de enjuague y el agua comience a fluir. Este proceso puede tomar hasta 7 minutos.

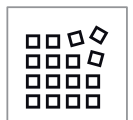

PREPARACIÓN DE CAFÉ

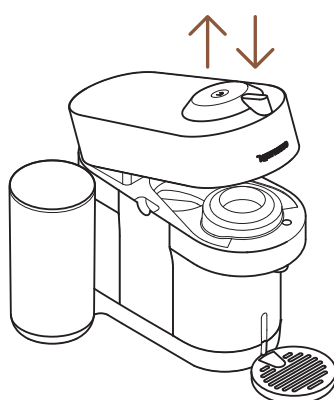

1 Abrir y cerrar la máquina.

i La luz del botón de café parpadeará mientras la máquina esté en calentamiento. Cuando la luz se vuelva fija, la máquina estará lista para usarse.

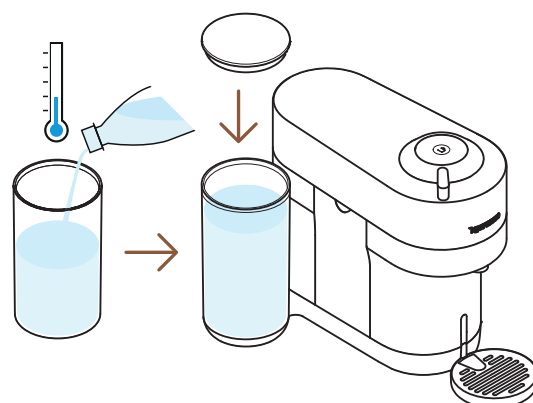

2 Llenar el tanque de agua con agua fresca potable y colocarlo de nuevo en su posición.

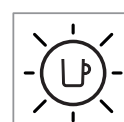
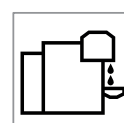
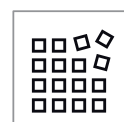
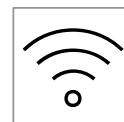
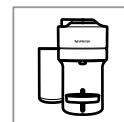

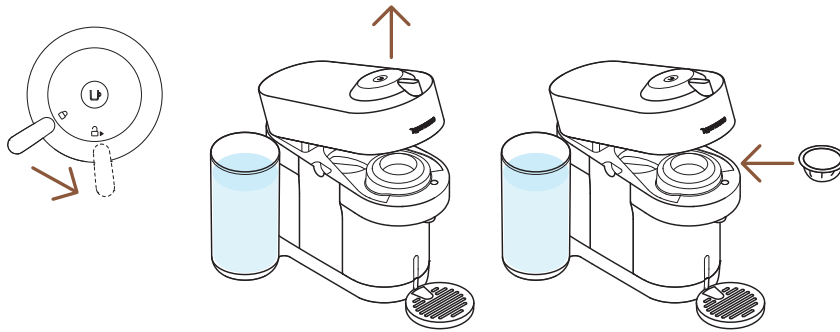

- 3** Desbloquee y abra el cabezal de la máquina por completo e inserte una cápsula Vertuo con la forma de domo hacia abajo.

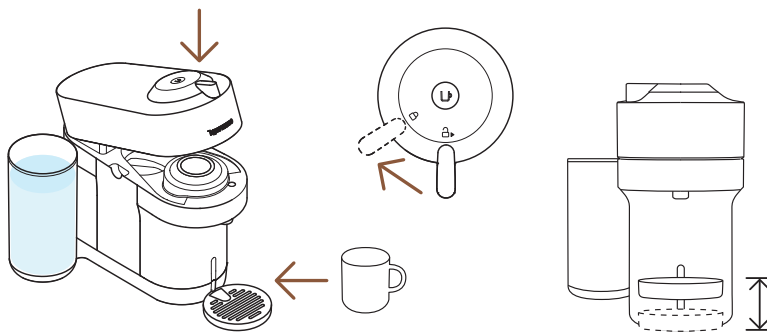

- 4** Cierre el cabezal de la máquina y bloquee el sistema girando la palanca hacia la izquierda hasta la posición de bloqueo y coloque una taza. El soporte de tazas puede ajustarse para acomodar su tamaño de taza.

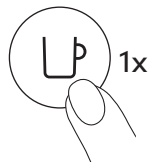

- 5** Inicie la extracción al presionar el botón una vez.

PRECAUCIÓN: Para el uso adecuado de la máquina, no abra el cabezal de la máquina durante la preparación del café, espere hasta que la luz del botón de café vuelva a estar fija en blanco. Si desea detener la preparación antes; presione una vez el botón de café y espere hasta que la máquina se detenga antes de abrir el cabezal de la máquina.

- i** Debido a la lectura del código, el prehumedecimiento del café y el tiempo de la infusión, pasará un momento antes de que el café comience a fluir. La máquina reconocerá automáticamente la cápsula insertada y seleccionará los parámetros de preparación del café y la longitud de la taza definidos por los expertos en café de **Nespresso** para extraer las mejores mezclas de café.

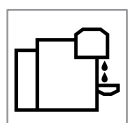

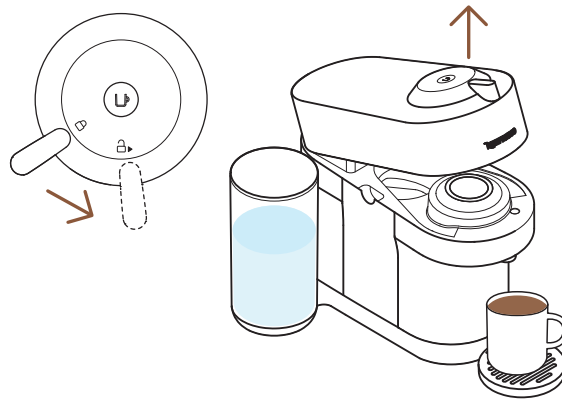

- 6** Cuando se finalice la preparación del café, abra el cabezal de la máquina girando la palanca hacia la derecha, hacia la posición de desbloqueo para expulsar automáticamente la cápsula y disfrute su café.



- 7** No olvide reciclar sus cápsulas **Nespresso**.*

* ESTO ES **NESPRESSO**, ES RECICLABLE. Para más información de nuestro programa de reciclaje, visite www.nespresso.com

DESCUBRA NUESTRO MODO COFFEE CREATIONS.



Con esta máquina, **Nespresso** le ofrece una función específica para concentrar su extracción de café para crear sus propias recetas.



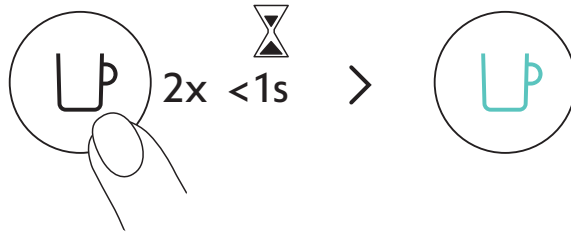

Con su máquina encendida, haga doble clic en el botón de café. Parpadeará color turquesa y la preparación de su café se concentrará, optimizando el sabor del café en recetas con complementos (leche, crema, sobre hielo...). Para una experiencia de café incomparable.

40 ml	80 ml	150 ml	230 ml	355 ml	535 ml
✓	✓	✓	✓	✗	✗
25 ml	40 ml	40 ml	80 ml		

Para disfrutar por completo los beneficios, recomendamos preparar nuestra gama de Coffee+ utilizando solo los tamaños oficiales de taza. Para obtener los mejores resultados en la taza, no recomendamos preparar nuestro XL (Alto Ambrato, Alto Onice), Cold Brew y Carafe Pour Over Style con este modo.

NOTA: Puede ser necesaria una actualización de su máquina a través de la aplicación de **Nespresso** para habilitar este modo.



Descubre cómo mejorar tu máquina con nuestros Aeroccinos en www.nespresso.com

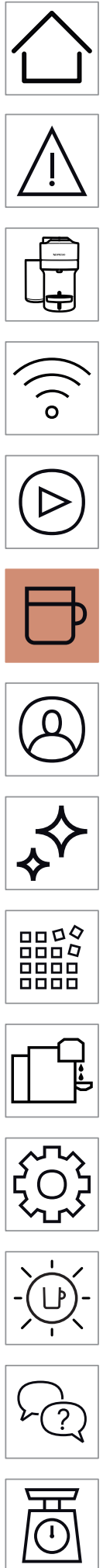

AJUSTE EL VOLUMEN DE CAFÉ

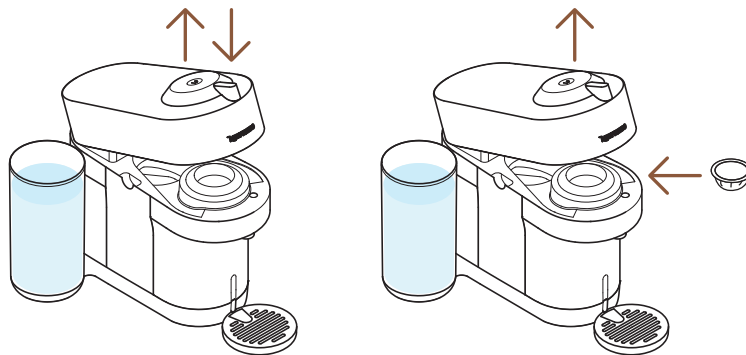

- 1** Abra y cierre la máquina. Con la máquina encendida, abra la máquina e inserte la cápsula que quiera programar.

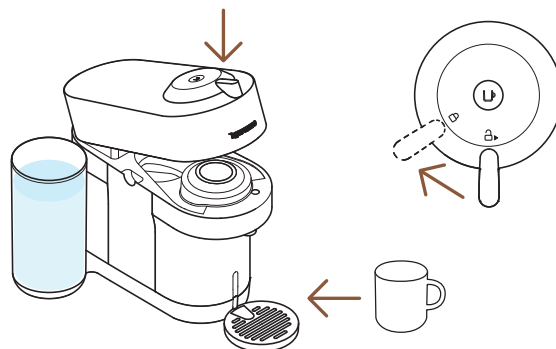

- 2** Cierre el cabezal de la máquina, gire la palanca a la izquierda hacia la posición de bloqueo y coloque una taza.



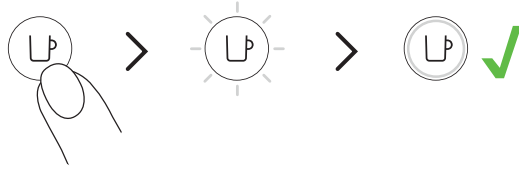

3 Mantenga presionado el botón hasta que alcance el volumen deseado. El volumen de agua ha sido programado para el tipo de cápsula usada durante el ajuste.

i La programación es específica para cada tipo de cápsula. Los tamaños de taza pueden ser programados desde 20 ml hasta 535 ml.

PRECAUCIÓN: Para el uso adecuado de la máquina, no abra el cabezal de la máquina durante la preparación del café, espere hasta que la luz del botón de café vuelva a estar fija en blanco. Si desea detener la preparación antes; presione una vez el botón de café y espere hasta que la máquina se detenga antes de abrir el cabezal de la máquina.

NOTA: Una vez que se programa el volumen deseado por el usuario, cada vez que ese tipo de cápsula sea colocada en la máquina, la preparación parará en el volumen programado por el usuario. Si desea restaurar los valores de fábrica, vea la sección **“Restablecer los valores de fábrica”**.



LIMPIEZA

Limpié su máquina mensualmente, cuando perciba residuos de café dentro del cabezal o después de un periodo largo sin uso.

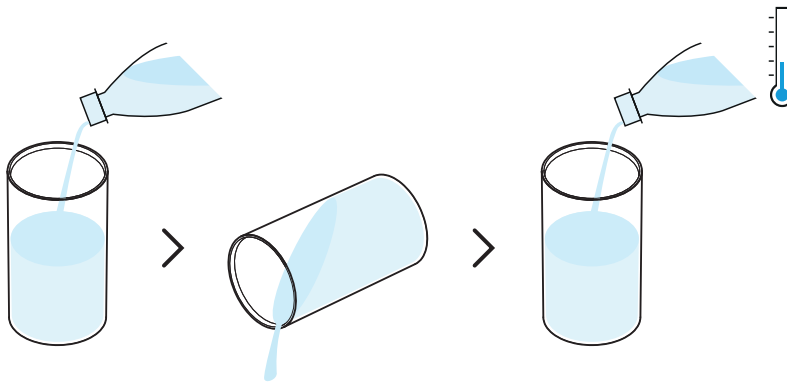

- 1** Enjuague y limpie el tanque de agua y la tapa antes de llenarlo con agua potable fresca.

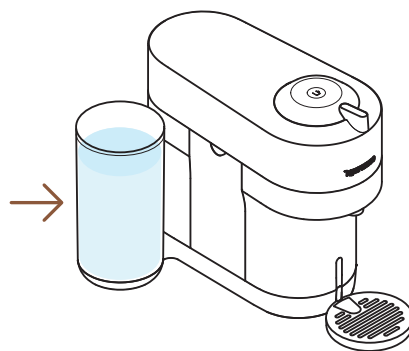

- 2** Coloque el tanque de agua de nuevo en la posición de la máquina.



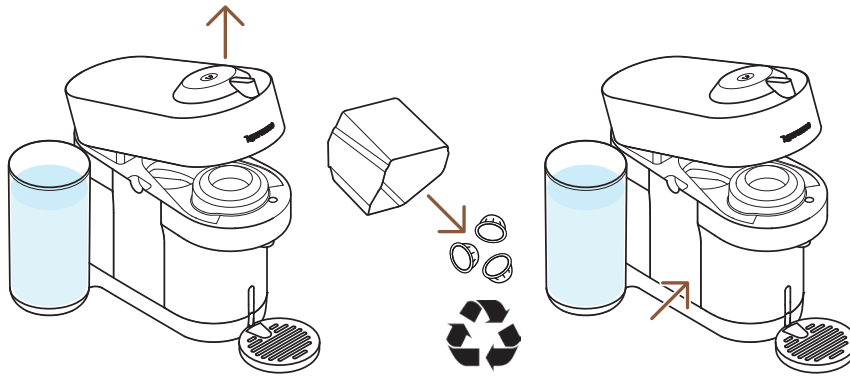

- 3** Con la máquina encendida, desbloquee, abra la máquina y deje que la cápsula usada sea expulsada. Vacíe y enjuague el contenedor de cápsulas y la bandeja de goteo y colóquelas de nuevo en su lugar. No olvide reciclar sus cápsulas **Nespresso**.*

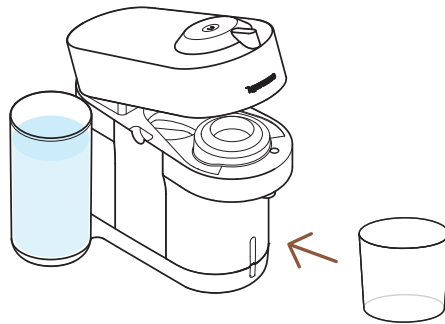

- 4** Retire el soporte de tazas y coloque un contenedor de al menos 1 L de capacidad debajo de la salida de café.

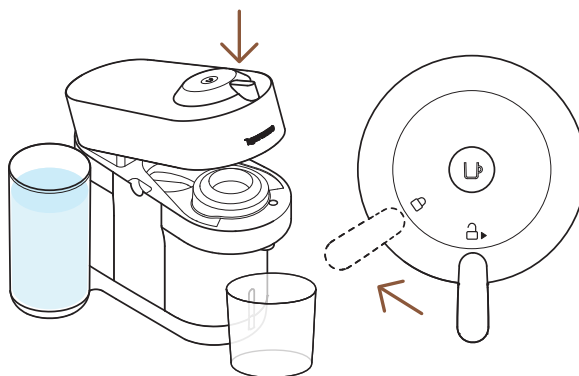

- 5** Cierre el cabezal de la máquina, gire la palanca a la izquierda hacia la posición de bloqueo y coloque una taza. Asegúrese de que no existan cápsulas en la máquina antes de iniciar el proceso de enjuague.

* ESTO ES **NESPRESSO**, ES RECICLABLE. Para más información de nuestro programa de reciclaje, visite www.nespresso.com

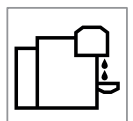
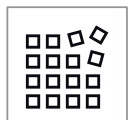

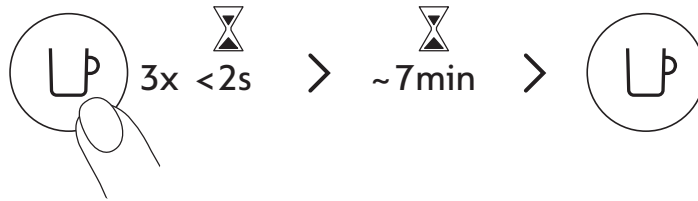

6 Presione el botón 3 veces en un periodo de 2 segundos. Con la luz parpadeando en color naranja, deje que el proceso de enjuague se complete automáticamente.

i Deberá de tomar menos de 2 minutos antes que comience el proceso de enjuague y el agua comience a fluir. Esta operación puede tardar hasta 7 minutos y se detendrá automáticamente cuando se complete el ciclo. El proceso se puede detener en cualquier momento al presionar el botón.

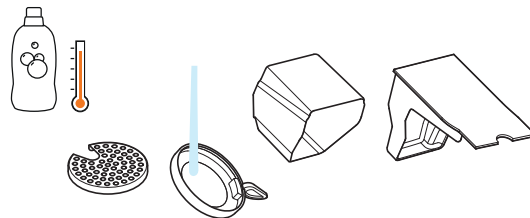

7 Lave el contenedor de cápsulas, el soporte de tazas y la charola de goteo con agua caliente y detergente sin aroma.

PRECAUCIÓN: No utilice agentes de limpieza abrasivos. No coloque la máquina en el lavavajillas. No sumerja el aparato o parte de él en agua.

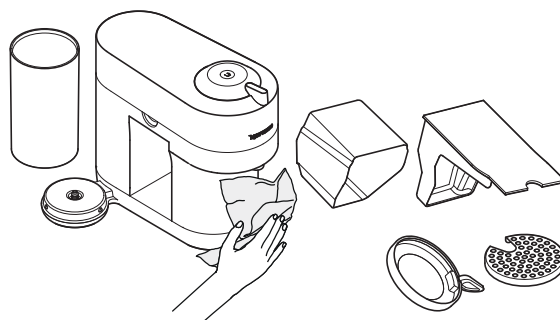

8 Seque con un paño limpio y seco

PRECAUCIÓN: Limpie la salida de café de forma regular con un paño húmedo y limpio. Siempre use paños suaves para limpiar la máquina.

NOTA: Se puede acumular agua dentro del cabezal durante el proceso de limpieza. Si esto pasa, seque las partes visibles con un paño limpio.

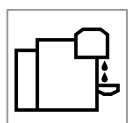

DESCALCIFICACIÓN

El proceso de descalcificación asegura que su máquina funcione apropiadamente durante su tiempo de vida y hará que su experiencia de café sea como el primer día. Su máquina le indicará cuando deba descalcificarla mediante el parpadeo de las luces en color naranja antes de la luz fija blanca.



- i** El proceso de descalcificación toma aproximadamente 20 minutos y **no puede interrumpirse.**

NOTA: Por favor lea con cuidado las instrucciones de descalcificación antes de empezar.

Necesitará:

- El kit de descalcificación disponible en www.nespresso.com
- Un contenedor vacío de al menos 1 L de capacidad

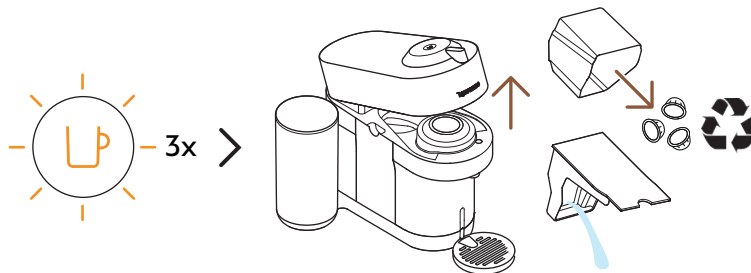

- 1** Con el botón parpadeando en naranja 3 veces: Desbloquee y abra el cabezal de la máquina y deje que la cápsula usada sea expulsada. Vacíe el contenedor de cápsulas y la charola de goteo y colóquelas nuevamente en su lugar. No olvide reciclar sus cápsulas **Nespresso**.*

* ESTO ES **NESPRESSO**, ES RECICLABLE. Para más información de nuestro programa de reciclaje, visite www.nespresso.com

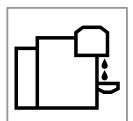

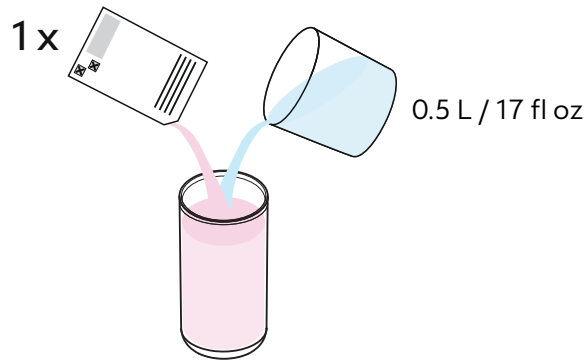

- 2** Llene el tanque de agua con 0,5 L de agua y añada 1 unidad del **líquido** descalcificante de Nespresso.

PRECAUCIÓN: La solución descalcificante puede ser dañina. Evite el contacto con los ojos, la piel y las superficies.

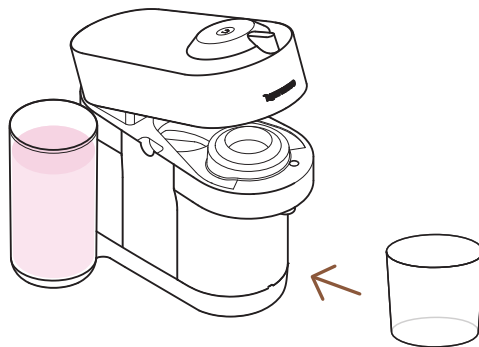

- 3** Retire el soporte de tazas y coloque un contenedor vacío de al menos 1 L de capacidad debajo de la salida de café.

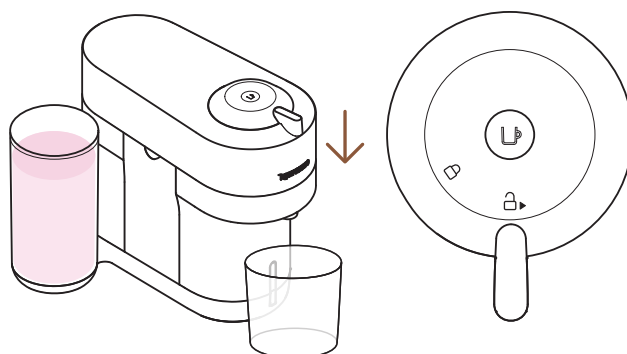

- 4** Con la máquina encendida, cierre el cabezal y mantenga la palanca en la posición de desbloqueo.

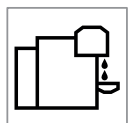
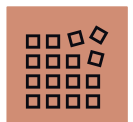

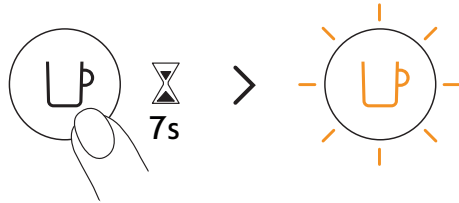

- 5** Mantenga presionado el botón durante al menos 7 segundos o hasta que vea que la luz se apague. El botón empezará a parpadear color naranja rápidamente.

PRECAUCIÓN: Cuenta con 45 segundos para entrar al modo de descalcificación, de lo contrario, la máquina regresará al modo de extracción.

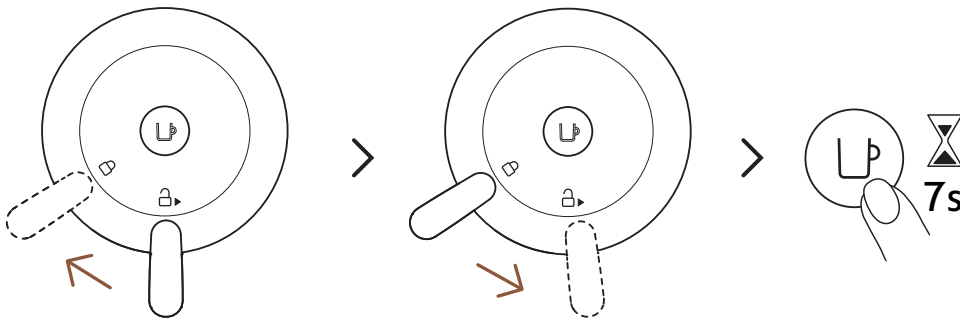

- 6** Bloquea el cabezal de la máquina girando la palanca hacia la izquierda hasta el símbolo de bloqueo y luego desbloquea la palanca girando hacia la derecha hasta la posición de desbloqueo. Mantenga el botón presionado por al menos 7 segundos.

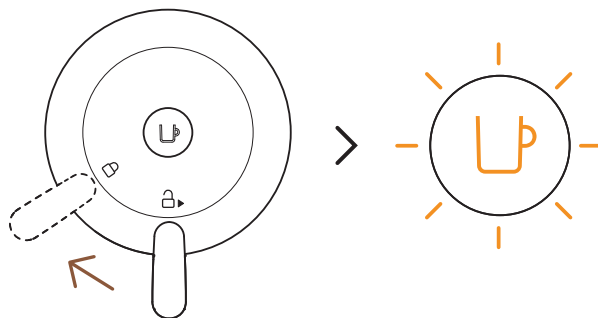

- 7** Para iniciar el modo de descalcificación, bloquee la máquina girando la palanca hacia la izquierda hasta la posición de bloqueo. La luz deberá seguir parpadeando de color naranja de forma rápida. Esta es una indicación de que se ha iniciado el modo de descalcificación.

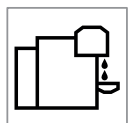
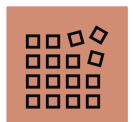

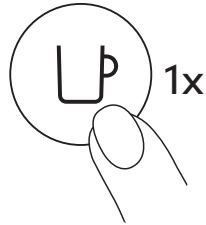

- 8** Presione el botón una vez para iniciar el proceso de descalcificación. La luz continuará parpadeando de forma constante de color naranja durante el proceso.

- i** La máquina se detendrá automáticamente cuando el proceso esté completo.

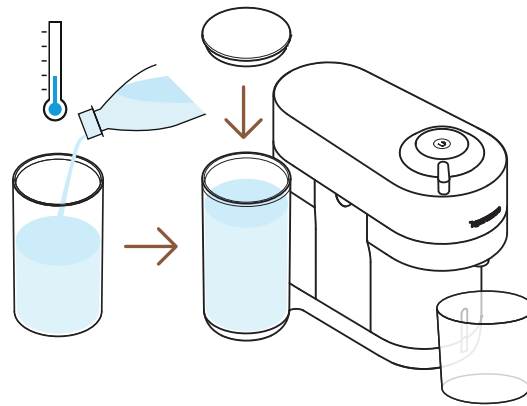

- 9** Al final del proceso de descalcificación, es momento de enjuagar la máquina. Enjuague bien el tanque de agua y la bandeja de goteo.

Llene el tanque de agua con agua fresca potable y colóquelo en su lugar. Vacíe el contenedor y colóquelo en su lugar debajo de la salida de café.

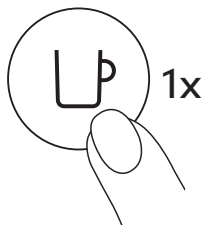

- 10** Presione el botón para enjuagar la máquina. Cuando el botón parpadee rápidamente, el proceso de descalcificación está completo.

- i** La máquina se detendrá automáticamente cuando el proceso esté completo.

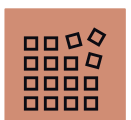

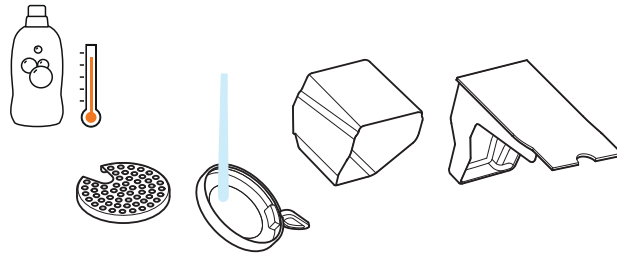

- 11** Lave el contenedor de cápsulas, el soporte de tazas y la charola de goteo con agua caliente y detergente sin aroma.

PRECAUCIÓN: No utilice agentes de limpieza abrasivos. No coloque la máquina en el lavavajillas. No sumerja el aparato o parte de él en agua.

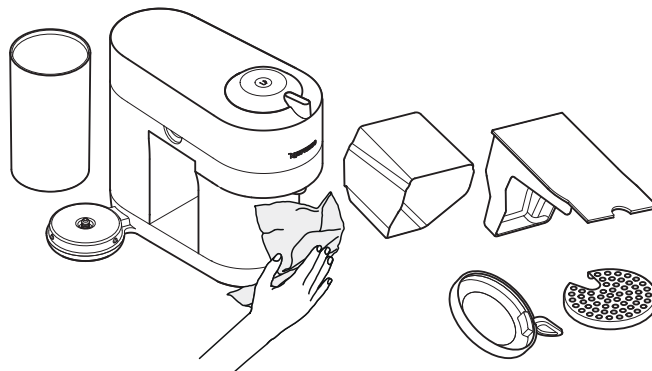

- 12** Seque la máquina con un paño limpio. Deje que la máquina se seque durante 10 minutos antes de usarla.

NOTA: Se puede acumular agua dentro del cabezal durante la limpieza, si esto pasa, seque las partes visibles con un paño limpio y seco.

NOTA: La máquina solo puede entrar en modo de descalcificación después de que se hayan preparado 30 cafés o más.

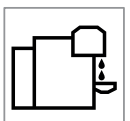
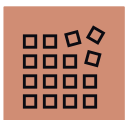

VACIADO DEL SISTEMA

El vaciado del sistema es un proceso que puede ser realizado antes de un periodo sin uso, para protección contra las heladas o previo al envío de la máquina a servicio técnico.

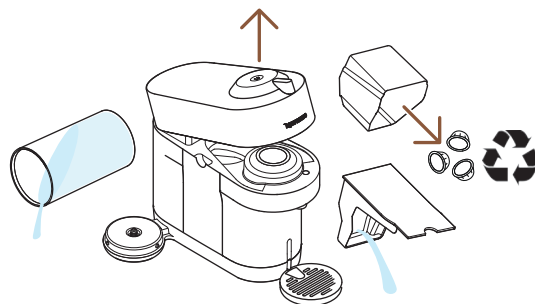

- 1** Vacíe el tanque de agua, abra el cabezal de la máquina y retire la cápsula usada. Vacíe el contenedor de cápsulas y la charola de goteo. No olvide reciclar sus cápsulas **Nespresso**.*

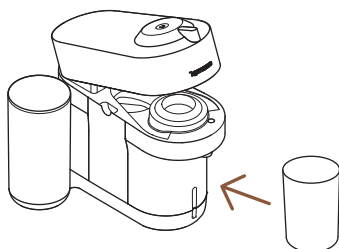

- 2** Coloque los removibles de nuevo en su lugar y retire el soporte de tazas y coloque un contenedor vacío de al menos 0,5 L de capacidad debajo de la salida de café.

* ESTO ES **NESPRESSO**, ES RECICLABLE. Para más información de nuestro programa de reciclaje, visite www.nespresso.com

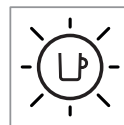
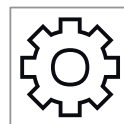
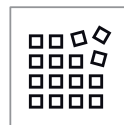
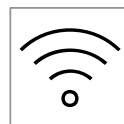
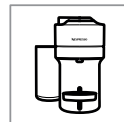

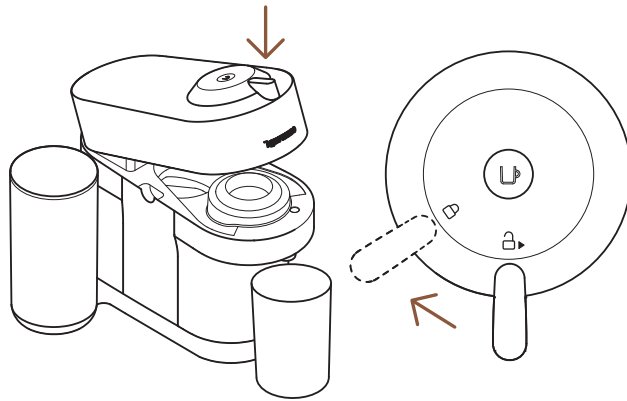

- 3** Con la máquina conectada, cierre el cabezal y coloque la palanca en la posición de bloqueo.

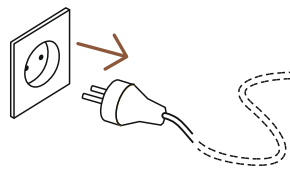

- 4** Desconecte la máquina

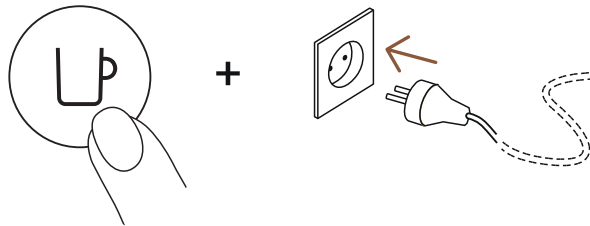

- 5** Mantenga presionado el botón mientras vuelve a conectar la máquina.

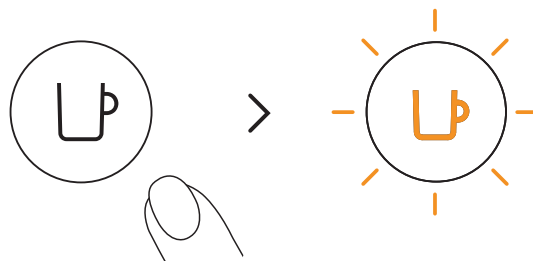

- 6** Deje de presionar el botón. Parpaderá en color naranja y se iniciará el proceso.

- i** Tomará aproximadamente 30 segundos para completar el proceso. La máquina se apaga automáticamente cuando el proceso está terminado.

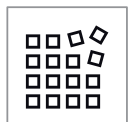

RESETEO EN LOS AJUSTES DE FÁBRICA

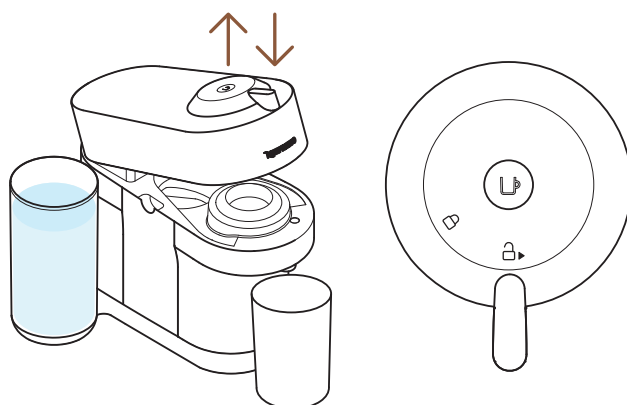

- 1 Con la máquina conectada, cierre el cabezal antes de colocar la palanca en la **posición de bloqueo**.

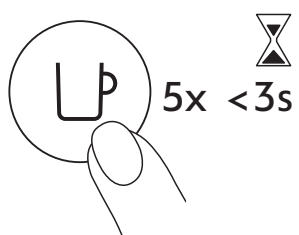

- 2 Presione el botón 5 veces en 3 segundos. La máquina ahora cuenta con los ajustes de fábrica.

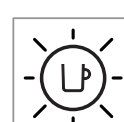
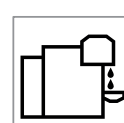
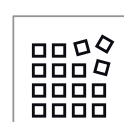
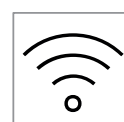

RESUMEN DEL PARPADO

¿Desea saber más sobre el parpadeo de Vertuo Pop+?
Lo invitamos a ver el siguiente video:

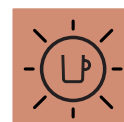
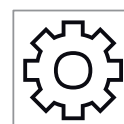
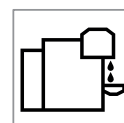
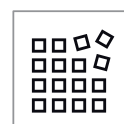
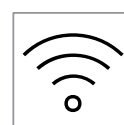

SOLUCIÓN DE PROBLEMAS

No hay luz en el botón

- La máquina se ha apagado automáticamente; presione el botón o desbloquee la máquina.
- Revise el enchufe, voltaje y fusibles.

No extrae café ni agua.

- Revise que el tanque de agua esté lleno
- Revise que una cápsula nueva esté en el compartimento y en la posición correcta, que la perilla esté correctamente bloqueada y presione el botón para iniciar.
- Descalcifique de ser necesario.
- Abra el cabezal de la máquina y deje que la cápsula sea expulsada. Realice la limpieza según la sección de limpieza.

El café no está lo suficientemente caliente

- Pre caliente la taza con agua caliente
- Descalcifique de ser necesario.

Fuga o flujo de agua inusual.

- Revise que el tanque de agua esté correctamente colocado
- Descalcifique de ser necesario.

La máquina pasa a modo OFF.

- Para ahorrar energía, la máquina se apagará después de 2 minutos sin uso.
- La máquina puede apagarse en cualquier momento al presionar el botón durante 3 segundos.

Hay restos de café en la taza.

- Realice el proceso de limpieza dos veces
- Revise la sección **“Limpieza”**.

La máquina no inicia y tiene encendida la luz. Si hay parpadeo, revise los siguientes puntos.

- Revise que la perilla esté correctamente bloqueada.
- Si desea preparar un café o espresso, revise que una cápsula nueva está insertada en la posición correcta, que la perilla está correctamente cerrada y pulse el botón de inicio.
- Si está limpiando, descalcificando o vaciando el sistema, revise que no haya cápsulas insertadas, después cierre, bloquee la máquina y presione el botón para iniciar una de estas operaciones.

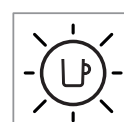
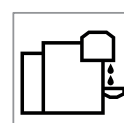
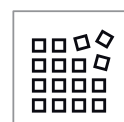
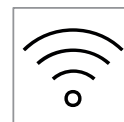
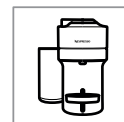

La máquina no inicia y la luz parpadea alternadamente; 1 parpadeo y 1 pausa.

La luz parpadea mientras la máquina está funcionando.

La máquina no inicia y la luz parpadea alternadamente; 1 parpadeo y 1 pausa.

- Llene el tanque de agua y presione el botón para iniciar
- Revise que la perilla esté correctamente bloqueada.
- Si el café fluye de manera normal, esto indica que la máquina funciona correctamente.
- Si solo fluye agua, la máquina está ejecutando la solicitud del usuario para la limpieza, descalcificación o vaciado del sistema. Por favor revise la sección correspondiente.
- Apague la máquina mediante la presión por 3 segundos del botón y después presiónelo de nuevo para encender la máquina. Ahora espere aproximadamente 20 minutos para permitir que la máquina se enfríe después del uso extensivo.
- Tomará un poco de tiempo antes de que el flujo de café inicie (debido a la lectura del código de barras y pre-infusión del café).
- Revise que una cápsula nueva esté en el compartimento y en la posición correcta, que la perilla esté correctamente bloqueada y presione el botón para iniciar.
- Llene el tanque de agua y presione el botón para iniciar
- Apague la máquina mediante la presión por 3 segundos del botón y después presiónelo de nuevo para encender la máquina. Ahora espere aproximadamente 20 minutos para permitir que la máquina se enfríe después del uso extensivo.

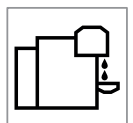

La luz parpadea alternadamente 2 veces y tiene una pausa continua. La máquina no inicia.

- Durante la preparación de café/espresso:
 - 1) Desbloquee la máquina y abra el cabezal de la máquina para revisar que una cápsula nueva y no dañada esté insertada en la posición correcta.
 - 2) Revise que la perilla está en la posición de bloqueo.
 - 3) Revise que el tanque de agua esté lleno
- Durante la descalcificación, vaciado y limpieza:
 - 1) Revise que no haya cápsula insertada.
 - 2) Revise que la perilla está en la posición de bloqueo.
- Durante la programación del volumen:
 - 1) Revise que la cápsula está correctamente colocada
 - 2) Por favor revise la sección correspondiente.
- Si el problema persiste:
 - 1) Desbloquee la máquina y abra el cabezal.
 - 2) Reemplace la cápsula (de ser necesario).
 - 3) Desconecte el cordón de alimentación del enchufe y conéctela nuevamente después de 10 segundos.
 - 4) Cierre el cabezal y presione el botón de encendido; presiónelo nuevamente para iniciar la preparación.

Si el problema persiste, contacte a **Nespresso**.

La luz parpadea alternadamente 3 veces y después se mantiene.

- La descalcificación es necesaria: la máquina puede ser utilizada algunas ocasiones más después de esta alerta hasta que la descalcificación se vuelve necesaria.

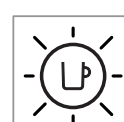
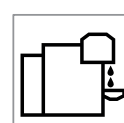
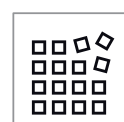
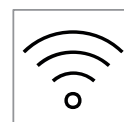
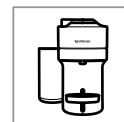

ESPECIFICACIONES

Voltaje	~220–240 V, 50–60 Hz, 1 300–1 500 W US, CA: 120 V, 60 Hz, 1 500 W MX: 127 V~, 60 Hz, 1 650 W
Frecuencia	2.402–2.480 GHz
RF Potencia de salida (EIRP)	Bluetooth 4 dBm Max. e.i.r.p. y Wi-Fi <20 dMm max. e.i.r.p.
Modo de espera	0.39 W/h
Modo ahorro de energía	Apagado automático: 2 min
Tiempo de calentamiento	30 segundos (cabezal cerrado y bloqueado)
Soporte de taza móvil para recetas grandes	Sí, dos posiciones
Longitud del cable del dispositivo	90 cm / 35.4 in
Dimensiones (W x D x H)	22 x 35.6 x 26.5 cm / 8.6 x 14 x 10.4 in
Peso	Vertuo Pop+: 3.6 kg / 7.9 lbs Vertuo Pop+ Deluxe: 3.7 kg / 8.1 lbs
Capacidad del tanque de agua	Vertuo Pop+: 750 ml / 25.4 fl oz Vertuo Pop+ Deluxe: 1.1 L / 37.2 fl oz
Capacidad del contenedor de cápsulas	8 espressos o 5 cápsulas mug

CÓDIGOS DE MÁQUINA

Nespresso	Breville	Delonghi
GCV6 GDV6	BNV520, BNV550, BNV530, BNV560, BNV540, BNV570	ENV92B, ENV92BAE, ENV92Y, ENV92YAE, ENV92AAE, ENV95S, ENV95SAE

