

Register Now

www.delonghi.photo

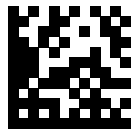

www.delonghi.com



E0141164

AIR FRY CONVECTION OVEN
FOUR À CONVECTION AIR FRY
HORNO DE CONVECCIÓN AIR FRY



De'Longhi

EN

page 10

FR

page 30

ES

pág. 57

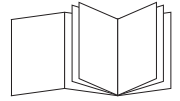

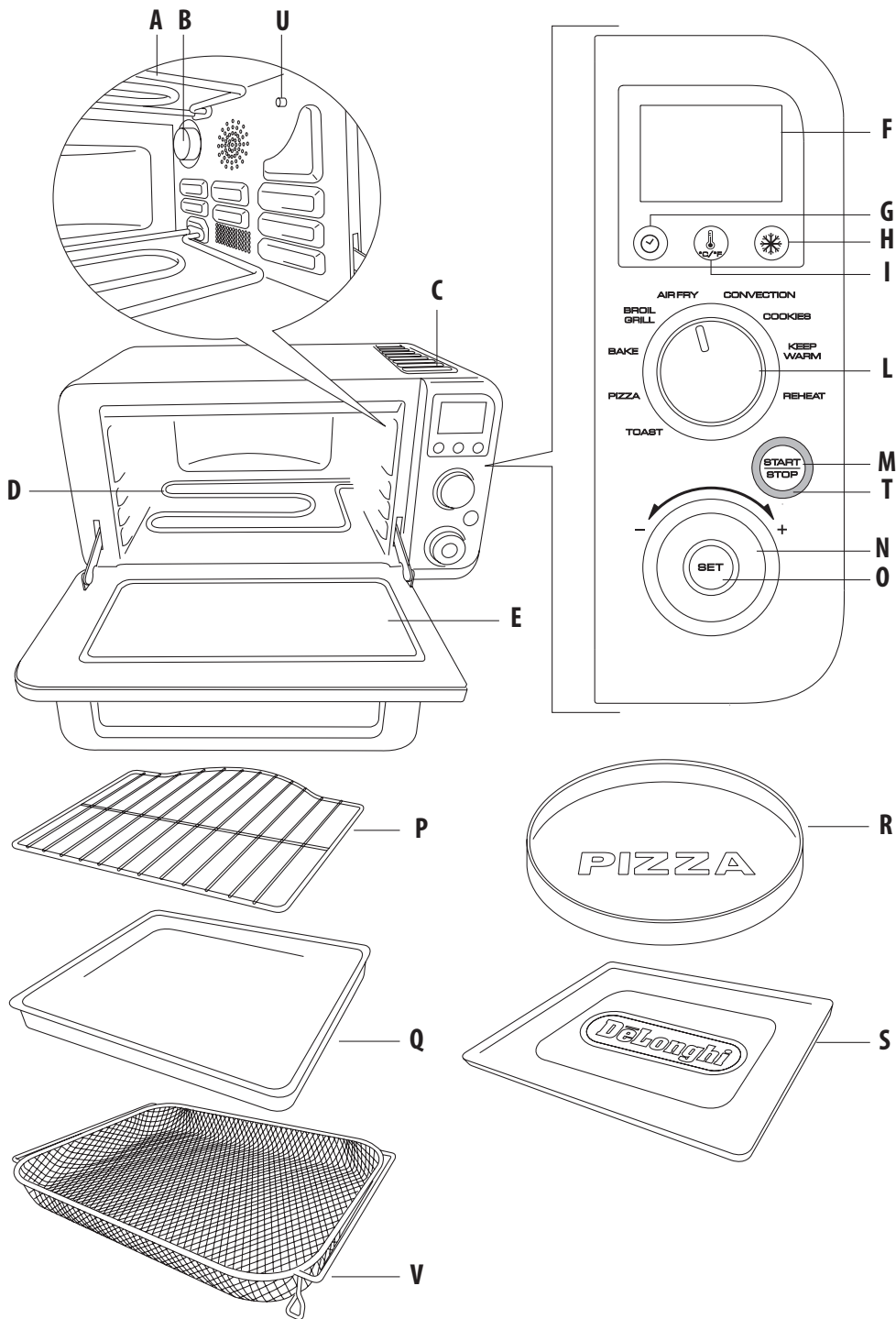

CONTENTS

ELECTRICAL CONNECTION	4
IMPORTANT SAFEGUARDS	5
TECHNICAL SPECIFICATION	6
DESCRIPTION OF THE APPLIANCE	6
INSTALLATION	6
ERROR MESSAGE	7
SETTING THE CLOCK	7
OVEN FUNCTION	7
FUNCTION SUMMARY TABLE	8
TOAST	10
BAKE	11
CONVECTION	12
BROIL/GRILL	13
PIZZA	14
AIR FRY	16
COOKIES	17
KEEP WARM	18
REHEAT	19
CARE AND CLEANING	20
DISPOSAL	20
RECIPES LIST	21
TROUBLESHOOTING	24
RECIPES	26

ELECTRICAL CONNECTION

Only use a three-pin, 120 Volt, 60 Hz power outlet

GROUNDING INSTRUCTIONS

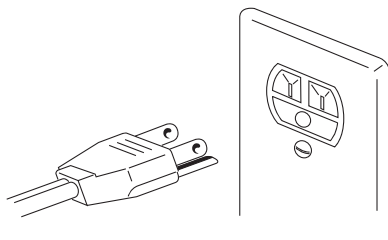

CAUTION: MAKE SURE THAT THE PLUG IS CORRECTLY GROUNDED

This appliance must be grounded: in the event of short circuits, the ground connection reduces the risk of electric shock, allowing the electrical current to be dispersed. This appliance is fitted with a power cable with ground wire.

The plug must be connected to a power outlet that has been correctly installed and grounded.

WARNING: IMPROPER USE OF THE GROUND WIRE MAY LEAD TO THE RISK OF ELECTRIC SHOCK.

If you are not sure that the power outlet is properly grounded, contact a qualified electrician.

The length of the power cable for this appliance has been devised so as to avoid the possibility of tripping on or getting entangled in a long cable.

If an extension cord is required, only use three-wire extension cords with three-pin plugs and sockets that fit the plug on the appliance.



The electrical ratings of the extension cord must be at least as great as the electrical ratings of the appliance. If a longer cable is required, an extension cord UL/CSA approved can be used.

When using an extension cord, make sure it does not hang loose in the work area or where someone may accidentally trip on it or get entangled in it.

Handle the power cable with care for longer life; avoid pulling or stressing the cable around the connectors to the power outlet and the appliance.

IMPORTANT SAFEGUARDS

When using electrical appliances, a number of fundamental safety rules must be observed, including the following:

- 1. READ ALL INSTRUCTIONS**
THIS PRODUCT IS DESIGNED FOR HOUSEHOLD USE ONLY. DO NOT USE OUTDOORS.
2. Do not use this appliance for purposes other than those it has been designed for.
3. Do not touch the hot surfaces. Only use the knobs or handles to operate the appliance .
4. Remove any objects located above the appliance. Do not use on surfaces that may be damaged by the heat. If the oven is used on countertop made in solid surface material (e.g. Silestone®, Corian®, etc.), follow carefully the indications of countertop manufacturer and/or supplier.
5. To avoid electric shock, do not immerse the appliance in water. See the instructions for cleaning.
6. If the appliance is used when children are around, pay careful attention to the metal walls of the oven and the door, which become very hot . The appliance must not be used by children or persons with reduced physical, sensory or mental capabilities or lack of experience and knowledge without supervision. Make sure that children do not play with the appliance.
7. Unplug the appliance from the power outlet before cleaning.
Wait for the appliance to cool down at least 30 minutes before fitting or removing any parts.
8. Never operate the appliance with the cable or the plug damaged, if any malfunctions have occurred, or if the appliance has been damaged in any way. Take the appliance to the nearest authorized service center, which will inspect it and, if necessary, will adjust or repair it.
9. After-sales accessories may be used if their shape, size and material are suitable for the use on this oven. The use of accessories that are not recommended by the manufacturer may cause injuries.
10. Do not let the power cable hang from the counter or come into contact with hot surfaces.

11. Do not place the appliance above or near a gas or electric cooker.
12. Use maximum care when moving the appliance or accessories if they contain hot oil or other hot liquids. Always use oven gloves.
13. If the plug heats up, contact a qualified electrician.
14. Use maximum care when removing the bake pan or throwing out the hot fat.
15. Do not use abrasive/aggressive/acid detergent, metal sponges or steel wool to clean the appliance.
16. To ensure the safe operation of the appliance, never introduce foods that are too large for the oven.
17. If the appliance, when operating, is covered by or comes into contact with flammable materials, such as curtains, fabrics or wall coverings etc. there will be risk of fire! Use extreme care to avoid these conditions.
18. **WARNING:** Never leave the appliance unattended when operating (especially when broiling or toasting).
19. When broiling, the bake pan and the wire racks must be used as described in the instructions.
20. Extreme care must be taken when using containers made from materials other than glass, metal or ovenproof ceramics.
21. Do not place any objects in the oven when it is not being used, apart from the accessories recommended by the manufacturer.
22. Do not place any of the following materials into or on top of the oven: paper, cardboard, plastic and the like.
23. Do not cover parts of the oven with metal foil, to avoid overheating. Do not place any materials over the vent openings (T), located on top housing.
24. To switch the appliance off, press START/STOP button.
25. To disconnect the appliance, turn off any control, than remove the plug from wall outlet.
26. Oversize food or metal utensils must not be inserted inside the oven as they may create risk of fire or risk of electric shock.
27. The appliance does not exceed 60 minutes "on" in a two hour period.
28. This product is in compliance with UL and CSA safety standards.

SAVE THESE INSTRUCTIONS

WARNING: After having removed the appliance from its packaging, check that the door is intact.

The door is made from glass and is therefore fragile. If it is visibly chipped, scored or scratched, it should be replaced. While using, cleaning or moving the appliance, avoid slamming or knocking the door. Do not pour cold liquid onto the glass while the appliance is hot.

WARNING: The accessories for cooking of this appliance are not suitable for food preservation. Avoid leaving for prolonged time acid substances as lemon/orange juice, tomato or vinegar on accessories surface. If left on surfaces for prolonged time these substances may damage and deteriorate the non stick coating.

WARNING: Caution should be exercised when using baking paper or metal foil to cover accessories, pans and dishes. Close contact with heating elements of baking paper and metal foil may cause overheating and risk of fire.



TECHNICAL SPECIFICATION

Voltage: 120 V ~ 60Hz

Absorbed power: 1800 W

Overall dimensions: LxPxH 193x173x118 in (490x445x300 cm)

DESCRIPTION OF THE APPLIANCE

- A Top heating element
- B Internal light
- C Vent openings
- D Lower heating element
- E Glass door
- F Display
- G  Clock button
- H  Frozen option button
- I  Internal temperature check button (°C/°F setting).
- L Function selection dial
- M START/STOP button
- N Time/temperature/toast color/pizza size/slices/ tray dial
- O SET button
- P Wire rack
- Q Bake pan
- R Pizza pan
- S Crumb tray
- T Red ON light
- U Temperature probe
- V Air fry basket

DISPLAY

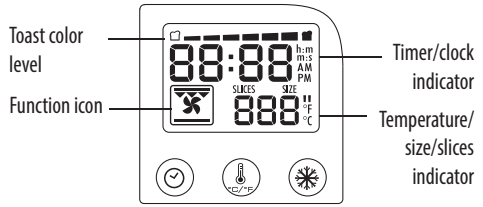

INSTALLATION

- Check that the appliance has not suffered any damage due to transportation.
- Place the appliance on a flat, stable surface out of the reach of children (the glass door becomes hot while the oven is in operation).
- Before using this appliance, move it away from the wall or any object on the counter top. Remove any object that may have been placed on top of the appliance. Do not use on surfaces where heat may be a problem.

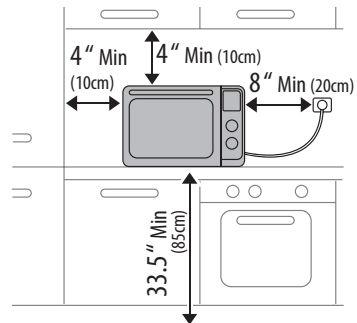

- In order to remove any protective substances on the heating elements surfaces, it is necessary to run the oven empty for 30 minutes in BAKE function at 450 °F, as first use. This operation may result in minimal smell and smoke. This is normal. Let the appliance cool down for 30 minutes after this operation.
- The crumb tray (S) must be always placed on oven bottom, under lower heating element (D).

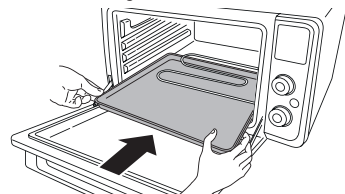

ERROR MESSAGES

If *ERR* message is shown on display, with relevant acoustic signal, the oven had a malfunction. Press START/STOP button (M) for 5 seconds to reset the control and disconnect the plug from wall outlet. Check troubleshooting section.

SETTING THE CLOCK

The first time the appliance is connected to the main electricity supply or after it has been without power for some time, it will beep and "01:00 AM" blink on the display. After 5 seconds the display will turn off, since the clock has not been set, and the electronic control will go into stand-by mode. To set the time, proceed as follows:

Press the Clock button (G) for at least 2 seconds.

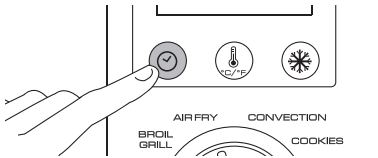

The hour flashes.



Set the hour with Time/temperature/toast color/pizza size/slices/tray dial (N).

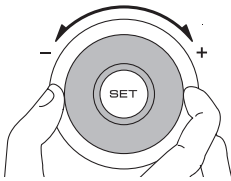

Press the SET button (O). The minutes flash.

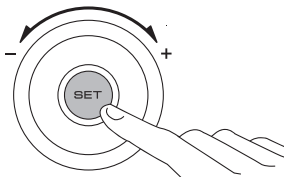

Set the minutes with Time/temperature/toast color/pizza size/slices/tray dial (N).



Press the SET button (O). The set time is displayed.



If you want to adjust the time later, repeat the setting procedure described above. The electronic control must be in stand-by mode to adjust the clock.

OVEN FUNCTION









In the stand-by mode, the Display shows the clock (if set) or 01:00.

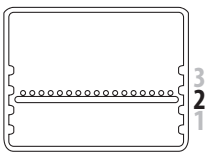

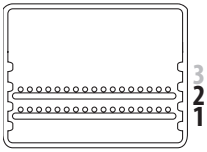

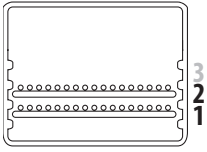

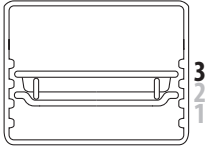
- Press any button/key (G H I M O) or turn any dial (L N). The oven turns on. The modifiable values flash. If there are no buttons pressed or dials turned within 2 minutes of the selection mode function, the control defaults back into stand-by mode.
- Turn the Function selection dial (L) to select the desired function.
- Turn the Time/temperature/toast color/pizza size/slices/tray dial (N) to set the time if needed (not required in some programs).
- Press the SET button (O) to set the temperature.
- In some functions the temperature is automatically set (the display doesn't show the preset temperature).
- Press the START/STOP button (M) to start cooking. The red ON light (T), that is located around the edge of the START/STOP button (M), turns on. When the timer elapsed, the display shows "END" and plays a sound signal.

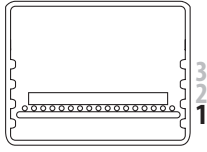
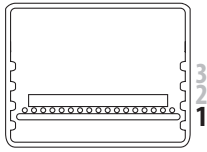
Press START/STOP button (M) to reset the oven. The oven goes into stand-by mode. In the BAKE, CONVECTION, AIR FRY, REHEAT and COOKIES functions, the oven plays a sound signal when the first target temperature is reached. In BAKE, AIR FRY, REHEAT and CONVECTION function it is possible to check the internal temperature by pressing the Internal temperature check button (I). The temperature is displayed for 5 seconds.

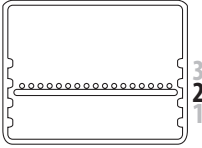
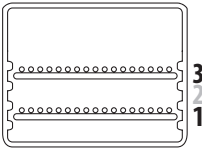
- It is possible to choose the temperature visualization in °F or in °C. Default setting is in °F. To change this setting, select BAKE, AIR FRY, REHEAT or CONVECTION function, press Internal temperature check button (I) 1 time. The visualization will change to °C with acoustic signal. To come back to °F visualization repeat the same operation.

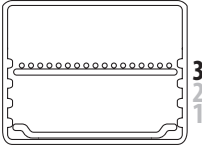
FUNCTIONS SUMMARY TABLE

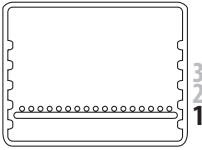
FUNCTION		TEMPERATURE	TIMER	WIRE RACK AND BAKE PAN POSITION	RECIPES
 TOAST		(Auto selected)	(Auto selected)	 wire rack in position 2	Specific for toasting slices of bread.
 BAKE		170°F - 450°F 75°C - 230°C	1:00 (minutes) - 2:00 (hours)	 wire rack in position 1 or 2	Ideal for: cakes fish lasagna
 CONVECTION		170°F - 450°F 75°C - 230°C	1:00 (minutes) - 2:00 (hours)	 wire rack in position 1 or 2	Ideal for: quiches bread pastry cakes
 AIR FRY		375°F - 450°F 190°C - 230°C	1:00 (minutes) - 2:00 (hours)	 air fry basket in position 3	Ideal for: frozen food (as potatoes, nugget etc.) fresh chicken, sausage, etc.
 PIZZA	Frozen 	(Auto selected)	(Auto selected and adjustable)	 pizza pan on wire rack in position 1	Automatic program for crispy frozen pizza.
	Fresh	(Auto selected)	(Auto selected and adjustable)	 pizza pan on wire rack in position 1	Automatic program for perfect fresh pizza.

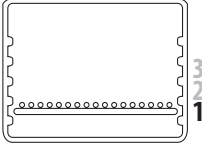
FUNCTION		TEMPERATURE	TIMER	WIRE RACK AND BAKE PAN POSITION	RECIPES
 COOKIES	1tr	(Auto selected)	(Auto selected and adjustable)	 wire rack in position 2	Automatic program for perfect cookies.
	2tr (*)	(Auto selected)	(Auto selected and adjustable)	 wire racks in position 1 and 3	Automatic program for cookies for the entire family.
 BROIL/GRILL		(Auto selected)	1:00 (minutes) - 2:00 (hours)	 wire rack in position 3, bake pan on the lower heating element	Ideal for: pork chops sausages pork ribs
 KEEP WARM		(Auto selected)	1:00 (minutes) - 6:00 (hours)	 wire rack in position 1	Ideal to keep prepared food warm. This function can be also used as slow cooker.
 REHEAT		(Auto selected)	1:00 (minutes) - 2:00 (hours)	 wire rack in position 1	Ideal for reheating leftovers.

(*) the second wire rack is sold as accessory.

TOAST

Place the slices to toast (2, 4 or 6) on the wire rack (P) and insert in the oven in position 2.

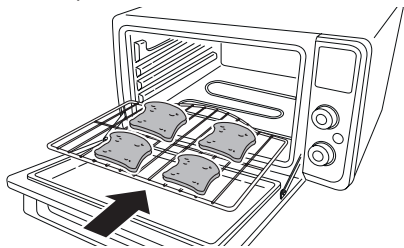

For a better toasting result place the slices as shown.



2 slices

4 slices

6 slices

The edges of the slices should be aligned and close to the central wire. Close the door.

Turn the Function selection dial (L) in TOAST position.

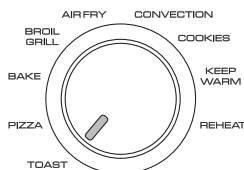

The oven turns on.



Turn the Time/temperature/toast color/pizza size/slices dial (N) to select the desired number of slices to toast.

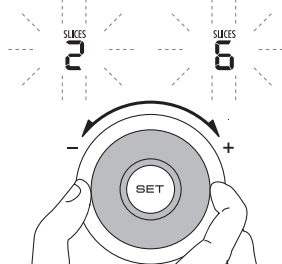

Press the SET button (O).

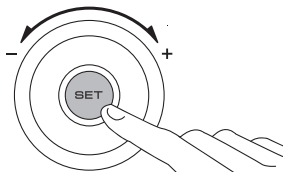

Set the desired level of toasting by turning the Time/temperature/toast color/pizza size/slices/tray dial (N).

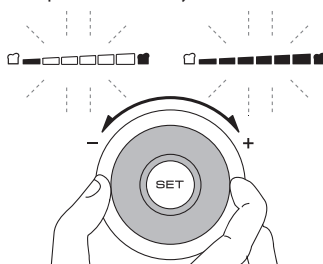

Press the START/STOP button (M) to start cooking.

The red ON light (T), that is located around the edge of the START/STOP button (M), turns on.



The oven starts the cooking process.

At the end of the set time the appliance will play a sound signal and the display will show *END*.

Beep!
Beep!
Beep!

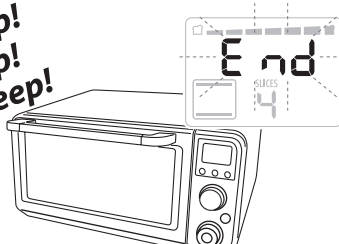

Open the door and remove the food. Take great care when taking the food out of the oven. Use oven gloves.

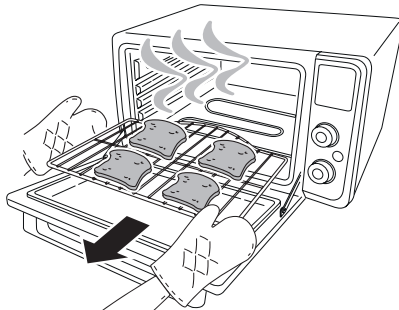

BAKE

Turn the Function selection dial (L) in BAKE position.

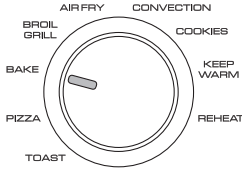

Turn the Time/temperature/toast color/pizza size/slices/tray dial (N) to set the desired time. The default time is 1:00 (hour), the default temperature setting is 360°F.

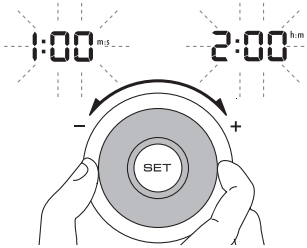

Press the SET button (O).

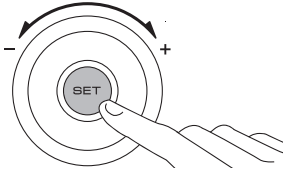

Set the desired temperature by turning the Time/temperature/toast color/pizza size/slices/tray dial (N).

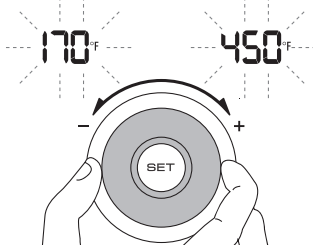

Press the START/STOP button (M) to start cooking.

The red ON light (T), that is located around the edge of the START/STOP button (M), turns on.



The oven starts the preheating phase. *PRE HEAT* message is shown on display. When the oven reaches the set temperature, an audible signal will sound. The countdown will start. Place the food on the bake pan (Q) and insert in the oven over the rack in position 1 or 2.

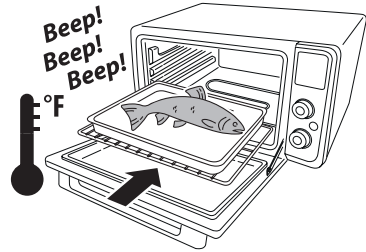

Close the door.

At the end of the set time the appliance will play a sound signal and the display will show *END*.

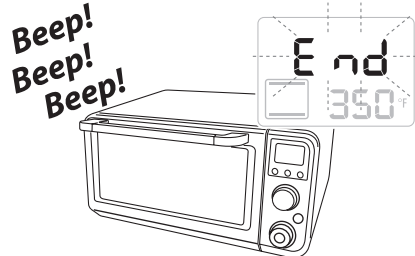

Open the door and remove the food. Take great care when taking the food out of the oven. Use oven gloves.

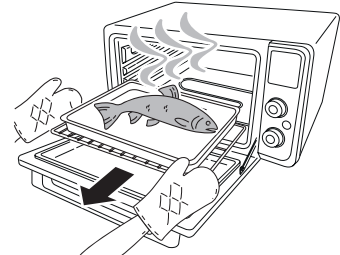



CONVECTION

Turn the Function selection dial (L) in CONVECTION position.

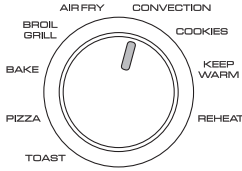

Turn the Time/temperature/toast color/pizza size/slices/tray dial (N) to set the desired time. The default time is 1:00 (hour), the default temperature setting is 360°F.

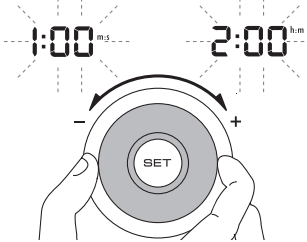

Press the SET button (0).

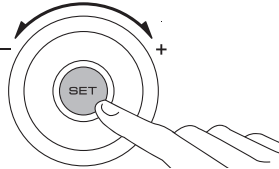

Set the desired temperature by turning the Time/temperature/toast color/pizza size/slices/tray dial (N).

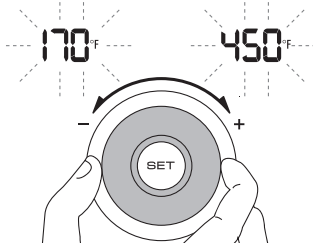

Press the START/STOP button (M) to start cooking.

The red ON light (T), that is located around the edge of the START/STOP button (M), turns on.



The oven starts the preheating phase. *PRE HEAT* message is shown on display. When the oven reaches the set temperature, an audible signal will sound. The countdown will start. Place the food on the bake pan (Q) and insert in the oven over the rack in position 1 or 2.

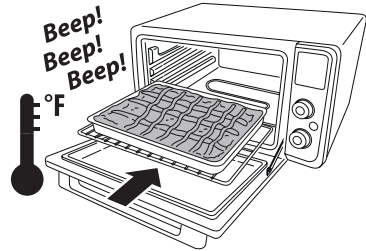

Close the door.

At the end of the set time the appliance will play a sound signal and the display will show *END*.

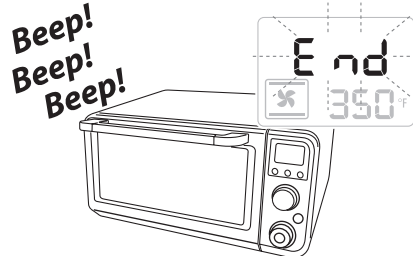

Open the door and remove the food. Take great care when taking the food out of the oven. Use oven gloves.

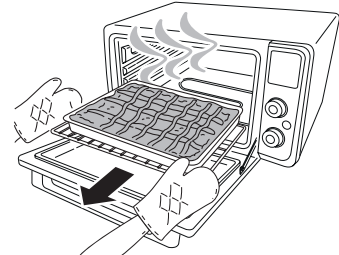



BROIL/GRILL

Place the food on the wire rack (P) and insert in the oven.

No preheat is needed.

The wire rack (P) and the bake pan (Q) must be positioned as shown in the figure (position 3 and over the lower heating element).

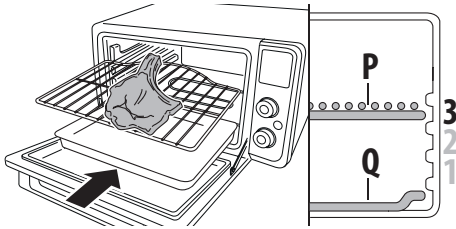

Close the door.

Turn the Function selection dial (L) in BROIL/GRILL position.

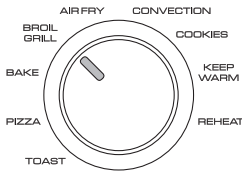

Turn the Time/temperature/toast color/pizza size/slices/tray dial (N) to set the desired time. Default time is 30 minutes.

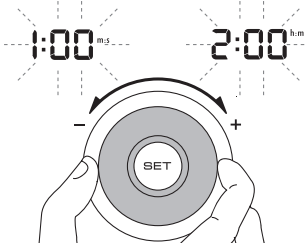

Press the START/STOP button (M) to start cooking.

The red ON light (T), that is located around the edge of the START/STOP button (M), turns on.



The oven starts the cooking process.
Turn the food halfway through cooking.

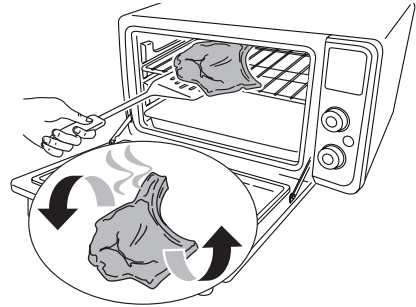

At the end of the set time the appliance will play a sound signal and the display will show END.

**Beep!
Beep!
Beep!**

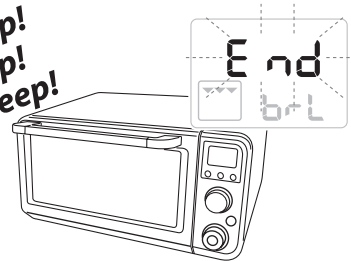

Open the door and remove the food. Take great care when taking the food out of the oven. Use oven gloves.

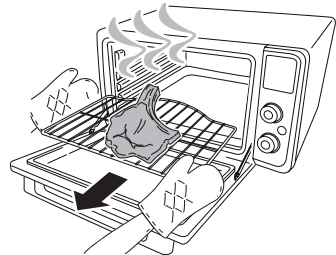

The bake pan located over the lower heating element works as fat container, collecting the fat or grease from grilled food. Carefully remove the bake pan and handle with care as you remove the fat drippings.

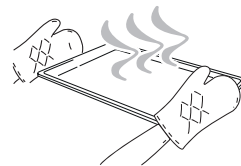



PIZZA

Pizza is special automatic function that incorporates preset programs. Temperature, cooking time and cooking mode are automatically selected. Cooking time is extendable to desired cooking results, at the end of cooking process.

Place the pizza on the pizza pan (R) and insert in the oven in position 1.

No preheat is needed.

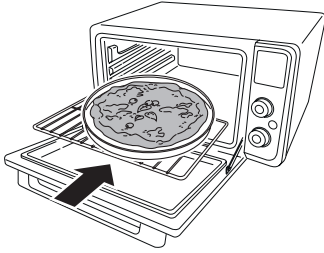

Close the door.

Turn the Function selection dial (L) in PIZZA position. Default mode is "FROZEN".

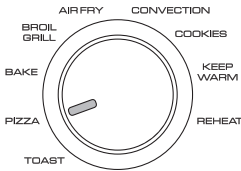

Pressing the Frozen option button (H) allows you to disable the 'frozen' option, to cook 'fresh' pizza.

Further pressing will return 'frozen' mode.

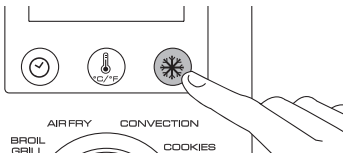

Turn the Time/temperature/toast color/pizza size/slices/tray dial (N) to set the desired pizza size.

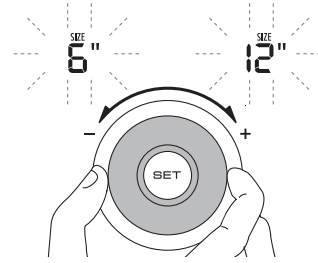

Press the SET button (O).

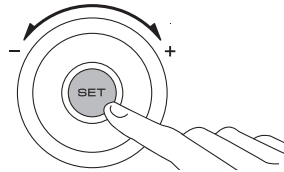

Set the desired level of crusting by turning the Time/temperature/toast color/pizza size/slices/tray dial (N).

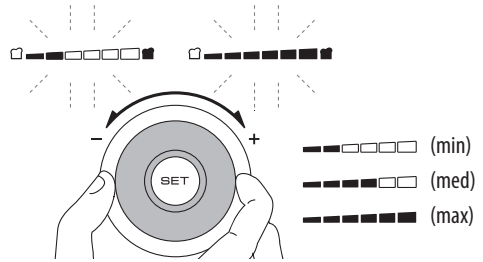

For thin pizza we suggest min crust level. For thick pizza we suggest max level of crust.

Press the START/STOP button (M) to start cooking.

The red ON light (T), that is located around the edge of the START/STOP button (M), turns on.



The oven starts the cooking process.

During cooking 'fresh' pizza only, the oven will play a sound signal (6 minutes before the end of cooking time). It is a signal to add mozzarella or soft cheese topping to your pizza.

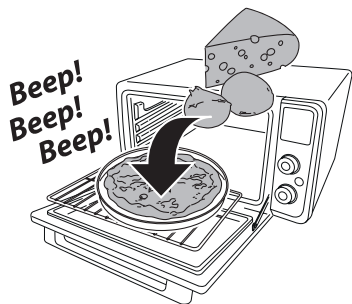

Close the door and complete the cooking process. At the end of the set time the appliance will play a sound signal and the display will show 00:00 flashing. The control is now in 'waiting mode'. In this state you can add up to 10 minutes, if necessary, to complete the cooking. This state is kept for 5 minutes, after that the control will turn off the oven automatically. Turn the Time/temperature/toast color/pizza size/slices/tray dial (N) to adjust up to 10 additional minutes, if necessary, and press the START/STOP button (M); at the end of time, the control will turn off the oven.

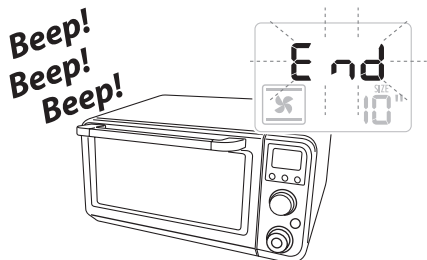

Open the door and remove the food. Take great care when taking the food out of the oven. Use oven gloves.

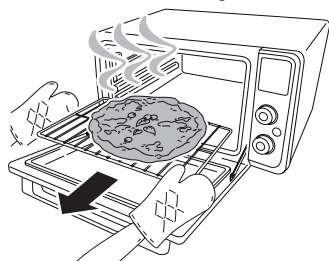

Cooking 2 'frozen' pizza

To cook 2 'frozen' pizzas at the same time as shown in figure (position 1 and 3).

(*) Requires optional rack. The accessory can be purchased at After-Sales Service Centers or household appliance dealers.

For cooking 2 pizza set the size of single one, than set the crust

level at maximum.

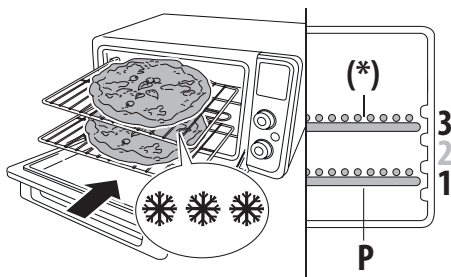

At half cooking time, rotate the two pizzas, placing the top one on the bottom rack and vice-versa.

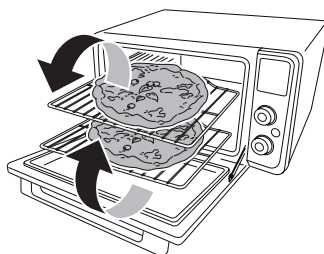



AIR FRY

Turn the Function selection dial (L) in AIR FRY position.

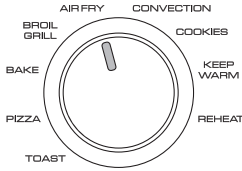

Turn the Time/temperature/toast color/pizza size/slices/tray dial (N) to set the desired time. The default time is 30 (min), the default temperature setting is 450°F.

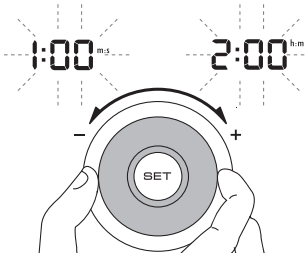

Press the SET button (O).

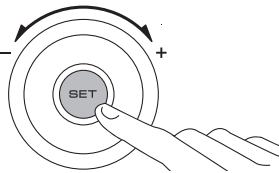

Set the desired temperature by turning the Time/temperature/toast color/pizza size/slices/tray dial (N).

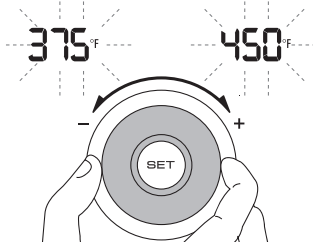

Place the food on the air fry basket and insert in the oven in position 3. Close the door.

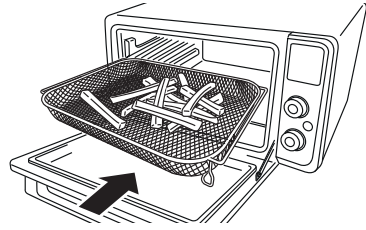

NOTE: When cooking fatty foods (e.g. chicken wings) use the bake pan to prevent the oil dripping. Fit the air fry basket (V) with the bake pan (Q) as shown in the figure and turn the food halfway through cooking.

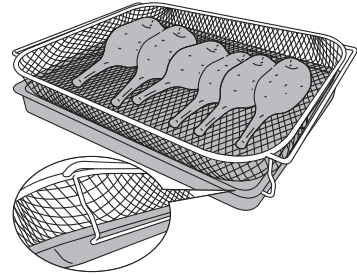

Press the START/STOP button (M) to start cooking.

The red ON light (T), that is located around the edge of the START/STOP button (M), turns on.



At the end of the set time the appliance will play a sound signal and the display will show *END*.

**Beep!
Beep!
Beep!**

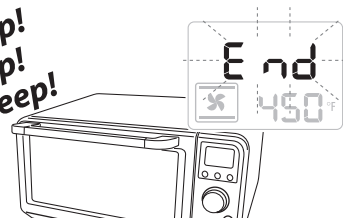

Open the door and remove the food. Take great care when taking the food out of the oven. Use oven gloves.

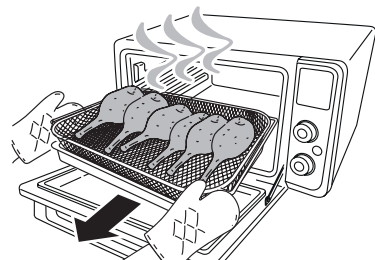



COOKIES

Cookies is special automatic function that incorporates preset programs. Temperature and cooking mode are automatically selected. Cooking time is adjustable for the desired cooking results. Turn the Function selection dial (L) in COOKIES position.

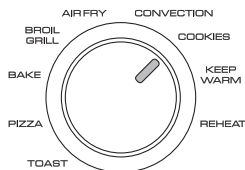

Turning the Time/temperature/toast color/pizza size/slices/tray dial (N) is possible to select "1tr" mode (1 tray of cookies) or "2tr" mode (2 trays of cookies).

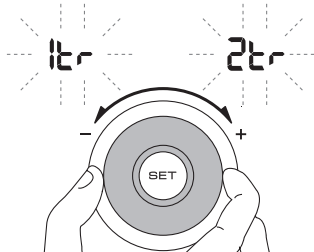

Press the SET button (O).

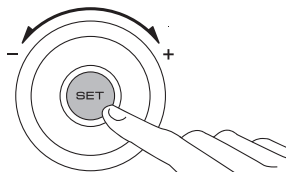

To modify the preset time, turn the Time/temperature/toast color/pizza size/slices/tray dial (N) to set the desired timer.

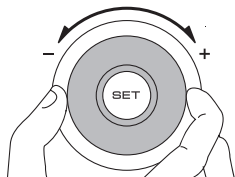

Press the START/STOP button (M) to start cooking.

The red ON light (T), that is located around the edge of the START/STOP button (M), turns on.



The oven starts the preheating phase and the display will show **PRE HEAT**. When the oven reaches the set temperature, an audible signal will sound.

Place the food on the bake pan and insert over the wire rack in the oven (pos. 2).

NOTE: You must press Start/Stop button (M) to start the cooking.

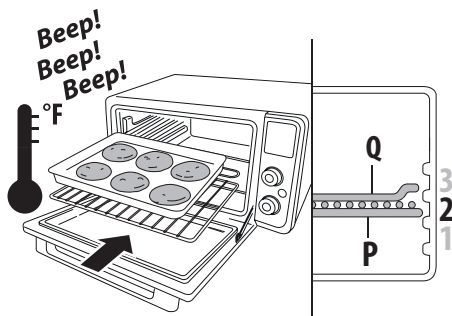

Cooking 2 trays of cookies

To cook two trays of cookies at the same time, place the wire racks covered by aluminium foil as shown (position 1 and 3).

(*) Requires optional rack. The accessory can be purchased at After-Sales Service Centers or household appliance dealers.

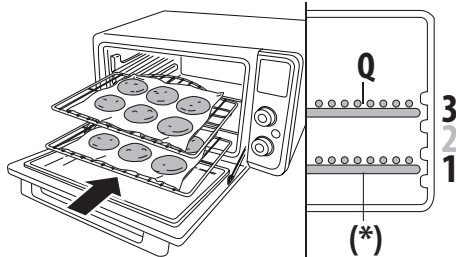

During two trays cookie mode the oven will play 3 beeps. It is a signal to swap the trays, placing the top one on the bottom and vice-versa and press the START/STOP button (M).

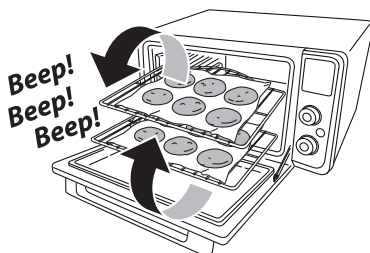

The oven will restart the cooking function.

If START/STOP button (M) is not pressed within 15 minutes, the oven will automatically restart the function.

At the end of the set time the appliance will play a sound signal and the display will show 00:00.

**Beep!
Beep!
Beep!**

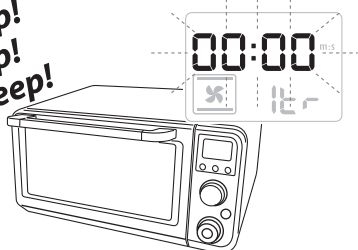

The control is now in 'waiting mode'. In this state you can add up to 10 minutes, if necessary, to complete the cooking.

This state is kept for 5 minutes, after that the control will turn off the oven automatically.

Turn the Time/temperature/toast color/pizza size/slices/tray (N) to adjust up to 10 additional minutes, if necessary, and press the START/STOP button (M) at the end of time, the control will turn off the oven.

Open the door and remove the food. Take great care when taking the food out of the oven. Use oven gloves.

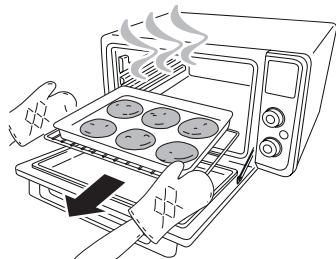

 **KEEP WARM**

Place the food previously cooked on the bake pan over the rack. The wire rack must be positioned as shown in the figure (position 1).

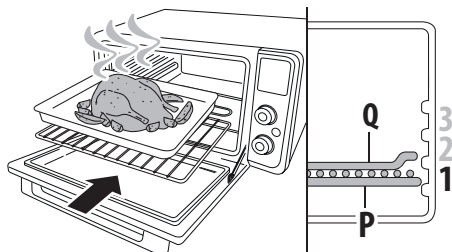

Close the door. Turn the Function selection dial (L) in KEEP

WARM position.



Turn the Time/temperature/toast color/pizza size/slices/tray dial (N) to set the desired time. The default time is 1:00 (hour).

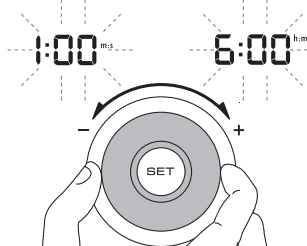

Press the START/STOP button (M) to start cooking. The red ON light (T), that is located around the edge of the START/STOP button (M), turns on.



At the end of the set time the appliance will play a sound signal and the display will show END.

**Beep!
Beep!
Beep!**

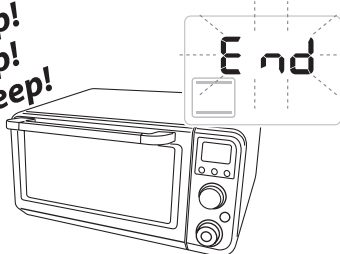

Open the door and remove the food. Take great care when taking the food out of the oven. Use oven gloves.

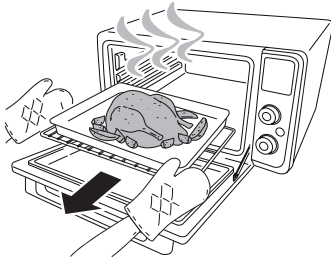

Slow cooker

The keep warm function, thanks to its low and accurate temperature, it can also be used as a slow cooker. In this function the time can be set up to 6 hours.



REHEAT

This function is ideal for reheating leftovers.

Place the food on the bake pan (Q) and insert in the oven over the wire rack inserted in position 1.

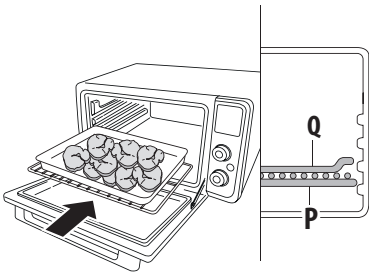

Close the door.

Turn the Function selection dial (L) in REHEAT position.

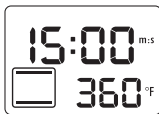
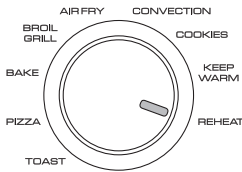

Turn the Time/temperature/toast color/pizza size/slices/tray dial (N) to set the desired time.

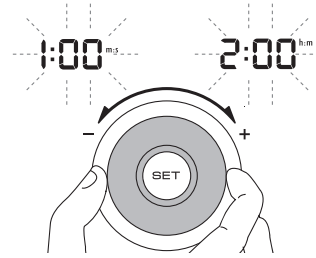

Press the START/STOP button (M) to start cooking.

The red ON light (T), that is located around the edge of the START/STOP button (M), turns on.



Close the door.

The oven starts the cooking process.

At the end of the set time the appliance will play a sound signal and the display will show *END*.

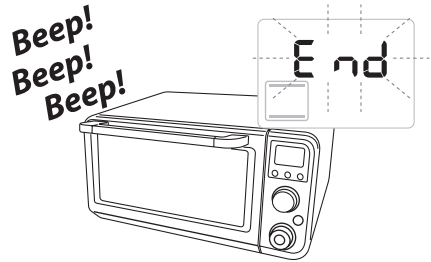

To turn the appliance off during running function or reset the control at end of time when *END* is showed on display, press the START/STOP button (H) for 2 seconds.

Open the door and remove the food.

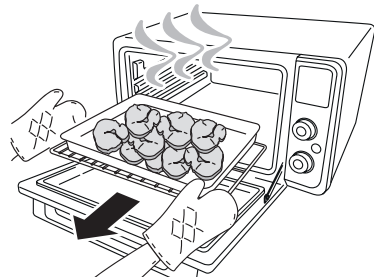

CARE AND CLEANING

Frequent cleaning prevents the formation of smoke and bad odors during cooking. Do not let fat and food residues accumulate inside the appliance.

Before any maintenance or cleaning operation, unplug the oven and wait for it to cool down.

Clean the door, the inside walls and surfaces of the oven with a soap and water solution; dry thoroughly. Never use steel wool or abrasive sponges for cleaning.

To clean the aluminum surfaces on the inside of the oven, never use products that corrode aluminum (detergents in spray cans) and never scrape the walls with sharp objects.

Never use corrosive or aggressive detergents.

To clean the outside surface always use a damp sponge.

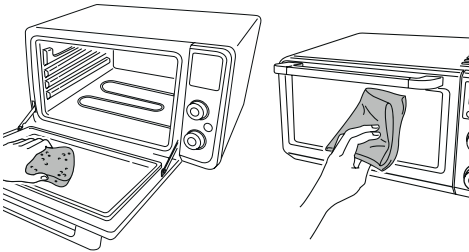

Avoid using abrasive products that may damage the exterior.

Make sure water or liquid soap does not seep into the vents on the top of the oven. Never clean the oven door while its hot.

Pay attention when cleaning the temperature probe area ! Avoid to hit the probe during cleaning operations.

Never immerse the appliance in water; never wash it under a jet of water.

Never use flammable liquids for cleaning.

All accessories are washed like normal dishes, either by hand or in the dishwasher, except crumb tray and Air fry basket.

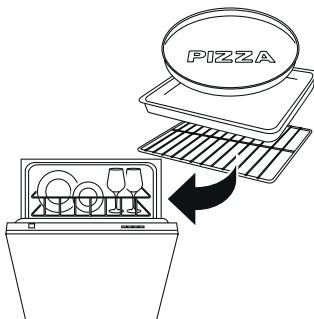

Slide the crumb tray (S) out from the bottom of your oven. Wash by hand. Should the dirt be difficult to remove, rinse the crumb tray with hot soapy water and if necessary, scour it delicately, without scratching it. Carefully dry after operation.

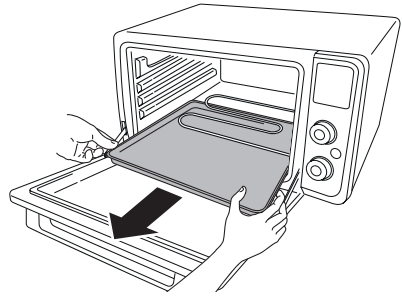

When the oven is on, the internal light (B) inside the oven is always on.

To replace the bulb, proceed as follows: ensure that the appliance has cooled down, **unplug the appliance from the power outlet**, unscrew the glass cover and replace the bulb with a new one of the same type (resistant to high temperatures) and then replace the glass cover.

Bulb type: E14, 15W, 300 °C, 110-130V

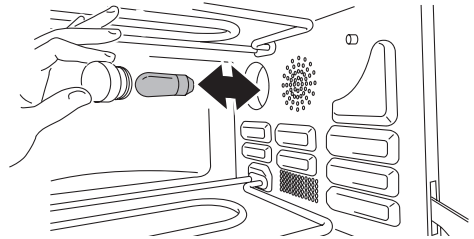

Never place heavy weights over the door when it is open, in order to avoid damages on its structure and the glass.

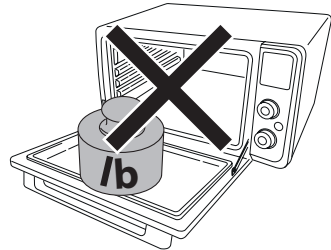









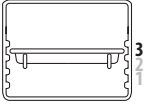

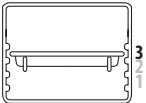

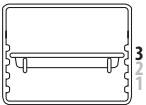

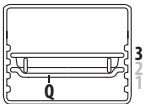

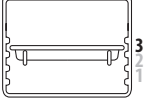

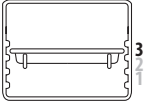

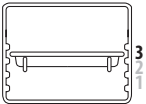

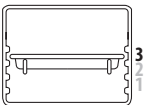

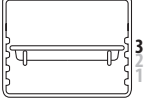

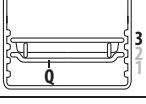

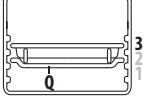



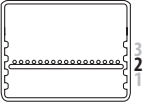

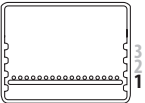

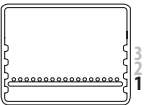
DISPOSAL

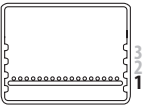

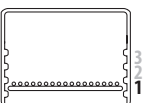
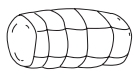
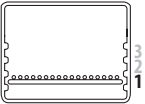

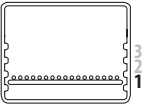

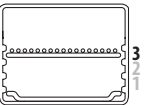

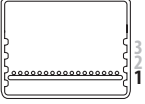

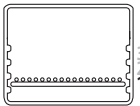

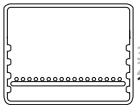
When disposing of appliance, follow local regulations of your state.

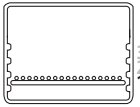
Consumers should contact their local authority or retailer for information concerning the correct disposal of their old appliance.

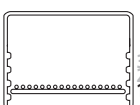
RECIPES LIST

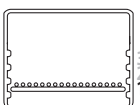
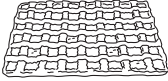
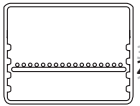
FOOD ITEM	QUANTITY	WIRE RACK AND BAKE PAN POSITION	FUNCTION	TEMPERATURE	TIME
 *** Frozen potatoes	1.1 lb 500g		AIR FRY	450 °F 230°C	25-30min
 *** Beer Batter Shrimp	1 pound 450g		AIR FRY	425°F	12-15 min
 *** Chicken Nuggets	1 pound 450g		AIR FRY	400°F	15 min
 *** Chicken Wings	18 oz 510g		AIR FRY	450°F	15 min
 *** French Fries	1 pound 450g		AIR FRY	450°F	25-30 min
 *** Mozzarella Sticks	1 pound 450g		AIR FRY	450°F	8-9 min
 *** Fish Sticks	1 pound 450g		AIR FRY	450°F	12-14 min
 *** Jalapeno Poppers	1 pound 450g		AIR FRY	450°F	12-14 min
 *** Sweet Potato Fries	1 pound 450g		AIR FRY	425°F	15 - 20 min
 Hand-cut Fries	2 russets (about 1 lb) cut 4" L x 1/4" thick		AIR FRY	425°F	20-25 min
 Bacon	7 pieces (single layer in the basket)		AIR FRY	425°F	15 - 20 min

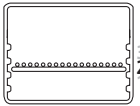
FOOD ITEM	QUANTITY	WIRE RACK AND BAKE PAN POSITION	FUNCTION	TEMPERATURE	TIME
 <p>Quiche</p>	1.5 lb 700g		CONVECTION	390 °F 200 °C	30-35 min
 <p>Bread</p>	1.0 lb 500g		CONVECTION	360 °F 180 °C	35-40 min
 <p>Cannelloni</p>	2.2 lb 1000g		BAKE	360 °F 180 °C	35-40 min
 <p>Chicken</p>	3.8 lb 1200g		CONVECTION	420 °F 215 °C	55-60 min
 <p>Chicken piece</p>	2.2 lb 1000g		CONVECTION	420 °F 215 °C	35-40 min
 <p>Roast</p>	2.2 lb 1000g		CONVECTION	420 °F 215 °C	65-70 min
 <p>Meat and vegetable kebabs</p>	2.2 lb 1000g		CONVECTION	390 °F 200 °C	40-45 min
 <p>Meat</p>	1.2 lb 550g		BROIL/GRILL	Auto selected	25-30 min
 <p>Fish</p>	2.2 lb 1000g		BAKE	400 °F 200 °C	25-30 min

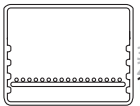
FOOD ITEM	QUANTITY	WIRE RACK AND BAKE PAN POSITION	FUNCTION	TEMPERATURE	TIME
 Fresh potatoes	2.2 lb 1000g		CONVECTION	400 °F 200 °C	45-50 min
 Tomato gratin	2.2 lb 1000g		BAKE	400 °F 200 °C	25-30 min
 *** Frozen brioche	4		CONVECTION	360 °F 180 °C	20-25 min
 Sponge cake	1.5 lb 700g		BAKE	320 °F 160 °C	20-25 min
 Cake	1.6 lb 750g		BAKE	360 °F 180 °C	30-35 min
 Pie	2.2 lb 1000g		BAKE	360 °F 180 °C	30-35 min
 Muffins	12		BAKE	340 °F 170 °C	20-25 min
 Plum cake	2.0 lb 900g		BAKE	300 °F 150 °C	85-90 min

TROUBLESHOOTING

ERROR MESSAGE ON DISPLAY	DESCRIPTION	POSSIBLE PROBLEMS	SOLUTION
E0:11 Err	Temperature probe malfunction	The electronic control detected a malfunction on temperature probe	Record the error number. Disconnect the plug from wall outlet. The temperature probe need to be replaced. Contact a De'Longhi customer service reporting the error number.
E0:12 Err	Temperature probe malfunction	The electronic control detected a malfunction on temperature probe	Record the error number. Disconnect the plug from wall outlet. The temperature probe need to be replaced. Contact a De'Longhi customer service reporting the error number.
E0:21 Err	Target temperature not reached : The oven cannot reach the target temperature in a reasonable time range	The electronic control detected an excessive time to reach the target temperature inside the oven	Record the error number. Disconnect the plug from wall outlet. First check that the oven door has been closed during the use. If door is kept open while in use , the oven cannot reach the target temperature. If oven door was properly closed , the heating elements could be damaged. Contact a De'Longhi customer service reporting the error number.
E0:22 Err	Over temperature: The oven reaches excessive temperature	The electronic control detected an excessive temperature inside the oven	Record the error number. Disconnect the plug from wall outlet. The electronic control could be damaged. Contact a De'Longhi customer service reporting the error number.
E0:27 Err	Unexpected heating : The temperature probe detected a temperature rise when heating elements should be OFF	The electronic control detected an unexpected temperature rise inside the oven, when heating elements should be not energized	Record the error number. Disconnect the plug from wall outlet. The electronic control could be damaged. Contact a De'Longhi customer service reporting the error number.

ERROR MESSAGE ON DISPLAY	DESCRIPTION	POSSIBLE PROBLEMS	SOLUTION
E0:28 Err	Electronic control cooling system problem	The electronic control detected a malfunction on its automatic cooling system	Record the error number. Disconnect the plug from wall outlet. Check that vent openings located on bottom side or top side of the oven are not obstructed by foreign objects such as fabrics , papers or similar. Remove any material from supporting surface where the oven is located or from top side of the oven cover. If above case was not , and same error occur again , the electronic control could be damaged. Contact a De'Longhi customer service reporting the error number.
E0:29 Err	Electronic control cooling system problem	The electronic control detected a malfunction on its automatic cooling system	Record the error number. Disconnect the plug from wall outlet. Check that vent openings located on bottom side or top side of the oven are not obstructed by foreign objects such as fabrics , papers or similar. Remove any material from supporting surface where the oven is located or from top side of the oven cover. If above case was not , and same error occur again , the electronic control could be damaged. Contact a De'Longhi customer service reporting the error number.

POSSIBLE PROBLEMS	SOLUTION
Oven will not switch ON	<ul style="list-style-type: none"> • Check that the power plug is properly inserted into wall outlet • Insert the power plug into a different outlet • Verify the circuit breaker <p>If above solution do not solve the problem , probably the oven had a malfunction. Contact a De'Longhi customer service.</p>
LCD display light has gone out	The oven goes in standby mode , when not used for 120 seconds , if Clock was not set. When Clock is set , the display light is kept ON
Clock setting has gone out	If the LCD display light has gone out even if Clock was previously set , a power supply interruption greater than 5 seconds occurred. The electronic control has been reset. Set the Clock again.
Oven lamp is OFF while oven is ON	<ul style="list-style-type: none"> • The bulb is broken. Replace the bulb. • The bulb is not properly screwed into its housing. Verify that it is completely screwed. <p>If above solution do not solve the problem , probably the electronic control of the lamp had a malfunction. Contact a De'Longhi customer service.</p>
The pizza does not cook evenly	Some large pizza , or particular dough pizza may brown unevenly .We suggest in these cases to turn half way through the cooking time the pizza for a perfect final result.
Steam coming out from housing	This is normal. The oven is vented to release excessive steam created from bread or high-moisture content foods.
Water dripping on internal glass	This is normal. The condensation created by toasting bread and frozen bread will run down the inside of door glass , and collected into a special slot on internal lower side of door.

RECIPES

ROSEMARY CHICKEN & POTATOES

Serves 4

Preparation Time: 10 minutes

Cook: 40 minutes

Total time: 50 minutes

Ingredients

- 3 Tbsp olive oil
- 2 Tbsp chopped fresh rosemary
- 1 garlic clove, minced
- 3/4 tsp salt
- 1/4 tsp pepper
- 2 large all-purpose potatoes (1 1/4 lbs.) cut into 1/4-inch-thick rounds
- 5 large chicken drumsticks, about 1 3/4 lbs.

Directions

- 1 Combine the olive oil, rosemary, garlic, salt, and pepper in a large bowl. Add the chicken and potatoes and toss until well coated.
- 2 Slide the wire basket into the baking tray. Arrange the potato slices in a single layer on the basket. Place the drumsticks on top of the potatoes.
- 3 Turn the function dial to Air Fry. Set the temperature to 425°F and the timer for 40 minutes.
- 4 Place the basket in position 3 and cook until the potatoes are tender and an instant-read thermometer inserted into the thickest part of a drumstick reads 165°F, 35 – 40 minutes.

CAULIFLOWER FRITTERS

Serves 4

Preparation Time: 15 minutes

Cook: 40 minutes

Total time: 55 minutes

Ingredients

- 1 cup panko bread crumbs
- 3 Tbsp olive oil
- 3/4 tsp salt
- 3/4 tsp garlic powder
- 1 1/4 cups rice flour
- 3/4 cup chilled seltzer
- 3/4 tsp salt
- 4 cups cauliflower florets

Directions

- 1 Combine the panko, olive oil, salt, and garlic powder in a large bowl until well mixed. Whisk together the flour and seltzer in another large bowl until smooth. Add the cauliflower and toss until well coated. Toss the cauliflower, a few pieces at a time, in the panko mixture until coated. Transfer the florets to a baking sheet.
- 2 Turn the function dial to air fry. Set the temperature to 425°F and the timer for 40 minutes.
- 3 Place of the cauliflower in the wire basket. Place the basket in position 3 and cook, turning occasionally, until the cauliflower is tender and lightly browned, 35 – 40 minutes.

BRAISED LAMB SHANKS WITH POTATOES AND ROSEMARY

Serves 4

Preparation Time: 20 min

Total Time: 1 hr 45 min

Ingredients:

Small Lamb shanks, about 2 lbs.	4
Kosher salt	1 1/4 tsp
Onion, finely chopped	1
Carrot, finely chopped	1
Celery rib, finely chopped	1
Garlic cloves, minced	2
Dry white wine	1/2 cup
Tomatoes, coarsely chopped	2
Chicken broth	1 cup
Baby white potatoes, left whole	1 lb
Chopped flat-leaf parsley	1 tbs
Grated lemon zest	1 tbs

Directions

1. Sprinkle the lamb shanks with 3/4 tsp salt. Heat the oil in large skillet over medium-high heat. Add the lamb and cook until browned on all sides, about 8 minutes; transfer to a 3-quart casserole dish. Add the onion, carrot, celery, and garlic to the skillet and cook, stirring occasionally, until the vegetables are tender, about 8 minutes.
2. Turn the function dial to bake. Turn the temperature to 325°F and preheat the oven. Place the rack in position 1.
3. Add the wine, tomatoes, broth, and remaining 1/2 tsp salt to the skillet and bring to a boil. Pour the wine mixture over the shanks in the casserole. Cover and place the casserole on a rack in position 1. Bake 1 hour 10 minutes. Add the potatoes and cook until the potatoes are tender and the lamb is fork-tender, about 20 minutes longer.
4. Skim fat from casserole. Sprinkle with the parsley and lemon zest just before serving.

PIZZA MARGHERITA WITH OLIVES

Serves 6

Preparation Time: 10 min

Total Time: 30 min

Ingredients:

Extra-virgin olive oil
Refrigerated pizza dough
Marinara sauce
Mozzarella cheese, cut into
1/4-inch-thick slices.
Kalamata olives, coarsely chopped

Quantity:

3 tbsp
15 oz pkg
1/2 cup
4 oz
8

Directions

1. Turn out the dough onto a lightly floured surface. With lightly floured hands, gently pull and stretch the dough into a 12-inch round. Transfer the dough to the pizza pan, gently pulling the dough back to the edges of the pan. Brush the top of the dough with 1 tablespoon olive oil.
2. Place the pizza in the oven in position 1. Select the pizza function and 12" diameter size. Press start/stop. The timer automatically sets for 19 minutes. During the last 6 minutes of baking time, the timer will beep indicating to add the sauce, cheese, olives, and red pepper flakes. Place in the oven in position 1 and bake until the cheese is melted, about 6 minutes. Sprinkle with the basil just before serving.

CHOCOLATE-NUT COOKIES

Serves 26 cookies

Preparation Time: 10 min

Total Time: 40 min

Ingredients:

Semi-sweet chocolate chips
Unsalted butter
Instant coffee powder
Vanilla extract
All-purpose flour
Baking powder
Salt
Sugar
Large eggs
Walnuts, coarsely chopped
Hazelnuts, coarsely chopped

Quantity:

8-oz
6 tbsp
1 tbsp
2 tsp
1/3 cup
1/2 tsp
1/2 tsp
3/4 cup
2
2 cups
1 cup

Directions

1. Turn the function selection dial to COOKIES and set 1TR. Press the START/STOP button (H).
2. Heat the chocolate chips, butter, and instant coffee in a

small saucepan over medium-low heat. Cook, stirring occasionally, until the chocolate is melted and smooth. Remove from the heat; stir in the vanilla. Cool 10 minutes.

3. Whisk together the flour, baking powder, and salt in a small bowl. Whisk together the sugar and eggs in a large bowl until the mixture is pale yellow and thickens slightly. Add the flour mixture and the chocolate mixture until just combined. Stir in the nuts.
4. Drop the mixture, by rounded tablespoons, and put half dough on the bake pan with baking paper and half dough on the pizza pan with baking paper.
5. When the temperature has been reached the oven will go into stand-by mode and the cooking time will flash on the display. Insert the bake pan in guide 2, set 14 minutes and press START/STOP button (H).
6. At the end, extract the bake pan, insert the pizza pan in guide 2, set 14 minutes and press START/STOP button (H).
7. Serve the cookies

LASAGNE ALLA BOLOGNESE

Serves 8

Preparation Time: 15 min

Total Time: 1 hr 6 min

Ingredients:

Olive oil
Onion, finely chopped
Garlic cloves, minced
Ground beef
Dry white wine
Marinara sauce
Unsalted butter
All-purpose flour
Milk
Salt
No-boil lasagna noodles
Grated Parmesan cheese

Quantity:

2 tbsp
1
2
1 lb
1/2 cup
24 oz jar
4 Tbs
1/4 cup
4 cups
1 1/2 tsp
9
6 tsp

Directions

1. To make the meat sauce, heat the oil in a large skillet over medium-high heat. Add the onion and garlic and cook, stirring until softened, about 5 minutes. Add the beef and cook, stirring to break it up with a spoon, until browned, about 5 minutes longer. Add the wine and cook until the wine is evaporated, about 2 minutes. Add the sauce and bring to a simmer. Cover and cook, stirring occasionally, until the sauce is thickened and the flavors are blended, about 15 minutes.
2. To make the white sauce, melt the butter in a medium saucepan over medium heat. Add the flour and cook, stirring con-

stantly, 1 minute. Add the milk and 1/2 tsp salt; bring to a boil. Reduce the heat and simmer, stirring occasionally, until the sauce thickens, about 8 minutes. Cover and set aside.

Turn the function dial to bake. Turn the temperature to 350°F and preheat the oven. Spray a 7x11 inch. baking dish with nonstick spray.

3. Spread 1 cup the white sauce on the bottom of the baking dish; top with 3 of the noodles. Top the noodles with 1 cup white sauce, 1 1/2 cups meat sauce and 2 tablespoons of Parmesan cheese. Repeat layering 2 more times, ending with the meat sauce. Sprinkle with the remaining Parmesan.
4. Place the baking dish on a rack in position 1 and bake, uncovered, until the filling is hot and the edges are browned and bubbly, about 45 minutes.

ROASTED COD TAPENADE

Serves 4

Preparation Time: 15 min

Total Time: 38 min

Ingredients:	Quantity:
Cod fillets	4 (6-oz)
Olive oil	3 tbsp
Kosher salt	1 tsp
Pepper	
Shallot, minced	1
Garlic clove, minced	1
Cherry tomatoes, halved	2 cups
Kalamata olives, coarsely chopped	1/3 cup
Capers	1 tbsp
Chopped fresh thyme	2 tsp
Red pepper flakes	1/4 tsp

Directions

1. Turn the function dial to convection. Turn the temperature to 425°F and preheat the oven. Line the baking tray with foil.
2. Rub the fillets with 2 tsp oil and sprinkle with 1/2 tsp salt and 1/4 tsp pepper. Place the fillets on the baking tray in position 1 and roast until the fish is opaque throughout, 12 - 15 minutes.
3. Meanwhile, heat the remaining 2 Tbs oil in a medium skillet over medium-high heat. Add the shallot and garlic and cook, stirring occasionally, until tender, 1 - 2 minutes. Add the tomatoes, olives, capers, thyme, pepper flakes and the remaining 1/2 tsp salt. Cook, stirring occasionally, until the tomatoes are softened, about 8 minutes. Serve spooned over the cod.

JAM TART

Serves 8

Preparation Time: 15 min

Total Time: 45 min

Ingredients:

Unsalted butter, softened	1 cup (2 sticks)
sugar	1/2 cup + 2 tbsp
Large egg	1
Vanilla extract	1 tsp
All-purpose flour	2 1/2 cups
Salt	1 tsp
Apricot jam	12-oz jar
Lemon juice	1 tbsp
Milk	3 tbsp

Quantity:

Directions

1. Turn the function dial to bake. Turn the temperature to 360°F and preheat the oven.
2. With a mixer at medium speed, beat the butter and sugar in a large bowl until blended. Increase the speed to high, and beat until light and fluffy. Reduce the speed to medium. Beat in the egg and vanilla. Stir in the flour and salt until mixture is crumbly. Gather the dough into a ball. Divide the dough into two pieces, one slightly larger than the other. Wrap and refrigerate the smaller disk of dough.
3. Press the larger piece of dough onto the bottom and up the sides of an 11-inch tart pan with a removable bottom. Whisk together the jam and lemon juice in a small bowl. Spread the jam mixture evenly over the dough.
4. On a lightly floured surface, roll out the smaller disk of dough to a 12-inch round. Cut the round into 10 strips. Place half of the the dough strips, 1 inch apart, across the tart, trimming ends even with side of tart pan. Place the remaining strips diagonally across to make a lattice pattern. Brush the strips with milk and sprinkle with the remaining 2 Tbs sugar.
5. Place the tart on the rack in position 2 and bake until the crust is golden, about 35 minutes. Cool in pan on a rack at least 30 minutes. Carefully remove side of pan from cooled tart.