



电 烤 箱

ELECTRIC OVEN

使 用 说 明 书



EO14902.S

目 录

机器的描述	2
功能	2
温控指示灯	2
机器的废旧处理	3
首次使用机器	4
传统烘烤功能	5
保温功能	6
烤架烧烤	7
对流式烘烤	8
解冻功能	9
披萨	10
清洁	11
烤箱食谱	12

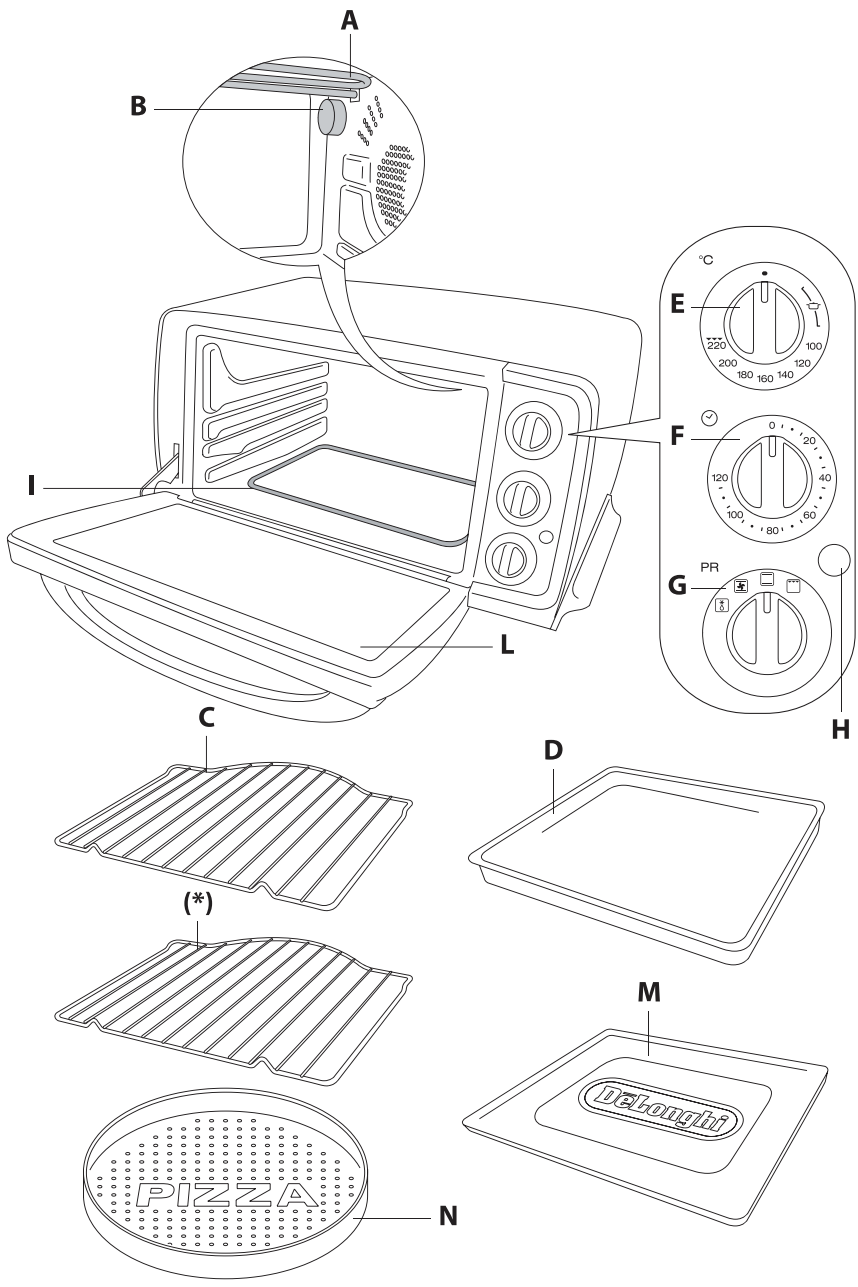

机器的描述

- A、顶部加热管
- B、烤箱内照明（仅限特定型号）
- C、烤架（*）（仅限特定型号）
- D、烤盘（仅限特定型号）
- E、温控旋钮
- F、定时旋钮
- G、功能选择旋钮
- H、温控指示灯
- I、底部加热管
- L、烤箱的玻璃门
- M、残屑盘
- N、披萨盘（仅限特定型号）

功能



烤架烧烤，适用于烤架烘烤食物



传统烘烤功能，适用于各种类型的传统烘烤



解冻功能，用于各种食物的解冻（仅限特定的型号）



对流式烘烤，适用于快速烘烤（仅限特定的型号）



保温功能，适用于食物的保温



小贴士：更多烘烤功能和烘烤菜谱的信息，详见说明书12-13页的内容。

温控指示灯

当开启机器时，温控指示灯（H）亮起；当达到设定的烘烤温度时，温控指示灯（H）熄灭。

重要的安全警告

在使用机器前，请仔细地阅读此说明书，并保存好。



小贴士：

重要的建议或信息会用这些符号标出。

- 首次使用本机器前，请取出里面所有的纸和其他包装材料，如硬纸板、小册子、塑料袋等等。
- 机器放置的位置与连接的插座之间至少要有20厘米的距离。
- 首次使用本机器前，将温控旋钮旋转至最高温度值空运行至少20分钟，以消除

“新”的气味或在运输前电热管上的保护物质所发出的烟。在这项操作时，房间必须保持通风。

- 使用前请清洗所有的配件。
- 切勿使用具有腐蚀性或酸性的洗涤剂来清洗烤箱的内部及配件。
- 如果烘烤的时间少于20分钟，首先将定时旋钮旋转到底，然后再将定时旋钮旋转至所需的时间。
- 为避免可能出现的电击，更换灯泡前请先确认机器已断开电源。



重要！

不遵守这些警告有可能会造成人身伤害或损坏机器。

- 本机器只能用于烘烤食物，不能用作其他用途或者用任何方式进行改装。
- 在打开包装前，请先确认烤箱的门完好无损，且能正常工作。

烤箱门是玻璃材质的，较易碎。如果有明显的碎裂、划痕或刮痕，请务必更换。在使用、清洁或移动机器过程中，切勿猛烈的撞击烤箱门。当烤箱还是热的时候，切勿在烤箱门上倾倒冷的液体。

- 将烤箱放置在至少离地85厘米的水平面上，并不要让孩童接触。

• 本机器不适用于在身体、知觉及精神方面受损的人士或缺乏经验和相关知识的人士（包括孩童）使用，除非在有人监管确保安全的情况下，切勿让孩童使用本机器，除非他们已获得相关监督或指导使用本产品。

切勿让儿童进行清洁或保养机器，除非他们8岁以上，且在有人监督的情况下进行。

- 机器和电源线需远离8岁以下的儿童放置。
- 在使用时切勿移动本机器。
- 在以下情况下切勿使用本机器：
 - 机器电源线损坏。
 - 机器有被摔过，有明显的损坏或故障。

在这种情况下，为了避免危险，请与最近的授权的售后服务中心联系。

- 切勿将机器放置在热源附近。
- 切勿将机器当作热源。
- 不要把纸、木板或塑料东西放在烤箱里面，也不要放在机器顶部放任何东西，如器具、烤架或其他物品。

- 不要塞入物体阻塞通风口，要确保畅通无阻。
- 本机器不可嵌入式安装。
- 切勿将重物或将热的盘子或容器放在打开的门上。切勿往下拉手柄。
- 若用作专业用途、不恰当使用本机器或不按操作说明使用本机器造成的损坏，制造商不承担任何的责任。
- 本机器仅仅为家用电器，并不适用于以下场所：商场的员工餐厅，办公室或其他工作环境；牧场旅馆；旅馆、汽车旅馆或其他住宅性环境的住客；家庭式旅馆。
- 在进行清洁前，请先拔出电源插头。
- 本机器不可使用外接定时器或单独的控制装置。
- 本机器必须靠墙放置和操作。
- 在进行清洁之前，请先将设置时间旋钮旋转到“0”的位置，然后关闭机器，并拔出电源插头。
- 切勿用尖的或锋利的金属物体来清洁烤箱及配件。



烫伤危险！

不遵守这些警告有可能导致烫伤危险。

- 当机器运转时烤箱门或周围的表面都会变得很热，切勿碰触金属或玻璃部分，只能碰触旋钮、手柄及按钮。若有必要请使用烤箱手套。
- 本机器工作时产生高温，可能会导致燃烧。
- 切勿将易燃物体放置在本机器附近或工作台下面。
- 切勿在吊柜、碗柜下或易燃材料附近(如窗帘、百叶窗等等)操作机器。
- 若是食物或烤箱其他部件着火了，切勿用水来灭火。关闭烤箱门，拔掉电源，然后用一块潮湿的布来灭火。



危险！

不遵守这些警告有可能导致人身伤害或触电危险。

- 机器接通电源前，请确认：
 - 所使用的电源电压是否与产品铭牌标示是否一致。
 - 电源插座安装有效接地线，且电源插座最小电流为10安培。

由于未按说明书操作机器而产生的一切后果，制造商不负任何责任。

- 切勿悬挂电源线，避免电源线接触到烤箱的发热部分。切勿用拽拉的方式拔电源线。
- 若要使用延伸线，必须确保接通地线，所用的电线规格与机器提供的电源线一致。
- 为了避免触电危险，切勿将电源线、插头及机器浸入水中。
- 如果电源线损坏了，必须由制造商或被授权的服务中心或专业人员进行更换，以避免危险。
- 为了您自身的安全，请不要自行拆卸机器，请与售后服务中心联系。

机器的废旧处理

根据欧盟有关2002/96/EC的指令，当机器废弃时不能按一般的家电进行废旧处理，需将机器交给专门的分类垃圾收集中心进行处理。



首次使用机器

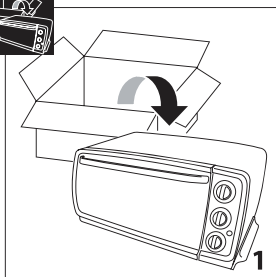

1、从包装中取出机器

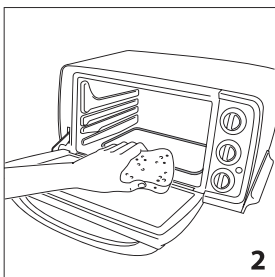

2、用一块海绵清洁烤箱的内部

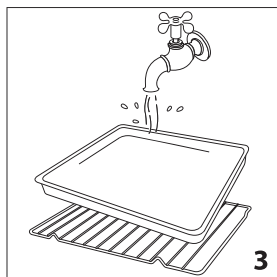

3、用流动地水清洗烤箱的配件

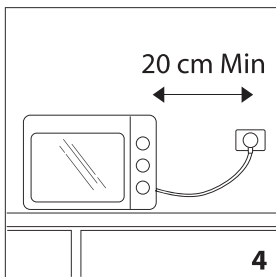

4、烤箱放置的位置与插座之间至少20厘米

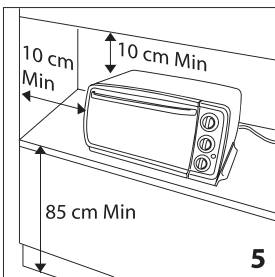

5、烤箱放置的位置离地至少85厘米，左边和背后离墙至少10厘米

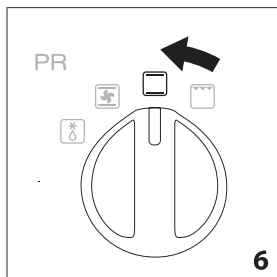

6、将功能选择旋钮旋转至如图所示的位置

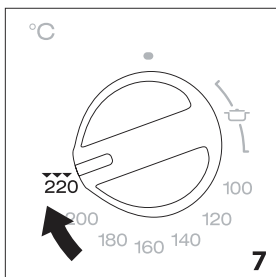

7、将温控旋钮旋转至如图所示的位置

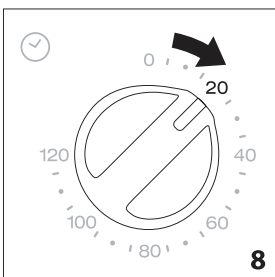

8、将定时旋钮旋转至如图所示的位置

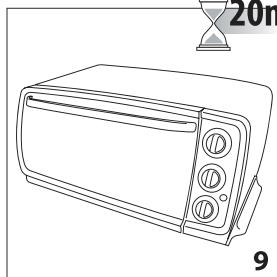

9、关闭烤箱门，烘烤20分钟

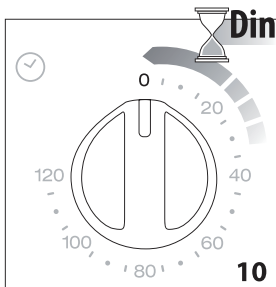

10、当达到烘烤时间时，烤箱会发出“叮”的提示音

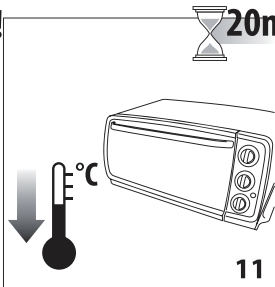

11、等待20分钟，待烤箱冷却

传统烘烤功能

进行烘烤前请将烤箱预热5-10分钟

烘烤时请放入残屑盘

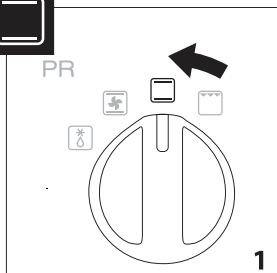

1、将功能选择旋钮旋转至如图所示的位置

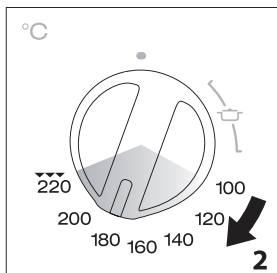

2、将温控旋钮旋转至如图所示的位置，具体参考烤箱食谱

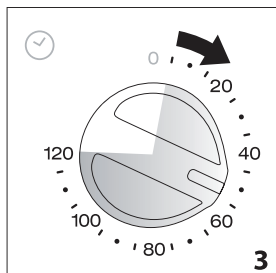

3、将定时旋钮旋转至如图所示的位置，具体参考烤箱食谱

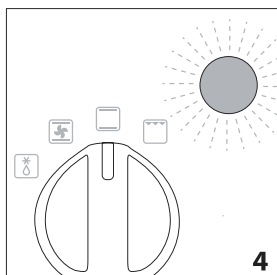

4、烤箱的温控指示灯亮起

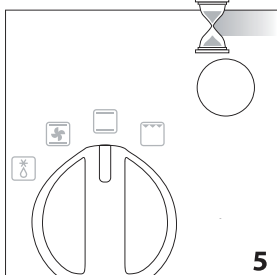

5、等待烤箱的温控指示灯熄灭

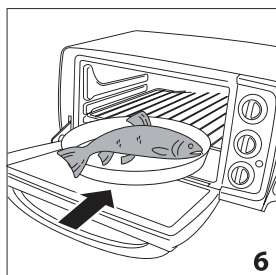

6、将需要烘烤的食物放入烤箱

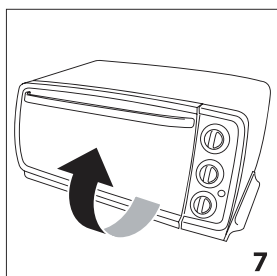

7、关上烤箱门

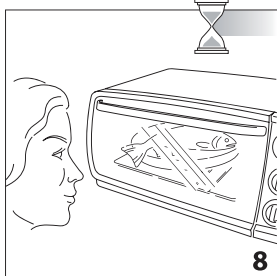

8、随时观察食物的烘烤情况

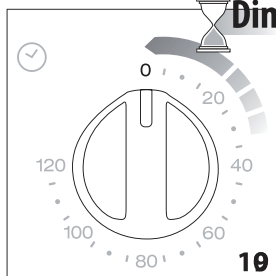

9、当达到烘烤时间时，烤箱会发出“叮”的提示音

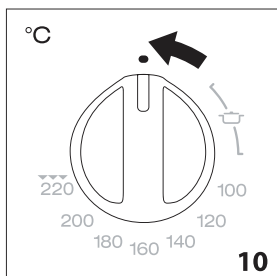

10、将温控旋钮旋转至如图所示的位置

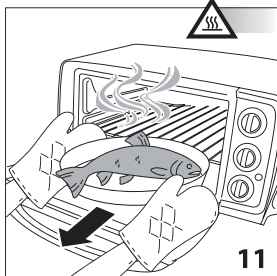

11、打开烤箱的门，戴上隔热手套取出烘烤好的食物
注意小心烫伤

保温功能

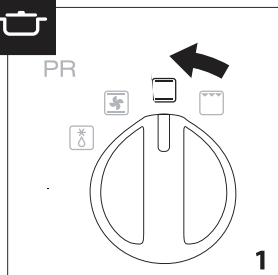

1、将功能选择旋钮旋转至如图所示的位置

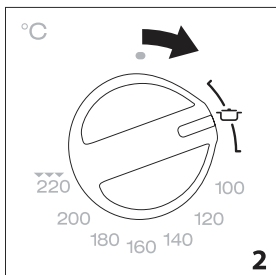

2、将温控旋钮旋转至如图所示的位置

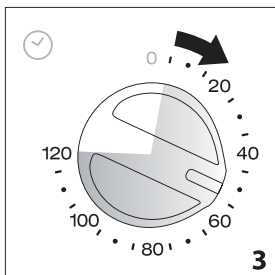

3、将定时旋钮旋转至如图所示的位置,具体根据所需的时间而定

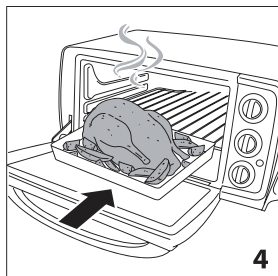

4、将烤架及需要烘烤的食物放进烤箱

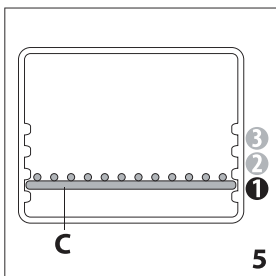

5、将烤架放置在如图所示的位置

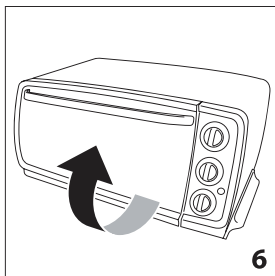

6、关上烤箱的门

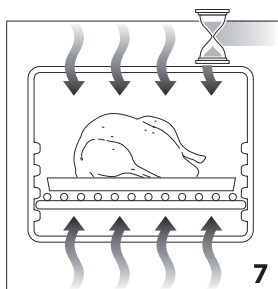

7、食物保温中

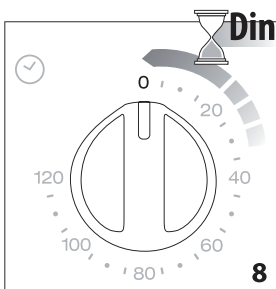

8、当达到烘烤时间时,烤箱会发出“叮”的提示音

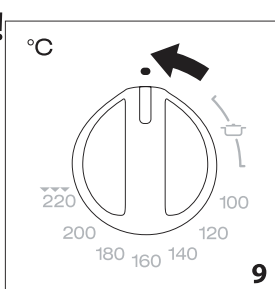

9、将温控旋钮旋转至如图所示的位置

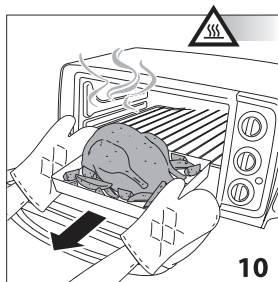

10、打开烤箱的门,戴上隔热手套取出烘烤好的食物
注意小心烫伤

烤架烧烤

进行烘烤前请将烤箱预热5-10分钟
烘烤时请放入残屑盘

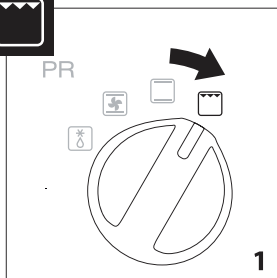

1、将功能选择旋钮旋转至如图所示的位置

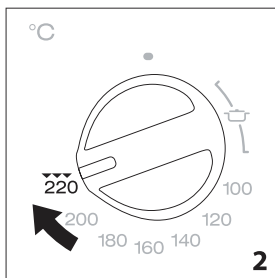

2、将温控旋钮旋转至如图所示的位置

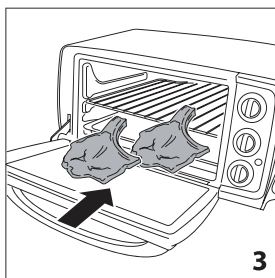

3、将烤架及需要烘烤的食物放进烤箱

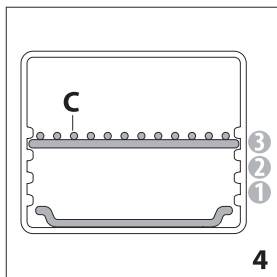

4、将烤架放置在如图所示的位置

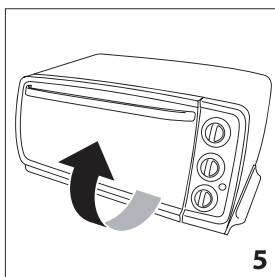

5、关上烤箱的门

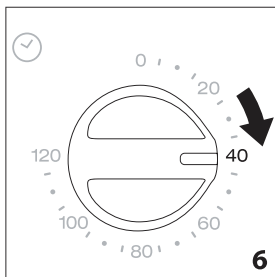

6、将定时旋钮旋转至如图所示的位置，具体可参考烤箱食谱

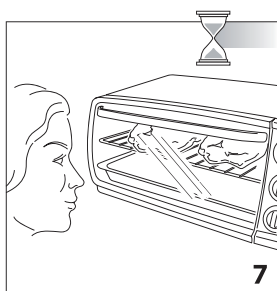

7、随时观察食物的烘烤情况

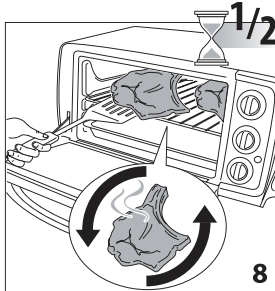

8、烘烤到一半时，取出食物翻一下

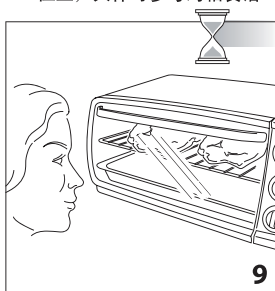

9、继续观察食物的的烘烤情况

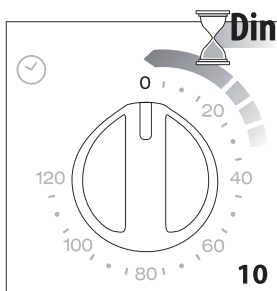

10、当达到烘烤时间时，烤箱会发出“叮”的提示音

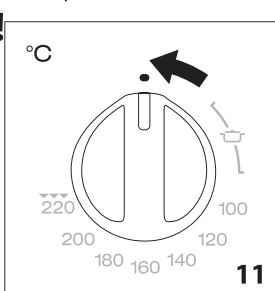

11、将温控旋钮旋转至如图所示的位置

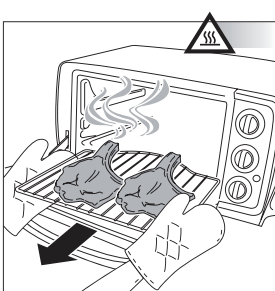

12、打开烤箱的门，戴上隔热水套取出烘烤好的食物
注意小心烫伤

对流式烘烤

进行烘烤前请将烤箱预热5-10分钟

烘烤时请放入残屑盘

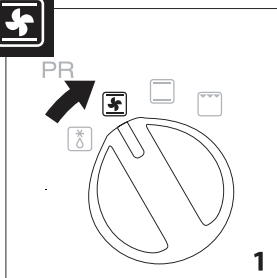

1、将功能选择旋钮旋转至如图所示的位置

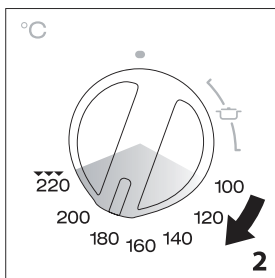

2、将温控旋钮旋转至如图所示的位置，具体参考烤箱食谱

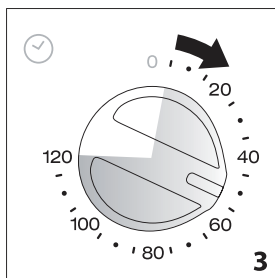

3、将定时旋钮旋转至如图所示的位置，具体可参考烤箱食谱

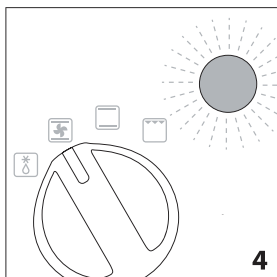

4、烤箱的温控指示灯亮起

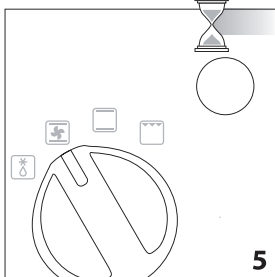

5、等待烤箱的温控指示灯熄灭

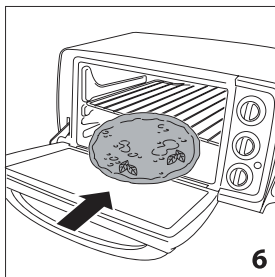

6、将需要烘烤的食物放入烤箱，烤架的位置参考烤箱食谱

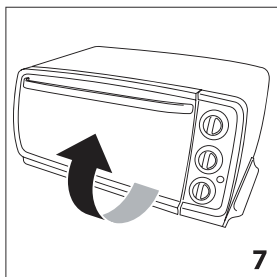

7、关上烤箱门

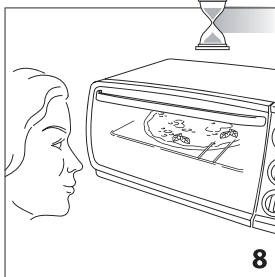

8、随时观察食物的烘烤情况

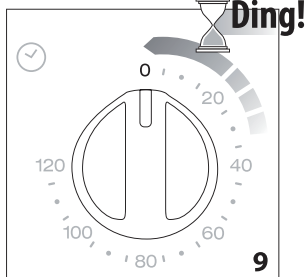

9、当达到烘烤时间时，烤箱会发出“叮”的提示音

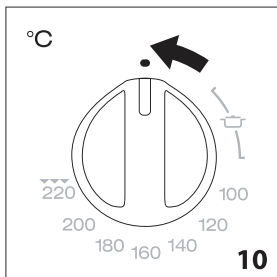

10、将温控旋钮旋转至如图所示的位置

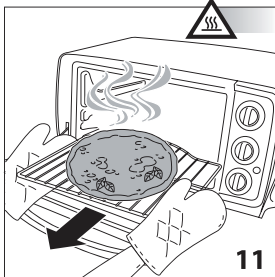

11、打开烤箱的门，戴上隔热手套取出烘烤好的食物
注意小心烫伤

解冻功能

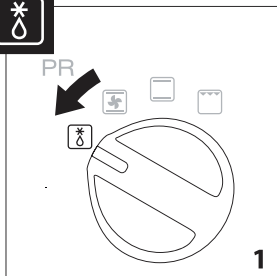

1、将功能选择旋钮旋转至如图所示的位置，具体参考烤箱食谱

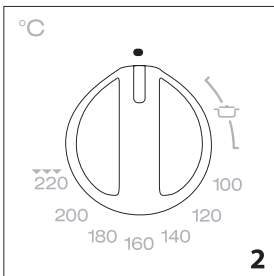

2、将温控旋钮旋转至如图所示的位置

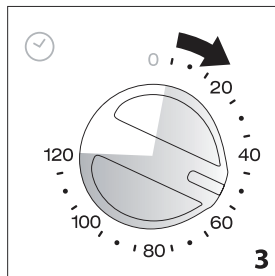

3、将定时旋钮旋转至如图所示的位置

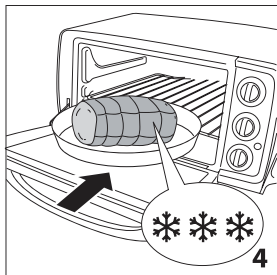

4、将需要解冻的食物放进烤箱

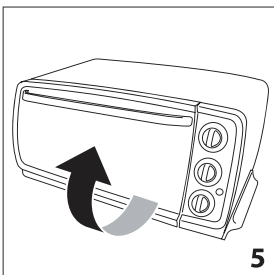

5、关上烤箱的门

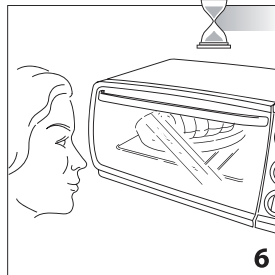

6、随时察食物的解冻情况

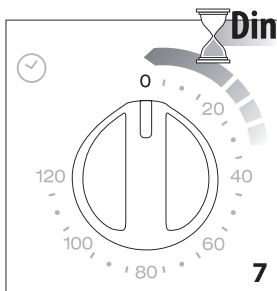

7、当达到烘烤时间时，烤箱会发出“叮”的提示音

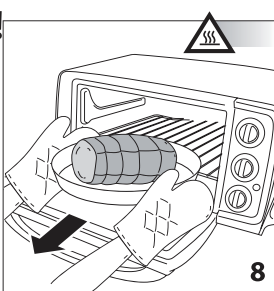

8、打开烤箱的门，取出解冻好的食物

披萨

进行烘烤前请将烤箱预热5-10分钟
烘烤时请放入残屑盘

Pizza

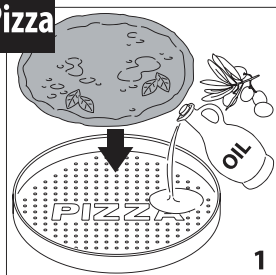

1、在披萨盘上倒少量的油抹匀

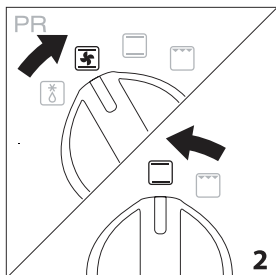

2、将功能选择旋钮旋转至如图所示的位置

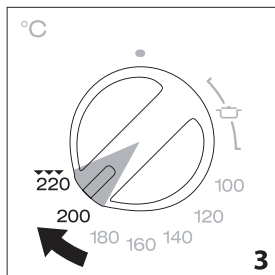

3、将温控旋钮旋转至如图所示的位置，具体参考烤箱食谱

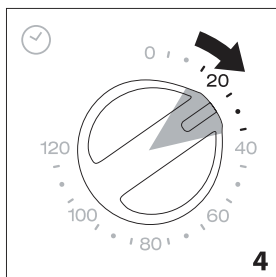

4、将定时旋钮旋转至如图所示的位置，具体参考烤箱食谱

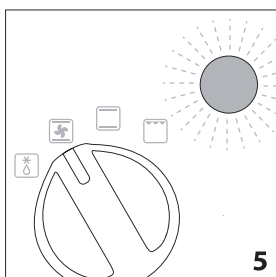

5、烤箱的温控指示灯亮起

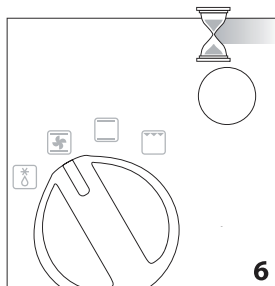

6、等待烤箱的温控指示灯熄灭

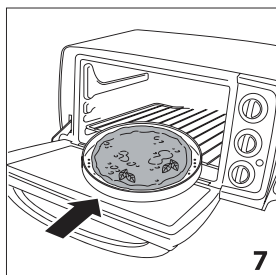

7、将烤架及需要烘烤的披萨放入烤箱

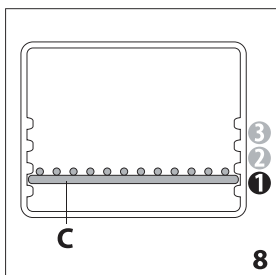

8、将烤架放置在如图所示的位置

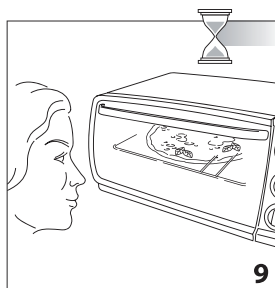

9、随时观察食物的烘烤情况

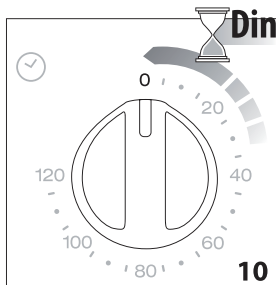

10、当达到烘烤时间时，烤箱会发出“叮”的提示音

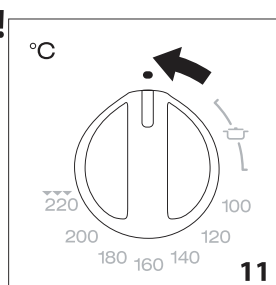

11、将温控旋钮旋转至如图所示的位置

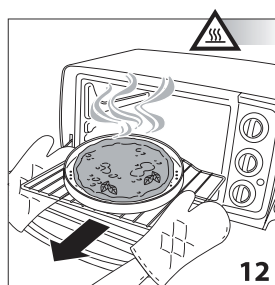

12、打开烤箱的门，戴上隔热手套取出烘烤好的食物
注意小心烫伤

清洁

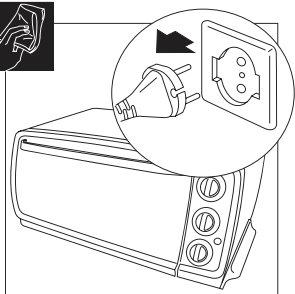

1、拔下机器的电源插头

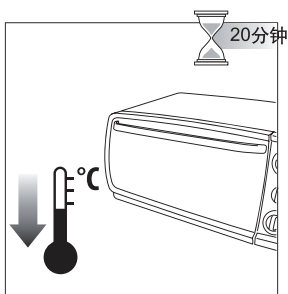

2、等待20分钟，待烤箱冷却

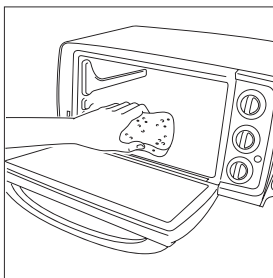

3、用一块海绵清洁烤箱的内部

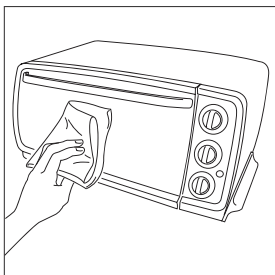

4、用一块潮湿的抹布清洁烤箱的外部

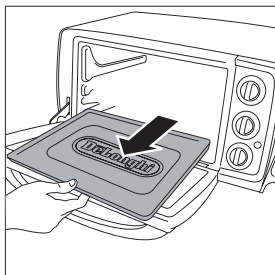

5、打开烤箱的门，取出残屑盘

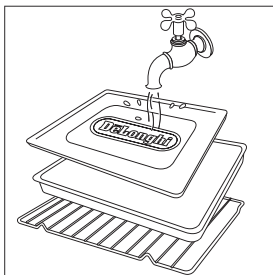

6、用流动的水清洗所有的配件

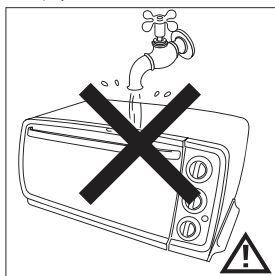

7、切勿用流动地水冲洗烤箱

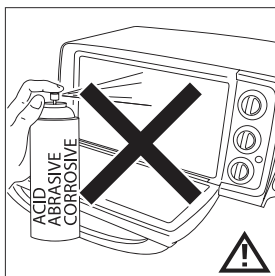

8、切勿用具有酸性的、研磨性的或腐蚀性的洗涤剂清洗烤箱

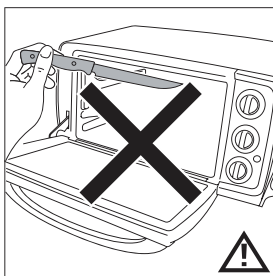



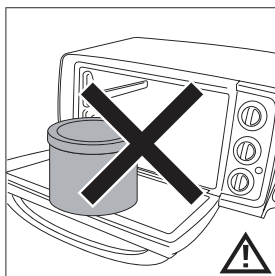







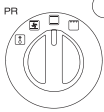



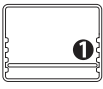



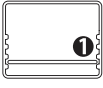



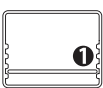



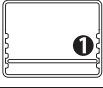

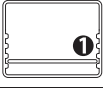

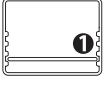



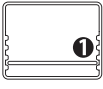

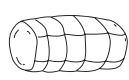
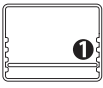



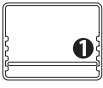

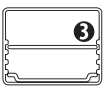











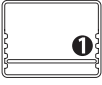



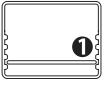

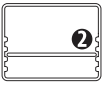





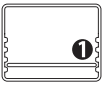





9、切勿用刀片刮擦烤箱

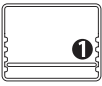

10、切勿将重物放置在烤箱的门上

烤箱食谱

					
	700克		 	180 °C	40-45 分钟 35-40 分钟
Pizza 	750克		 	220 °C	28-33 分钟 22-27 分钟
Pizza  ***	450克		 	200 °C	20-25 分钟 15-20 分钟
	500克			180 °C	35-40 分钟
	1500克			180 °C	35-40 分钟
	1300克		 	190 °C	100-105 分钟 80-85 分钟
	1200克		 	200 °C	70-75 分钟 60-65 分钟
	1000克		 	190 °C	90-95 分钟 75-80 分钟
	800克			180 °C	40-45 分钟
	2			220 °C	25-30 分钟

	1000 克			200 °C	25-30 分钟
	1000 克			200 °C	60-65 分钟
***					50-55 分钟
	1000 克			200 °C	60-65 分钟
					55-60 分钟
	1000 克			200 °C	20-25 分钟
	300 克			180 °C	15-20 分钟
	6			180 °C	15-18 分钟
***					13-15 分钟
	850 克			180 °C	35-40 分钟
					30-35 分钟
	850 克			180 °C	35-40 分钟
					25-30 分钟
	900 克			180 °C	30-35 分钟
	12			170 °C	30-35 分钟
					25-30 分钟
	900 克			160 °C	85-90 分钟

DESCRIPTION OF APPLIANCE

- A Top heating element
- B Inside light (certain models only)
- C Wire rack – (*) Certain models only
- D Bake pan (certain models only)
- E Thermostat dial
- F Timer dial
- G Function selector dial
- H Thermostat light
- I Bottom heating element
- L Glass door
- M Crumb tray
- N Pizza plate (certain models only)

TECHNICAL DATA

Voltage: 220-240 V ~ 50/60Hz

Absorbed power: 1400 W

Size LxHxD: 490 x 235 x 370 mm

Weight: 8.3 kg

FUNCTIONS



GRILL FUNCTION ideal for grilling food



TRADITIONAL OVEN FUNCTION ideal for all types of traditional cooking



DEFROSTING FUNCTION ideal for defrosting all products (certain models only)



CONVECTION ideal for quicker more even cooking (certain models only)



KEEPING FOOD WARM



Please note: For more information regarding the various functions and cooking tables, refer to the images on page 4-13.

THERMOSTAT LIGHT

The thermostat light (H) lights when the oven is on and turns off when the oven reaches the set temperature.

IMPORTANT SAFEGUARDS

Read all the instructions carefully before using the appliance. Keep these instructions.



Please note:
This symbol identifies important advice or information for

the user.

- Before using the oven for the first time, remove any paper and other material inside the oven such as protective cardboard, booklets, plastic bags, etc.
- The appliance must be kept at a distance of at least 20 cm from the mains power socket to which it is connected.
- Before using for the first time, operate the oven empty with the thermostat at maximum for at least 20 minutes to eliminate the “new” smell and any smoke caused by the presence of protective substances applied to the heating elements before transport. Ventilate the room.
- Wash all accessories before use.
- Never use corrosive or acid or aggressive detergent to clean the oven cavity or the accessories.
- To set times less than 20 minutes, first turn the timer dial all the way to the end and then position it on the desired time.



Important!

Failure to observe the warning could result in injury or damage to the appliance.

- This oven is designed to cook food. It must never be used for other purposes, modified or tampered with in any way.
- After unpacking the appliance, make sure the door is undamaged and working correctly. The door is made from glass and is therefore fragile. If it is visibly chipped, scored or scratched, it should be replaced. While using, cleaning or moving the appliance, avoid slamming or knocking the door violently. Do not pour cold liquid onto the glass while the appliance is hot.
- Place the appliance on a horizontal surface at a height of at least 85 cm and out of reach of children.
- This appliance can be used by children aged from 8 years and above and persons with reduced physical, sensory or mental capabilities or lack of experience and knowledge if they have been given supervision or instruction concerning use of the appliance in a safe way and understand the hazards involved. Children should be supervised to ensure that they do not play

with the appliance.

Cleaning and user maintenance shall not be made by children, unless they are more than eight years old and under constant supervision.

- Keep the appliance and power cable away from children under eight years of age.

- Do not move the appliance while in use.
- Do not use the appliance if:
 - The power cable is faulty
 - The appliance has been dropped, is visibly damaged or malfunctioning.

In these cases, to avoid all risk take the appliance to your nearest authorised customer services.

- Never position the appliance near heat sources.
- Do not use the appliance as a heat source.
- Never place paper, cardboard or plastic inside the oven and never rest anything on top of the appliance (utensils, wire racks, other objects).
- Never insert anything into the ventilation openings. Make sure they are unobstructed.
- This oven is not designed for built-in installation.
- Do not rest heavy objects, boiling pans or containers on the open door.
Do not pull the handle downwards.

- Professional or inappropriate use, or failure to observe the instruction for use absolves the manufacturer from all responsibility and invalidates the guarantee.

- This is a household appliance only.

It is not intended to be used in: staff kitchen areas in shops, offices and other working environments, farm houses, hotels, motels and other residential type environments, bed and breakfast type environments.

- When not in use and before cleaning, always unplug the appliance.
- This appliance must not be operated

by a timer or a separate remote control system.

- The appliance must be placed and operated with the back next to the wall.
- Before cleaning, always turn the appliance off by setting the timer to "0" and unplugging it from the mains socket.

Danger of burns!

Failure to observe the warning could result in scalds or burns.

- When in operation, the door and accessible external surfaces could become very hot. Always use the knobs, handles and buttons. Never touch metal parts or the glass. Use oven gloves if necessary.
- This electrical appliance operates at high temperatures which could cause burns.
 - Do not leave inflammable products near the oven or under the work surface where it is located.
 - Never operate the appliance under a wall cupboard or shelf or near inflammable materials such as curtains, blinds, etc.
 - **If food or other parts of the oven catch fire, never try and put out the flames with water. Close the door, unplug from the mains and smother the flames with a damp cloth.**

Danger!

Failure to observe the warning may result in life threatening injury by electric shock.

- **Before plugging into the mains, make sure that:**
 - **The mains voltage corresponds to the voltage indicated on the rating plate.**
 - **the mains socket is earthed and has a minimum rating of 16A.**

The manufacturer declines all liability in the event that this important accident-prevention rule is not respected.

- Do not let the power cable dangle and avoid touching hot parts of the oven.
Never unplug the appliance by pulling on the power cable.

- If you intend to use an extension, make sure it is in good condition, that the plug is earthed and that the cross section of the wires is at least equal to that of the power cable provided with the appliance.
- To avoid all risk of electric shock, never immerse the power cable, plug or appliance itself in water.
- If the power cable is damaged, it must be replaced by the manufacturer, the manufacturer's customer services or a qualified electrician in order to eliminate all risk.
- For your personal safety, never take the appliance to pieces on your own. Always contact customer services.

CE The appliance complies with the following EU directives:

- Low Voltage Directive 2006/95/EC and subsequent amendments;
- EMC Directive 2004/108/EC and subsequent amendments;
- Materials and accessories coming into contact with food conform to European regulation (EC) no. 1935/2004.

DISPOSAL

In compliance with European directive 2002/96/EC, the appliance must not be disposed of with household waste, but taken to an authorised waste separation and recycling centre.



ELECTRICAL CONNECTION (UK ONLY)

- A) If your appliance comes fitted with a plug, it will incorporate a 13 Amp fuse. If it does not fit your socket, the plug should be cut off from the mains lead, and an appropriate plug fitted, as below.

WARNING: Very carefully dispose of the cut off plug after removing the fuse: do not insert in a 13 Amp socket elsewhere in the house as this could cause a shock hazard.

With alternative plugs not incorporating a fuse, the circuit must be protected by a 15 Amp fuse. If the plug is a moulded-on type, the fuse cover must be re-fitted when changing the fuse using a 13 Amp Asta approved

fuse to BS 1362. In the event of losing the fuse cover, the plug must NOT be used until a replacement fuse cover can be obtained from your nearest electrical dealer. The colour of the correct replacement fuse cover is that as marked on the base of the plug.

- B) If your appliance is not fitted with a plug, please follow the instructions provided below:

WARNING - THIS APPLIANCE MUST BE EARTHED IMPORTANT

The wires in the mains lead are coloured in accordance with the following code:

Green and yellow:	Earth
Blue:	Neutral
Brown:	Live



As the colours of the wires in the mains lead may not correspond with the coloured markings identifying the terminals in your plug, proceed as follows:

The green and yellow wire must be connected to the terminal in the plug marked with the letter E or the earth symbol  or coloured green or green and yellow.

The blue wire must be connected to the terminal marked with the letter N or coloured black.

The brown wire must be connected to the terminal marked with the letter L or coloured red.



★若有任何需求请与下述地址联系：

☆ 邑隆贸易(上海)有限公司

地址：上海市中山北路3553号伸大厦2001-2016室

电话：(021) 3135 8858 传真：(021) 3135 8262 邮编：200062

客户热线：400 827 1668 网址：www.delonghi.com.cn