

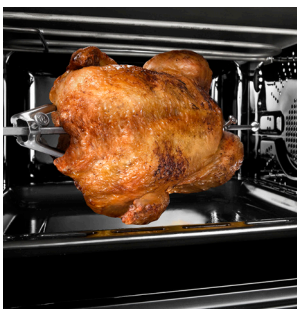

De'Longhi Appliances
via Seitz, 47
31100 Treviso Italia

Instructions for use ELECTRIC OVEN



electrical connection (uk only)

- A) If your appliance comes fitted with a plug, it will incorporate a 13 Amp fuse. If it does not fit your socket, the plug should be cut off from the mains lead, and an appropriate plug fitted, as below.

WARNING: Very carefully dispose of the cut off plug after removing the fuse: do not insert in a 13 Amp socket elsewhere in the house as this could cause a shock hazard.

With alternative plugs not incorporating a fuse, the circuit must be protected by a 15 Amp fuse. If the plug is a moulded-on type, the fuse cover must be re-fitted when changing the fuse using a 13 Amp Asta approved fuse to BS 1362. In the event of losing the fuse cover, the plug must NOT be used until a replacement fuse cover can be obtained from your nearest electrical dealer. The colour of the correct replacement fuse cover is that as marked on the base of the plug.

- B) If your appliance is not fitted with a plug, please follow the instructions provided below:

WARNING - THIS APPLIANCE MUST BE EARTHED

IMPORTANT

The wires in the mains lead are coloured in accordance with the following code:

Green and yellow: Earth
Blue: Neutral
Brown: Live

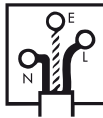

As the colours of the wires in the mains lead may not correspond with the coloured markings identifying the terminals in your plug, proceed as follows:

The green and yellow wire must be connected to the terminal in the plug marked with the letter E or the earth symbol  or coloured green or green and yellow.

The blue wire must be connected to the terminal marked with the letter N or coloured black.

The brown wire must be connected to the terminal marked with the letter L or coloured red.

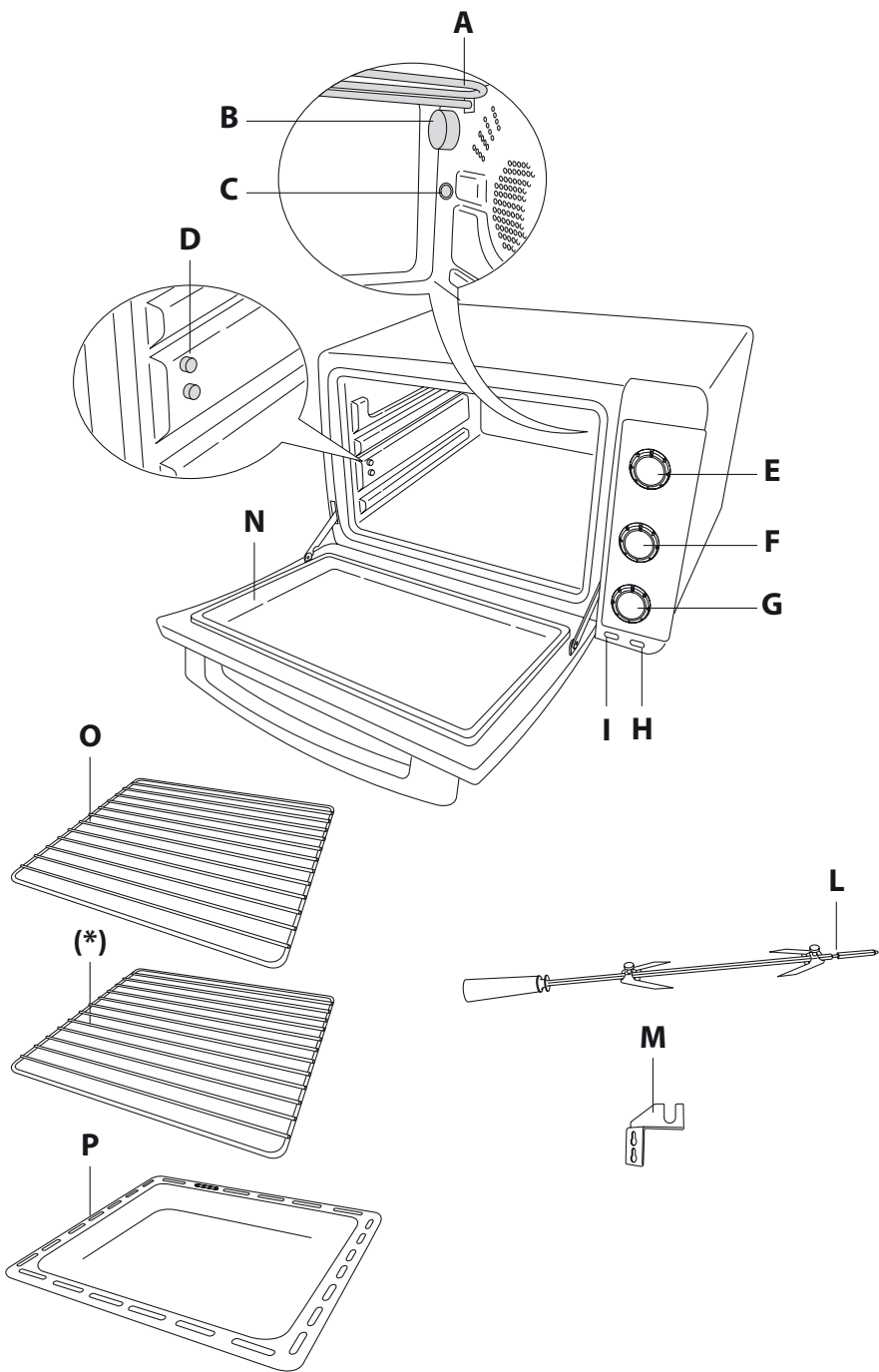

description - important safeguards **en**

Description of appliance

- A Top element
- B Internal light (certain models only)
- C Spit roast housing (certain models only)
- D Spit support hooks (certain models only)
- E Thermostat dial
- F Timer dial
- G Mode selector
- H Green °C light
- I Red ON light
- L Spit (certain models only)
- M Spit support (certain models only)
- N Glass door
- O Wire rack - (*) certain models only
- P Drip pan

Technical specification









Voltage: 220-240 V ~ 50/60Hz max 16A

Absorbed power: 2000 W o 2200 W



Size LxHxP: 530 x 340 x 450

Weight: 14.5 kg

Functions

-  SPIT ROAST FUNCTION ideal for spit roasting (*certain models only*)
-  GRATIN FUNCTION ideal for browning food (*certain models only*)
-  GRILL FUNCTION ideal for grilling food
-  TRADITIONAL OVEN FUNCTION ideal for all types of traditional cooking
-  DEFROSTING FUNCTION ideal for defrosting all products (*certain models only*)
-  HEAT CONVECTION ideal for quicker more even cooking (*certain models only*)
-  FAN FUNCTION ideal for more even cooking (*certain models only*)
-  KEEPING FOOD WARM (70°C-80°C)

Indicator lights

- ON  the red ON light comes on when the oven is on
-  the green °C light comes on when the oven reaches

the required temperature

Read all the instructions carefully before using the appliance. Keep these instructions

Please note:

This symbol identifies important advice or information for the user.

- Before using the oven for the first time, remove any paper and other material inside the oven such as protective cardboard, booklets, plastic bags, etc.
- The appliance must be kept at a distance of at least 20 cm from the mains power socket to which it is connected.
- Before using for the first time, operate the oven empty with the thermostat at maximum for at least 15 minutes to eliminate the “new” smell and any smoke caused by the presence of protective substances applied to the heating elements before transport.
Ventilate the room.
- Wash all accessories thoroughly before use.

Important!

Failure to observe the warning could result in injury or damage to the appliance.

- This oven is designed to cook food.
It must never be used for other purposes, modified or tampered with in any way.
- When you have unpacked the appliance, make sure the door is undamaged and working correctly.
The door is made from glass and is therefore fragile. If it is visibly chipped, scored or scratched, it should be replaced. While using, cleaning or moving the appliance, avoid slamming or knocking the door violently. Do not pour cold liquid onto the glass while the appliance is hot.
- Place the appliance on a horizontal surface at a height of at least 85 cm and out of reach of children.
- This appliance can be used by children aged from 8 years and above and persons with reduced physical, sensory or mental capabilities or lack of experience and knowledge if they have been given supervision or instruction concerning use of the appliance in a safe way and understand the hazards involved.

Children should be supervised to ensure that they do not play with the appliance.

Cleaning and user maintenance shall not be made by children, unless they are more than eight years old and under constant supervision.

- Keep the appliance and power cable away from children under eight years of age.
 - Do not move the appliance while in use.
 - Do not use the appliance if:
 - The power cable is faulty
 - the appliance has been dropped, is visibly damaged or malfunctions. In these cases, to avoid all risk take the appliance to your nearest authorised customer services.
 - Never position the appliance near heat sources.
 - Do not use the appliance as a heat source.
 - Never place paper, cardboard or plastic inside the oven and never rest anything on top of the appliance (utensils, wire racks, other objects).
 - Never insert anything into the ventilation openings. Make sure they are unobstructed.
 - This oven is not designed for built-in installation.
 - Do not rest heavy objects, boiling pans or containers on the open door.
 - Do not pull the handle downwards.
 - Professional or inappropriate use, or failure to observe the instructions absolves the manufacturer from all responsibility and invalidates the guarantee.
- This is a household appliance only. It is not intended to be used in: in staff kitchen areas in shops, offices and other working environments; farm houses; by clients in hotels, motels and other residential type environments; bed and breakfast type environments.
 - When not in use and before cleaning, always unplug the appliance.
 - The appliance must not be operated by

a timer or a separate remote control system.

- The appliance must be placed and operated with the back next to the wall.
- Do not use pointed or sharp metal objects to clean the bread pan.
- Before cleaning, always turn the appliance off by setting the timer to "0" and unplugging it from the mains socket.

Danger of burns!

Failure to observe the warning could result in scalds or burns.

- When in operation, the door and accessible external surfaces could become very hot.

Always use the knobs, handles and buttons.

Never touch metal parts or the glass.

Use oven gloves if necessary.

- This electrical appliance operates at high temperatures which could cause burns.
 - Do not leave inflammable products near the oven or under the work surface where it is located.
 - Never operate the appliance under a wall cupboard or shelf or near inflammable materials such as curtains, blinds, etc.
 - **If food or other parts of the oven catch fire, never try and put out the flames with water. Close the door, unplug from the mains and smother the flames with a damp cloth.**

Danger!

Failure to observe the warning may result in life threatening injury by electric shock.

- **Before plugging into the mains, make sure that:**
 - **The mains voltage corresponds to the voltage indicated on the rating plate.**
 - **The mains socket has a minimum rating of 16A and an earth wire.**
- **The manufacturer declines all liability in the event that this important accident-prevention rule is not respected.**

- Do not let the power cable dangle and avoid touching hot parts of the oven.
Never unplug the appliance by pulling on the power cable.
- If you intend to use an extension, make sure it is in good condition, that the plug is earthed and that the cross section of the wires is at least equal to that of the power cable provided with the appliance.
- To avoid all risk of electric shock, never immerse the power cable, plug or appliance itself in water.
- **If the power cable is damaged, it must be replaced by the manufacturer, the manufacturer's customer services or a qualified electrician in order to eliminate all risk.**
- For your personal safety, never take the appliance to pieces on your own. Always contact Customer Services.

CE The appliance complies with the following EC directives:

- Low Voltage Directive 2006/95/EC and subsequent amendments;
- EMC Directive 2004/108/EC and subsequent amendments
- Materials and accessories coming into contact with food conform to European regulation (EC) no. 1935/2004.



Disposal

In compliance with European directive 2002/96/EC, the appliance must not be disposed of with household waste, but taken to an authorised waste separation and recycling centre.

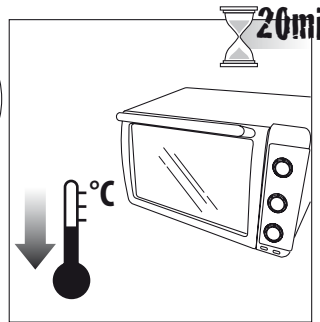
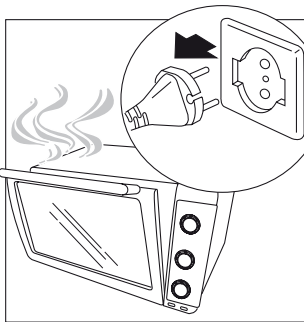
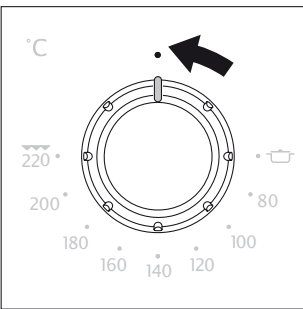
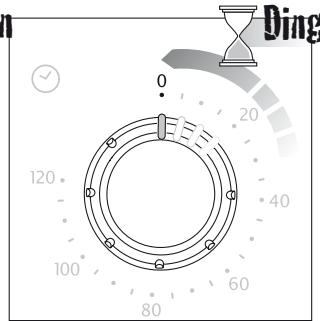
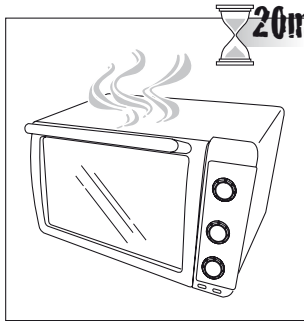
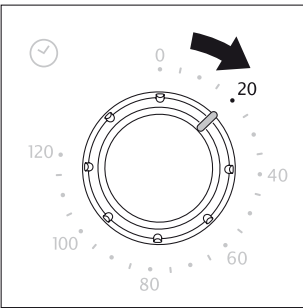
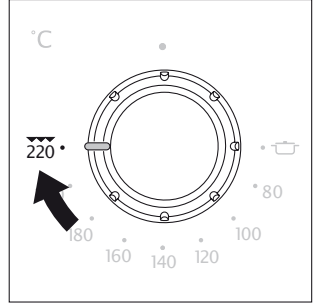
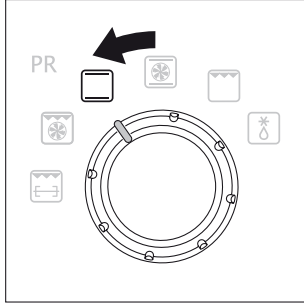
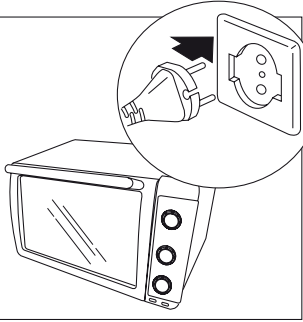
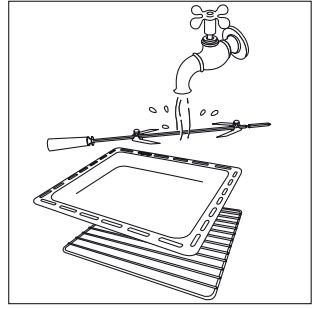
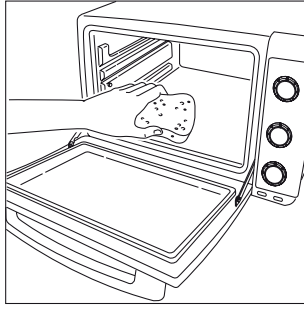
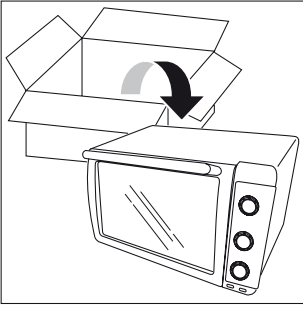
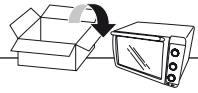

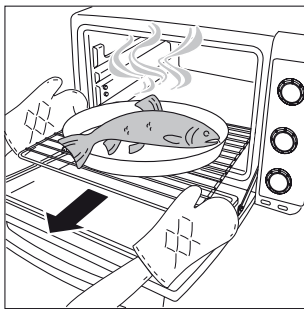
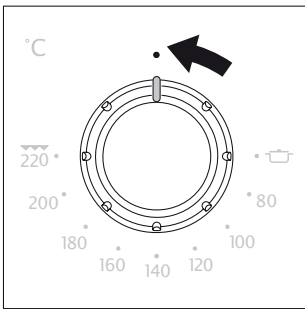
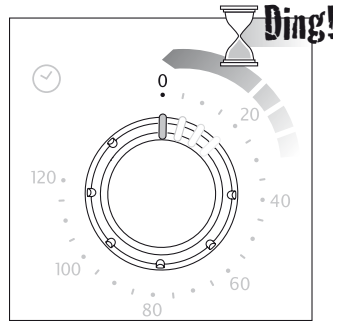
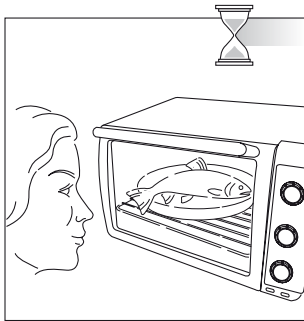
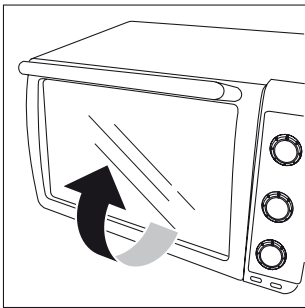
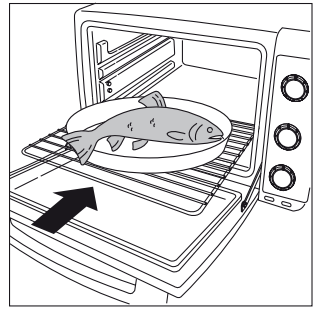
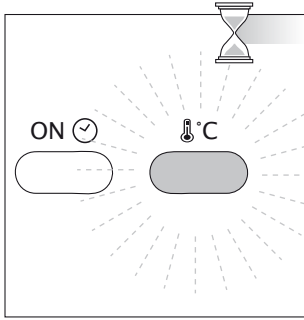
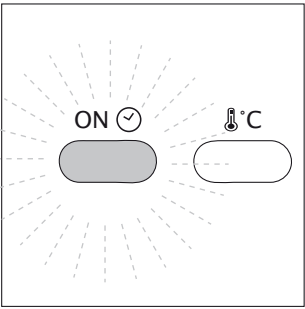
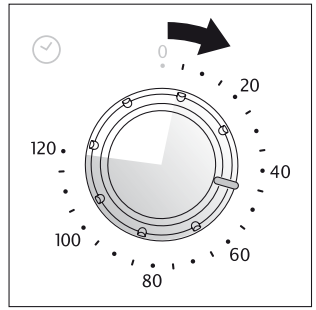
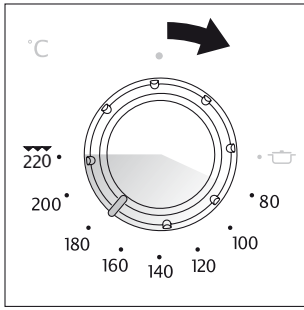
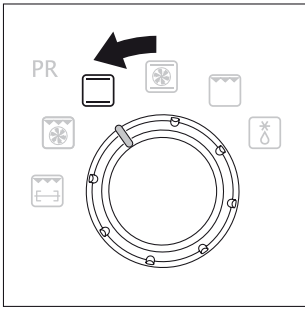

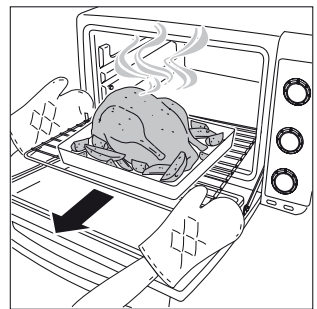
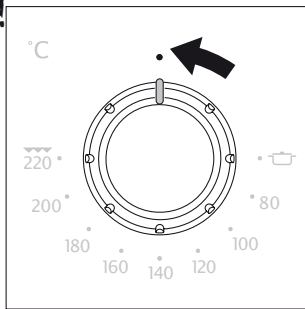
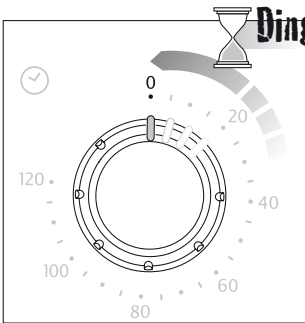
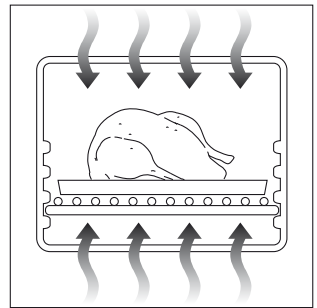
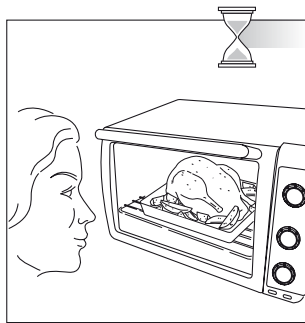
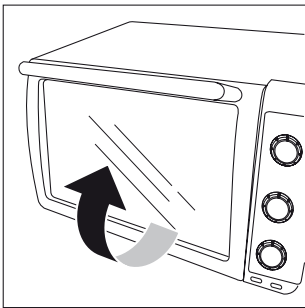
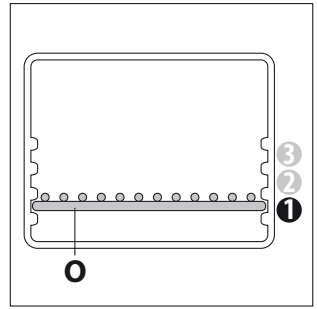
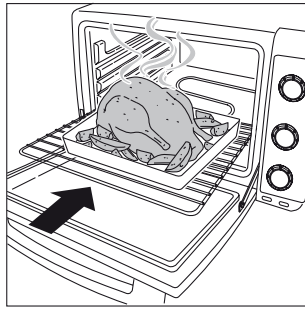
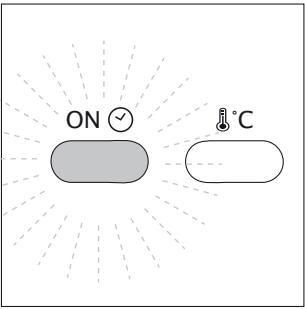
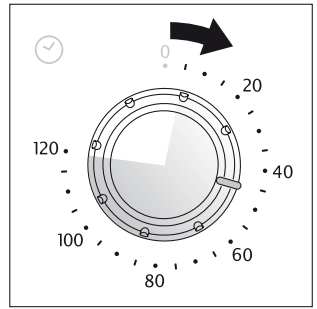
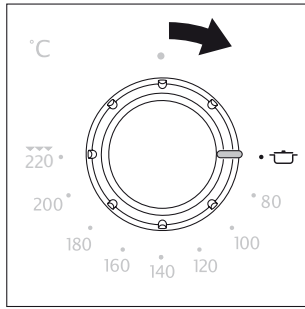
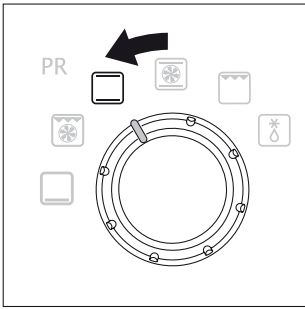

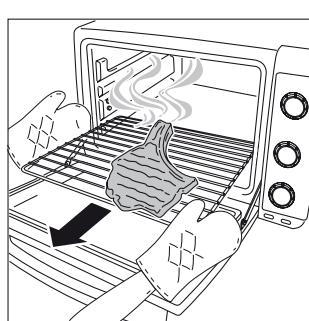
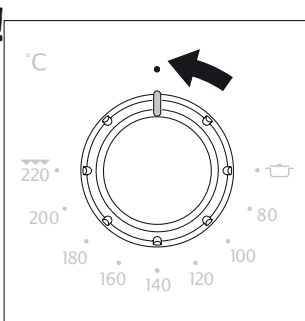
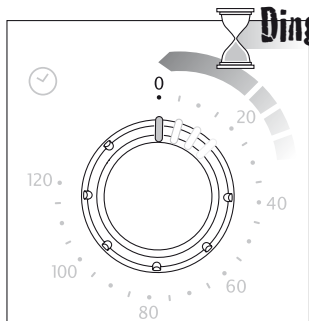
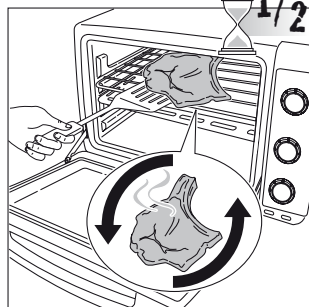
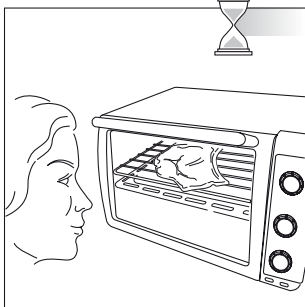
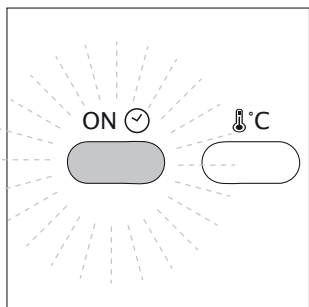
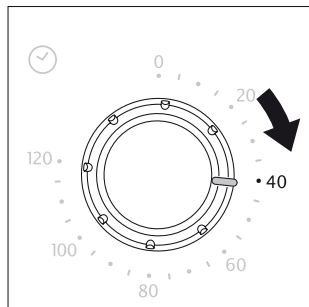
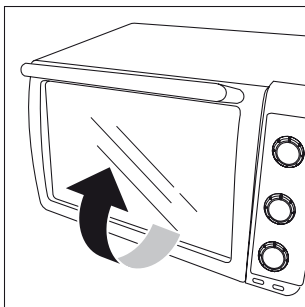
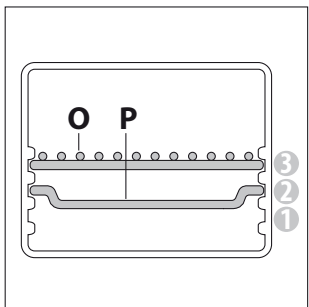
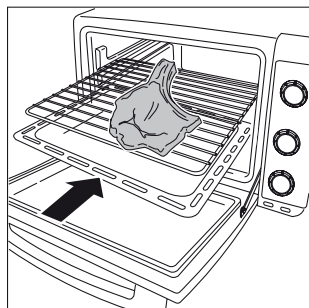
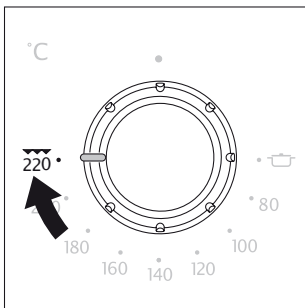
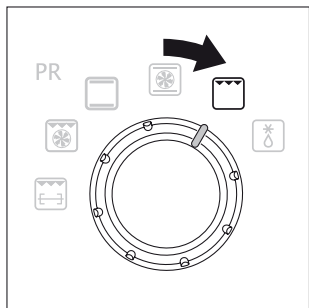

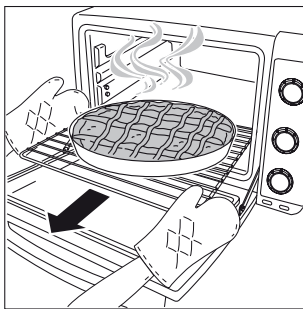
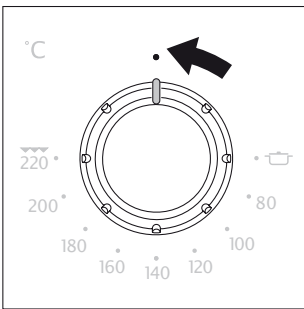
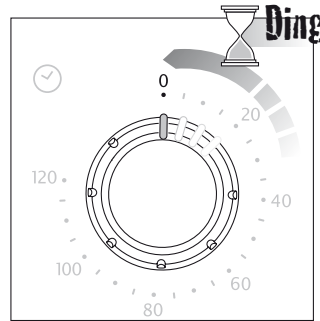
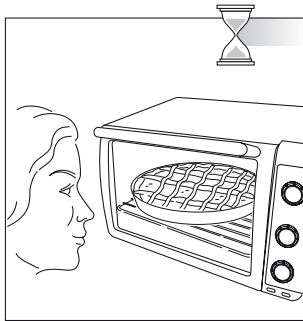
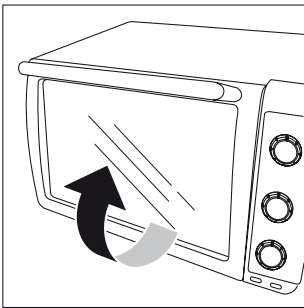
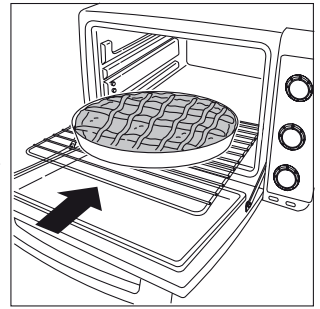
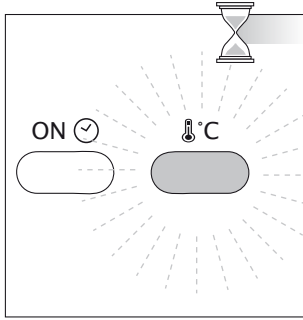
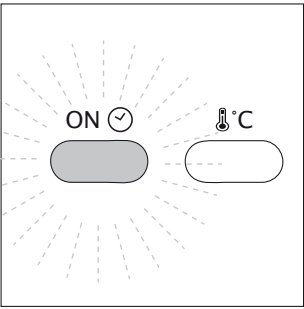
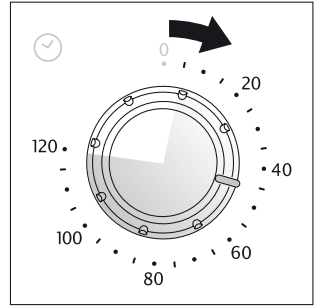
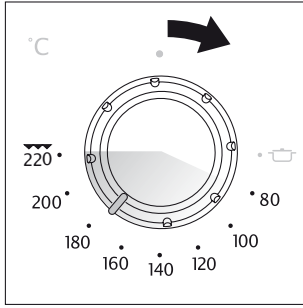
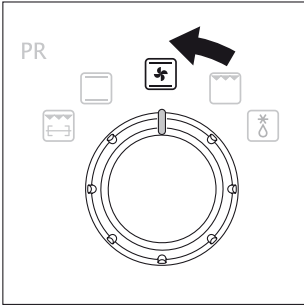

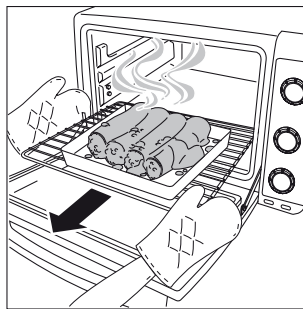
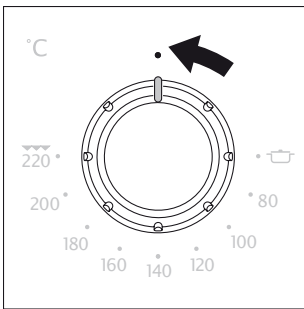
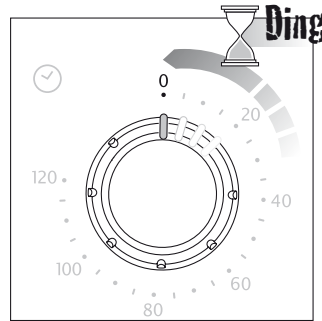
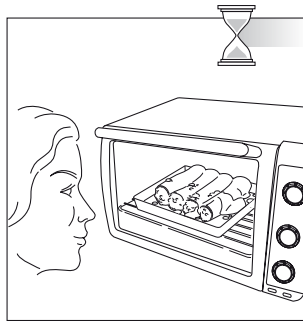
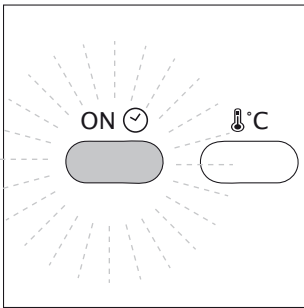
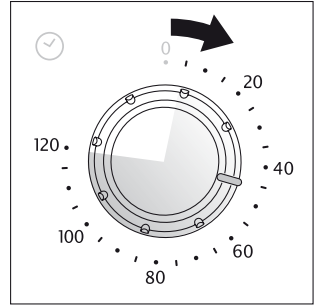
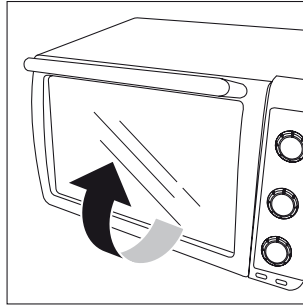
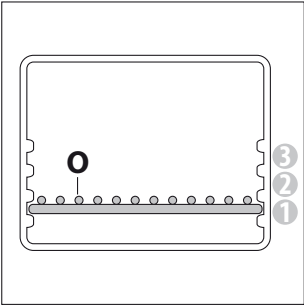
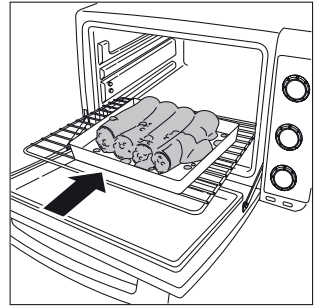
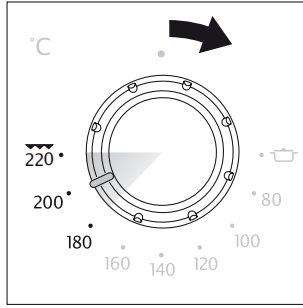
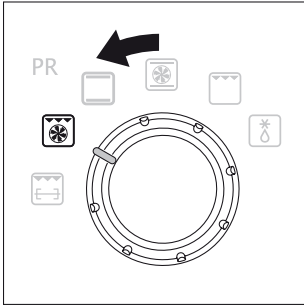

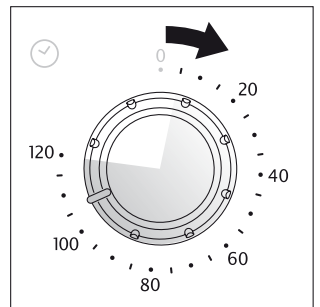
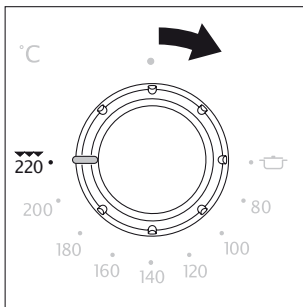
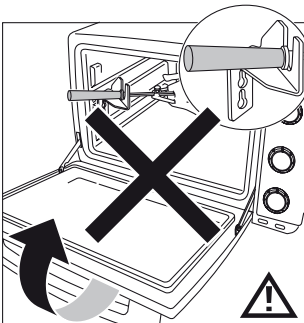
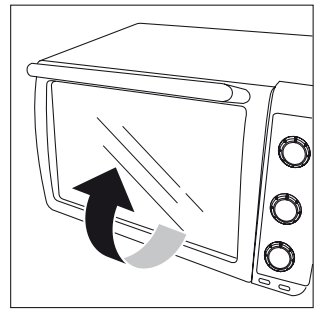
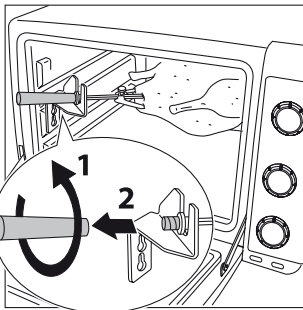
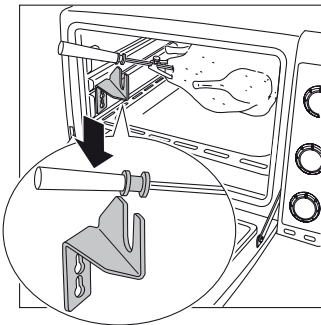
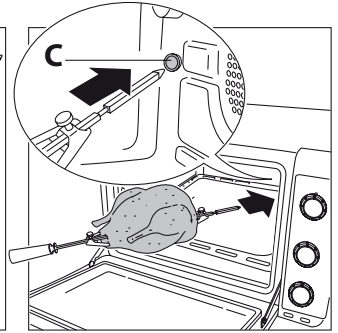
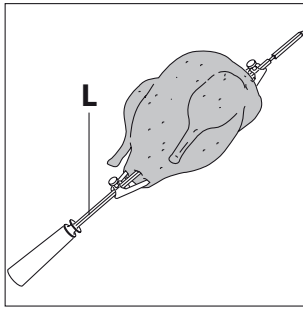
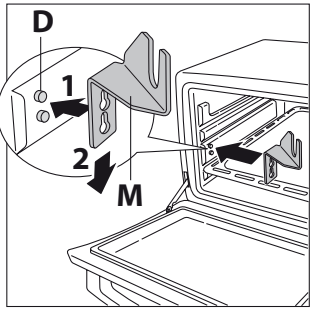
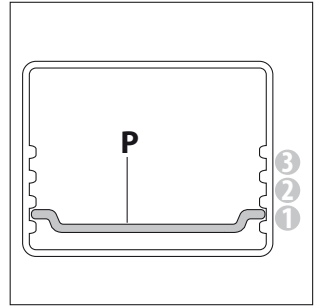
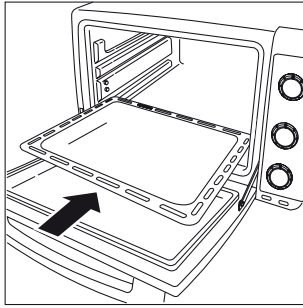
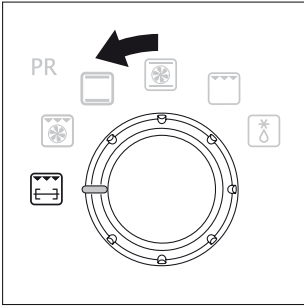





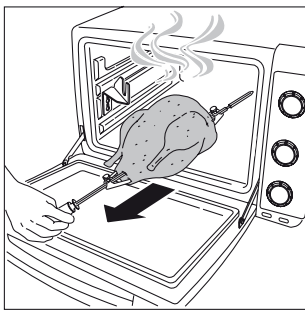
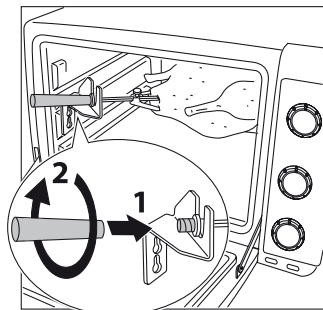
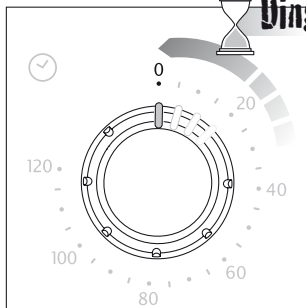
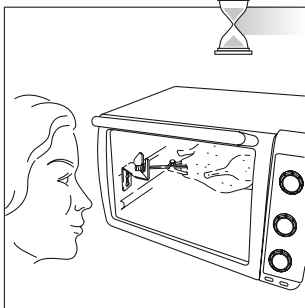
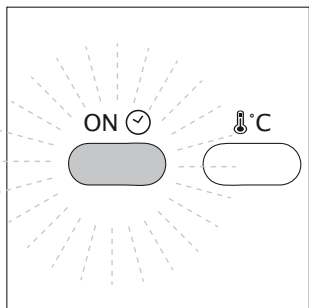

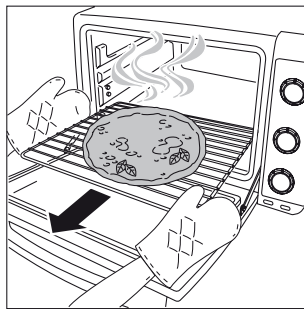
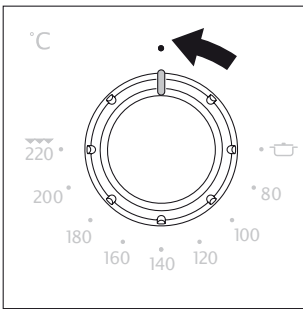
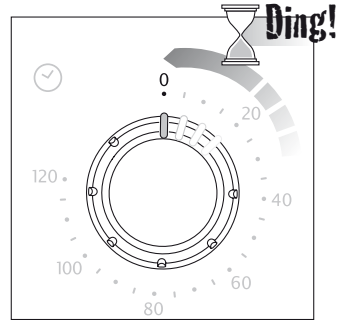
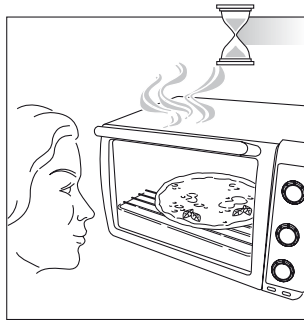
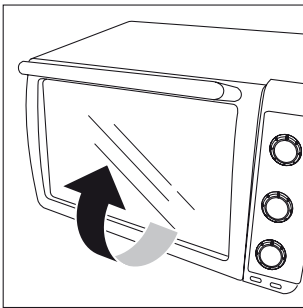
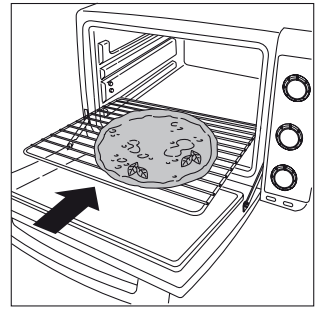
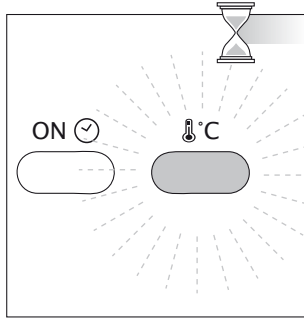
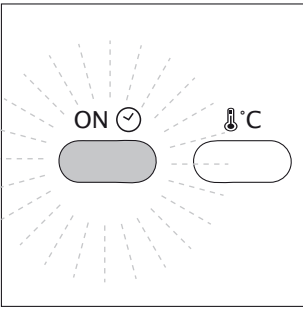
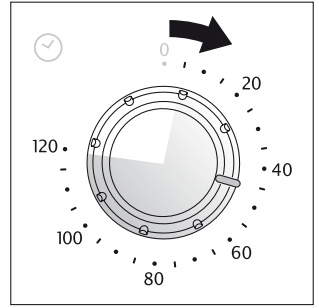
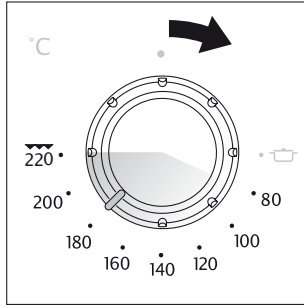
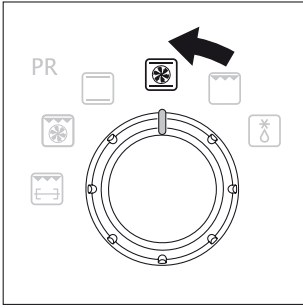

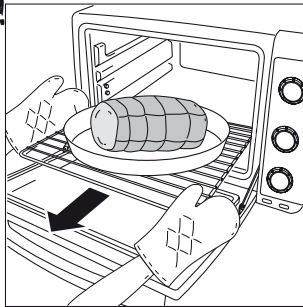
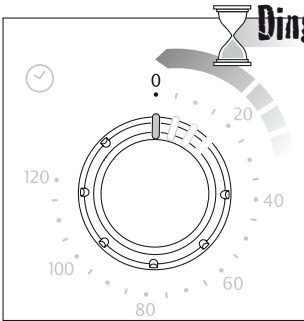
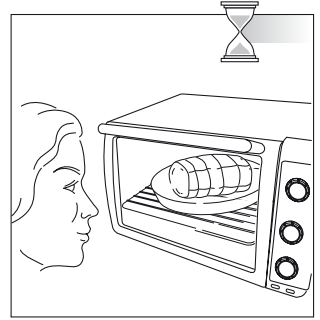
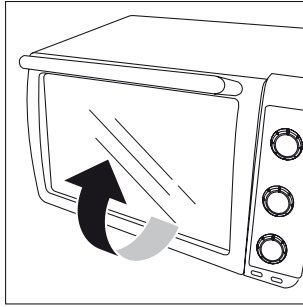
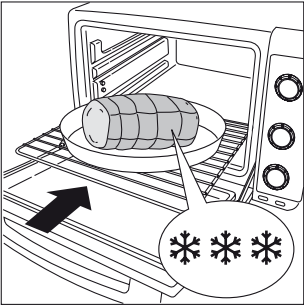
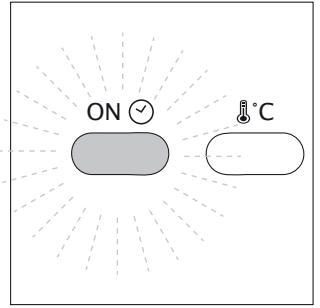
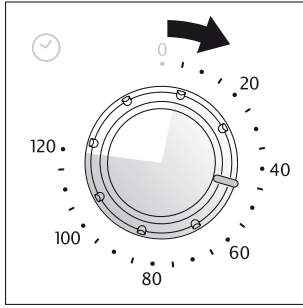
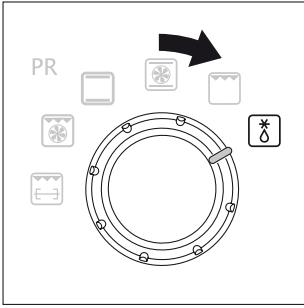

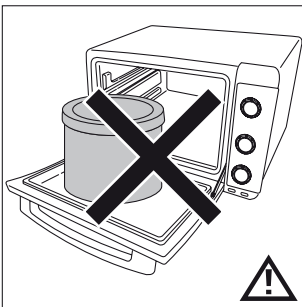
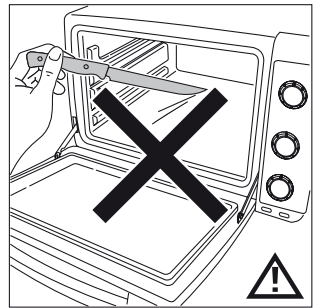
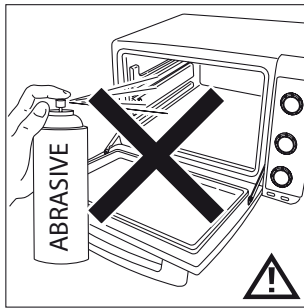
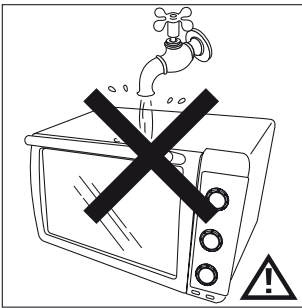
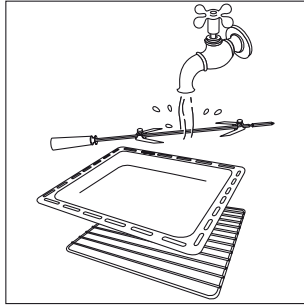
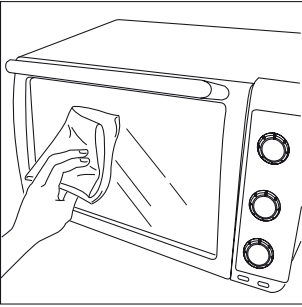
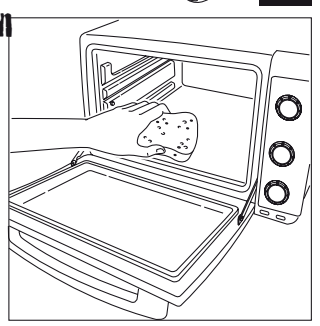
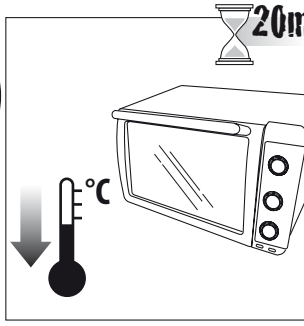
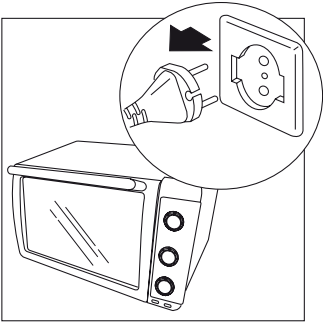



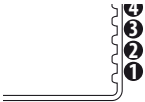
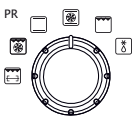







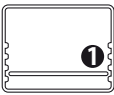

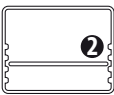









Ding!

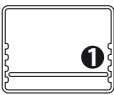











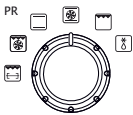













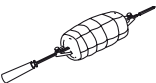













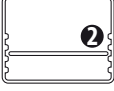









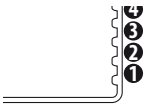
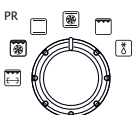















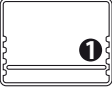









					
	700g			180 °C	45-50 min
					30-35 min
					37-42 min
	750g			200 °C	25-30 min
	450g			200 °C	20-22 min
					15-17 min
					18-20 min
	500g			180 °C	35-40 min
	1500g			180 °C	35-40 min
				200 °C	30-35 min
	1300g			190 °C	100-105 min
					80-85 min
					90-95 min
	700g			190 °C	65-70 min
					50-55 min
					60-65 min

					
	1000g		  	190 °C	90-95 min 75-80 min 85-90 min
	1200g			180 °C	55-60 min
	1100g			220 °C	90-95 min
	1250g			220 °C	100-105 min
	750g			220 °C	25-30 min
	1000g			200 °C	25-30 min
 ***	1000g		  	200 °C	65-70 min 45-50 min 60-65 min
	1000g		  	200 °C	55-60 min 45-50 min 50-55 min
	1000g			220 °C	15-20 min

					
	300g			180 °C	15-20 min
 ***	6			180 °C	20-22 min
					13-15 min
					18-20 min
	850g			180 °C	40-45 min
					30-35 min
					35-40 min
	850g			180 °C	40-45 min
					30-35 min
					35-40 min
	900g			180 °C	35-40 min
					25-30 min
					30-35 min
	12			170 °C	20-25 min
	900g			160 °C	85-90 min