



Register Now 
www.delonghi.com/register

ESAM0411X

COFFEE MAKER

Instructions for use. Keep these instructions

Visit www.delonghi.com for a list of service centers

near you.

ELECTRIC CHARACTERISTICS

120 V~ 60 Hz 1350 W

MACHINE À CAFÉ

Mode d'emploi . Conservez cette notice

Visitez www.delonghi.com pour y voir une liste des

centres de réparation proches de chez vous.

CARACTÉRISTIQUES ÉLECTRIQUES

120 V~ 60 Hz 1350 W



CAFETERA

Repase y guarde estas instrucciones.

Lea cuidadosamente este instructivo antes de usar

su aparato.

Visite www.delonghi.com para ver la lista de

centros de servicios cercanos a usted.

CARACTERISTICAS ELECTRICAS:

120 V~ 60 Hz 1350 W

DeLonghi

EN

page 6

FR

pag. 6

ES

pág. 6

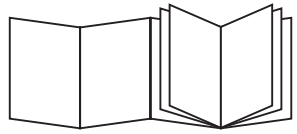

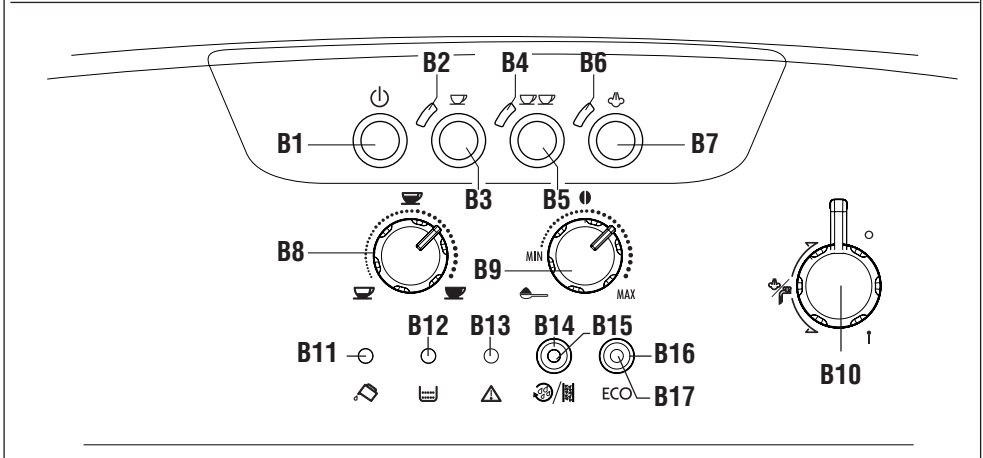
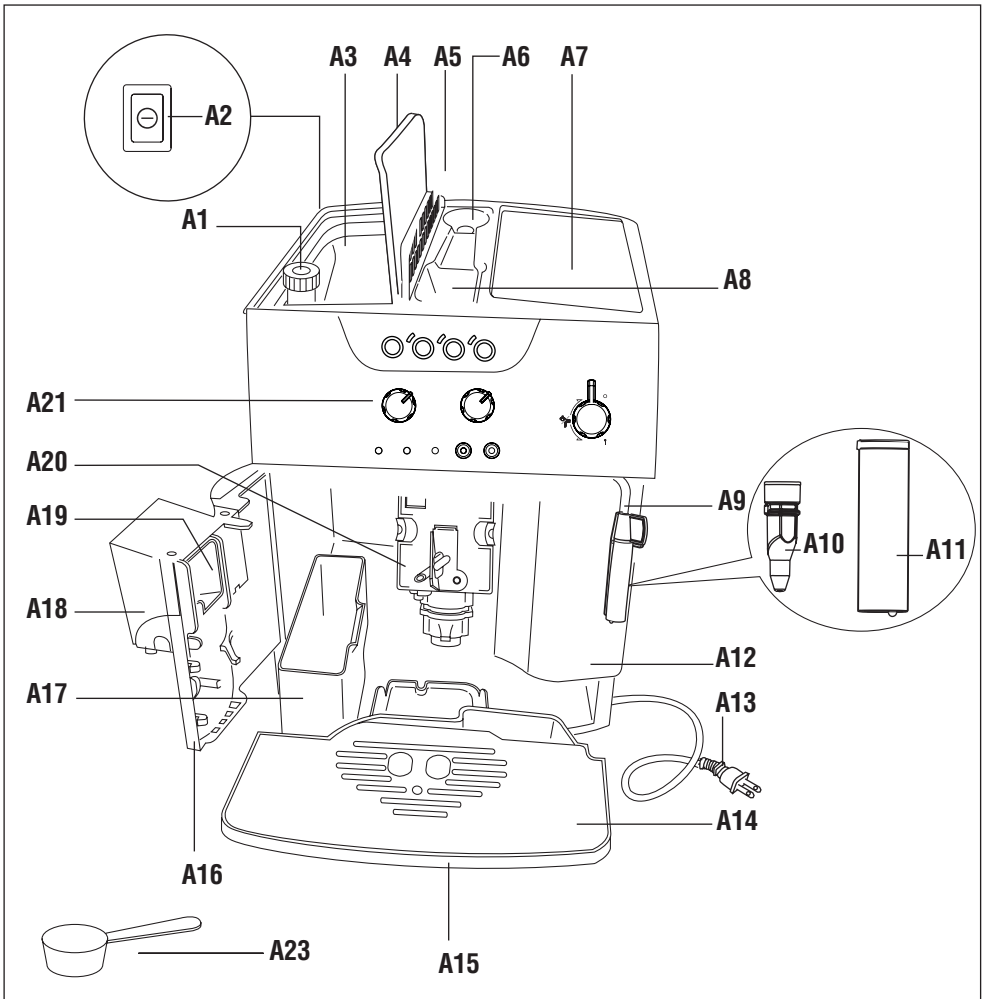

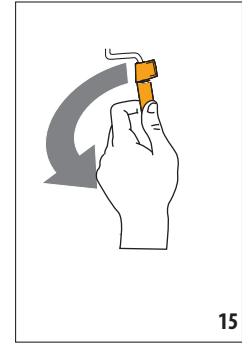
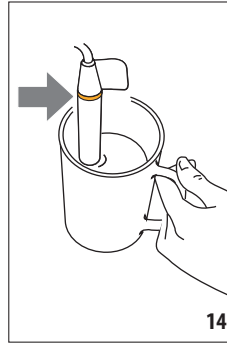
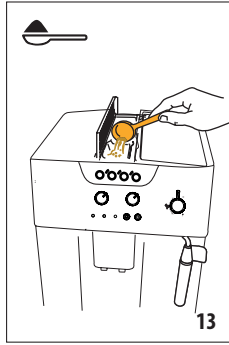
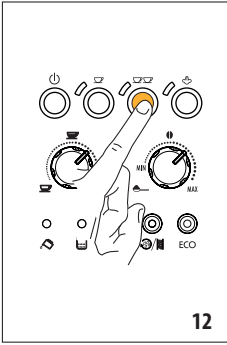
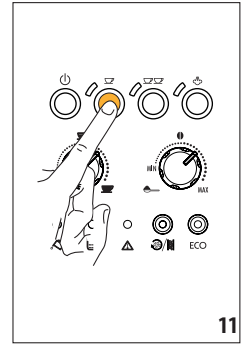
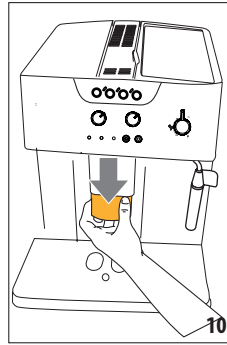
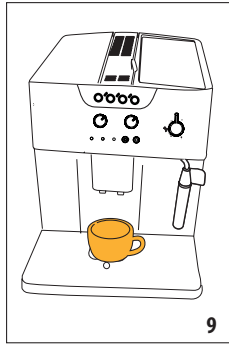
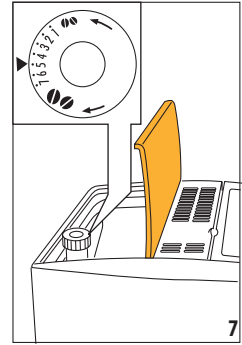
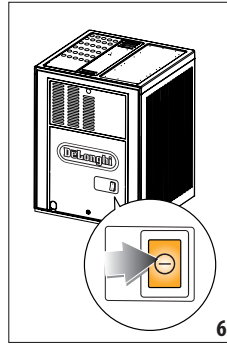
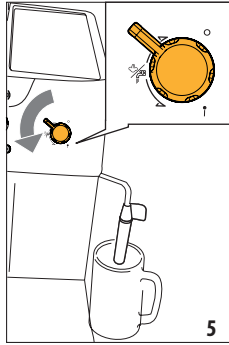
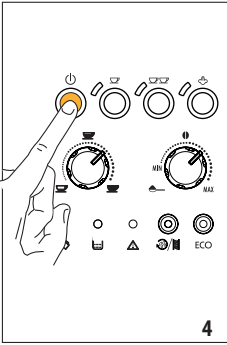
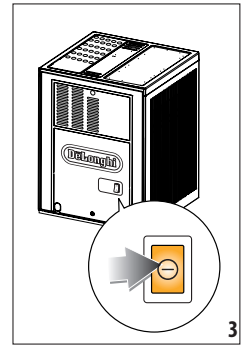
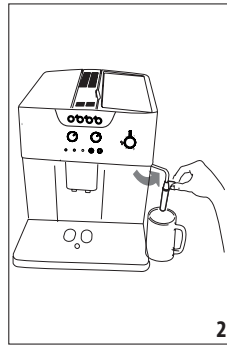
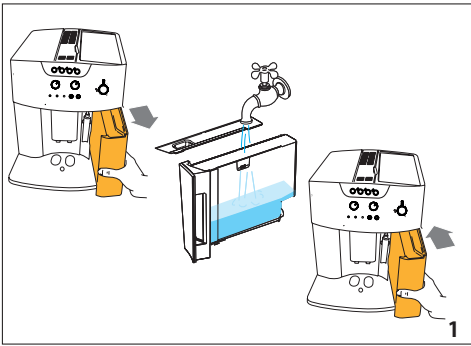

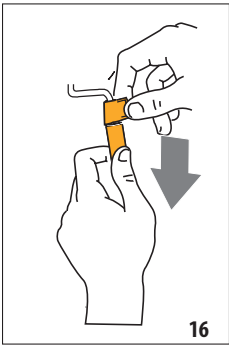

16

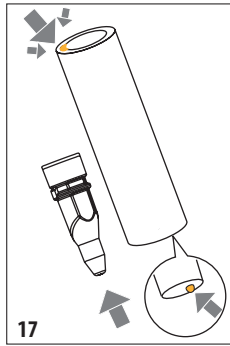

17

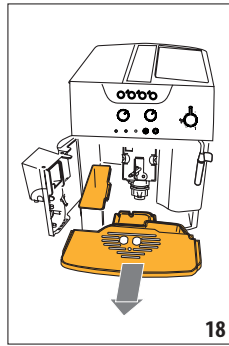

18

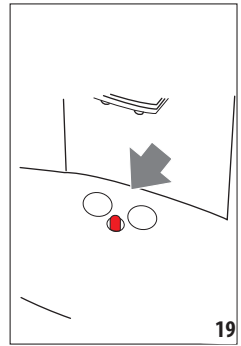

19

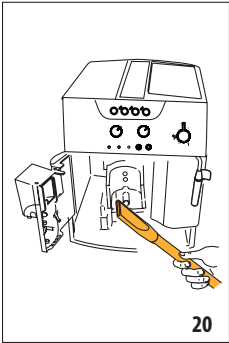

20

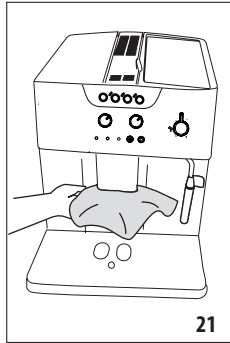

21

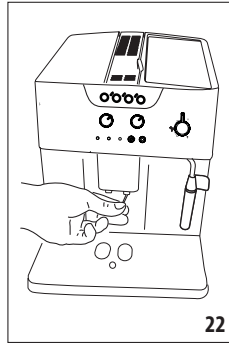

22

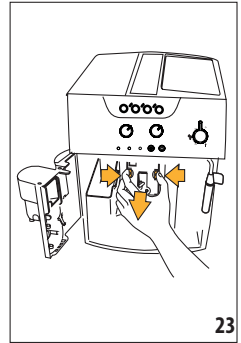

23