



De'Longhi Appliances
via Seitz, 47
31100 Treviso Italia

COFFEE MAKER

Instructions



ESAM 04.110

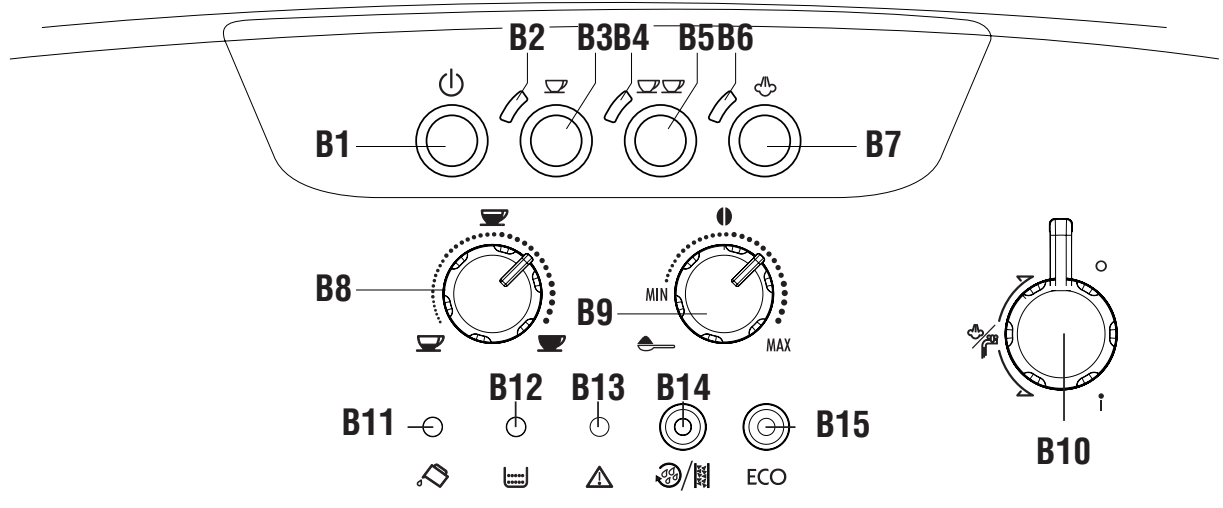
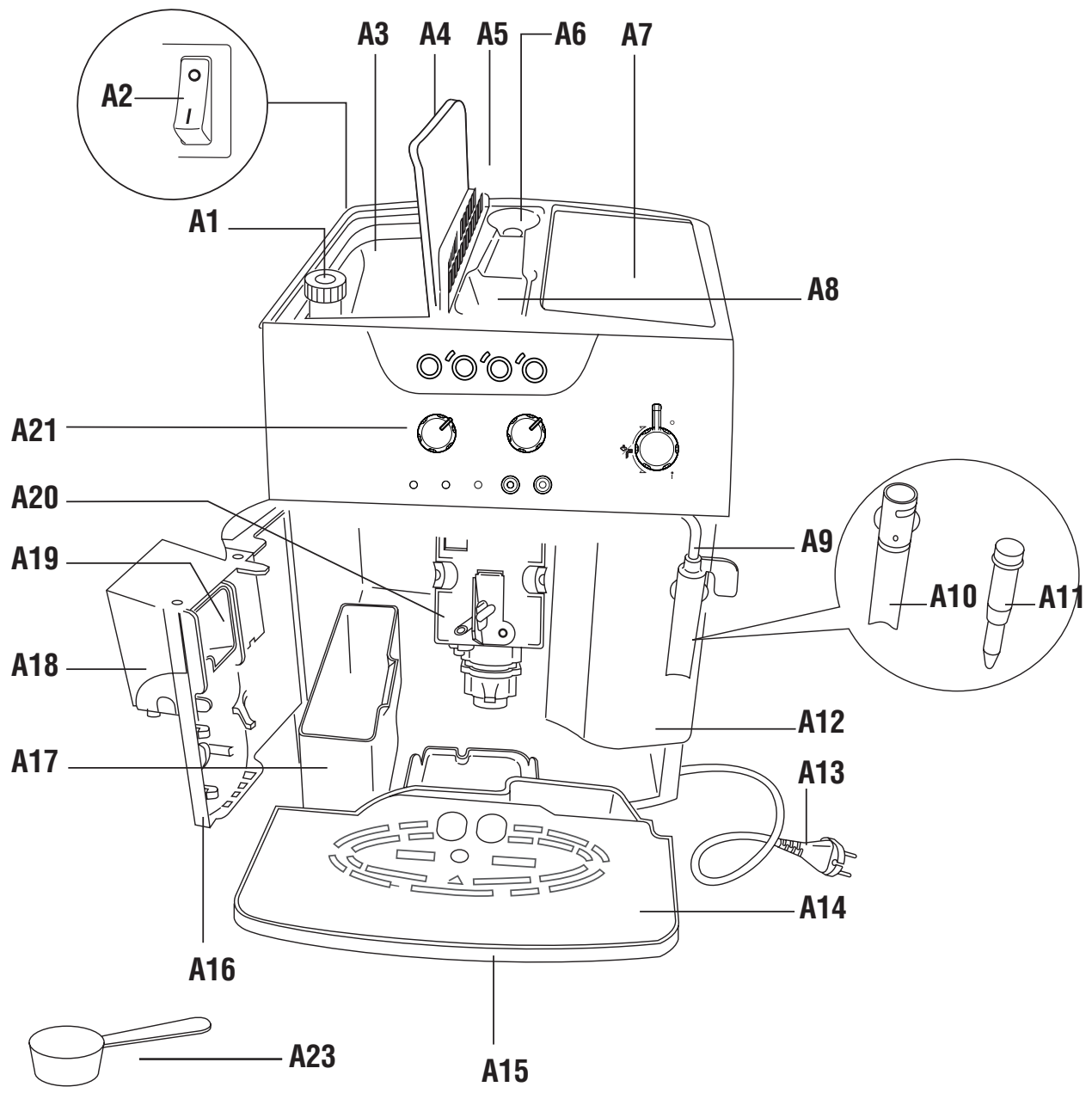

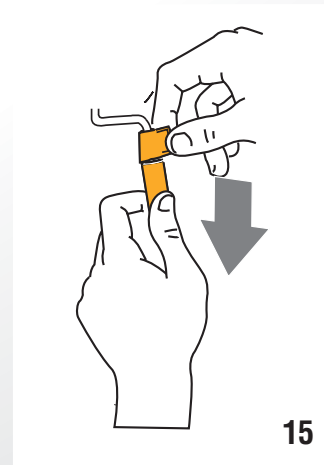
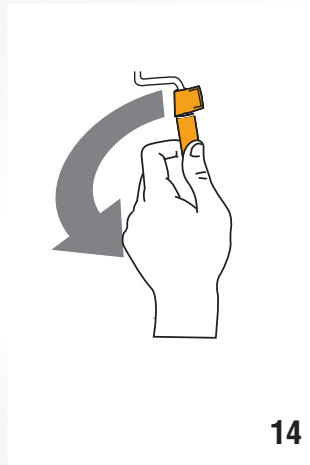
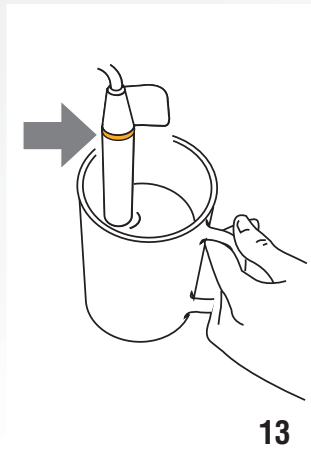
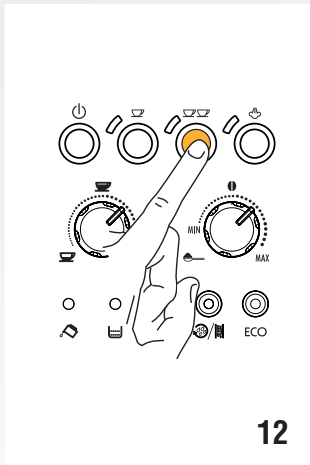
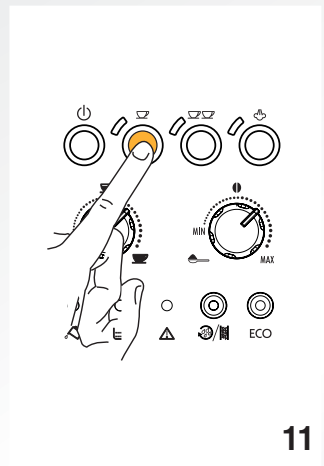
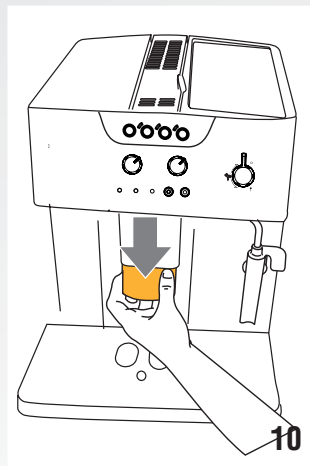
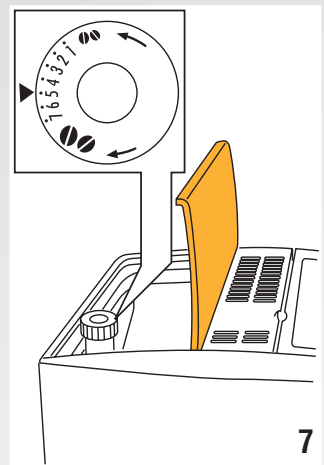
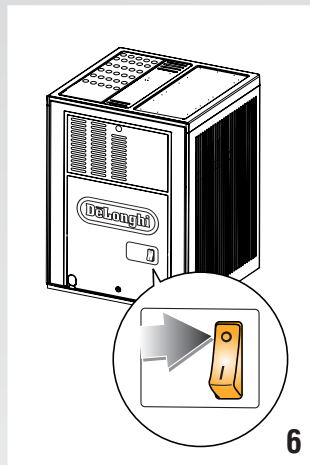
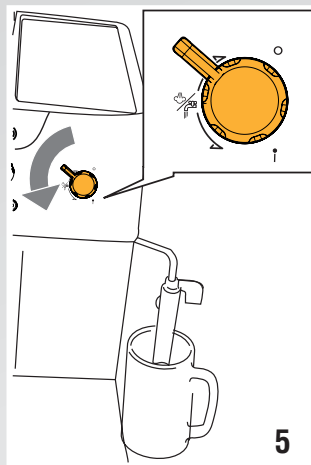
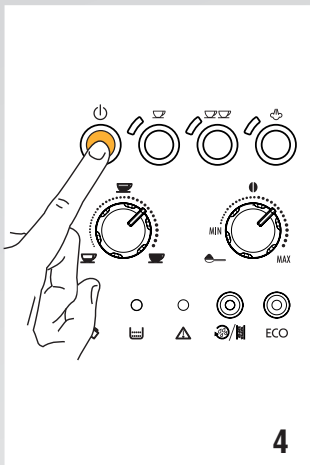
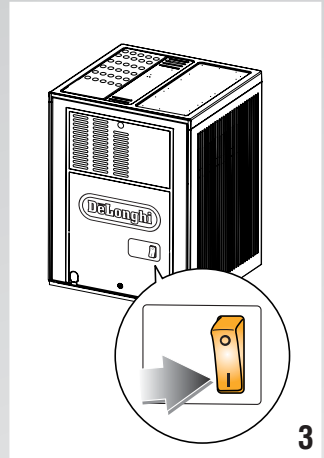
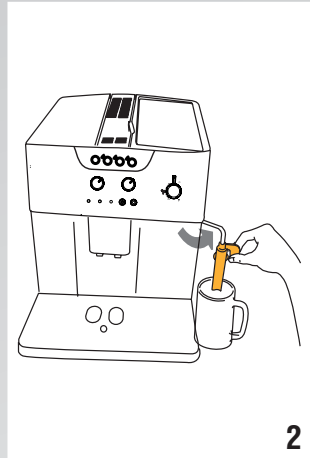
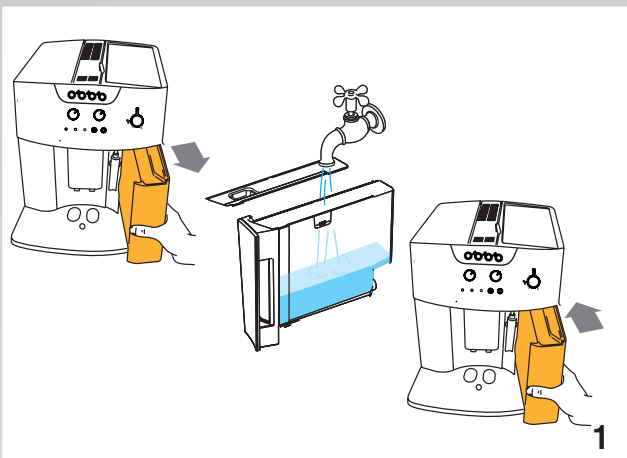

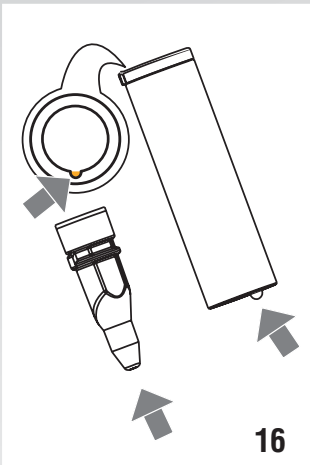

16

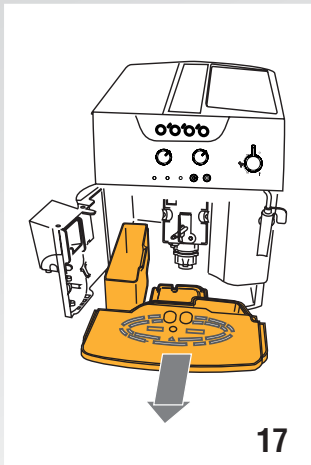

17

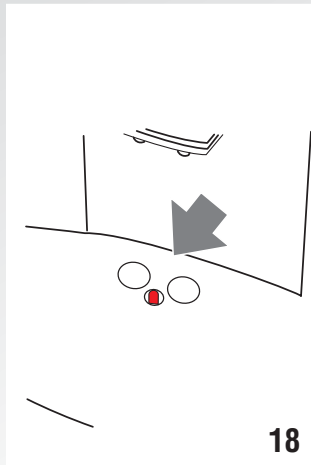

18

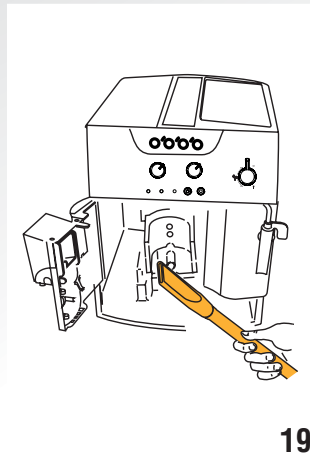

19

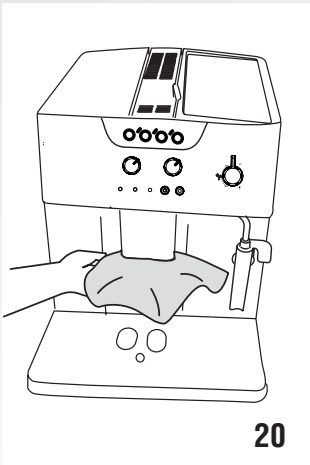

20

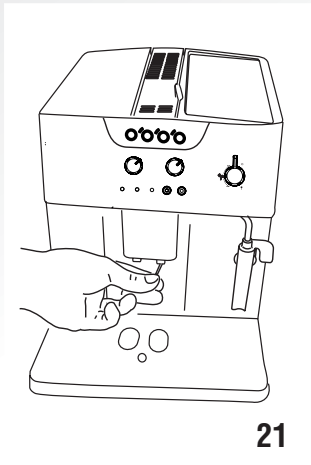

21

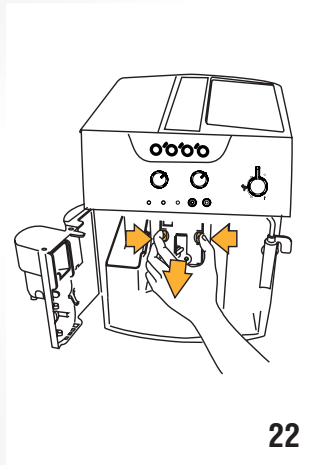

22

CONTENTS

1. IMPORTANT SAFEGUARDS	7
1.1 California Proposition 65	7
1.2 Short cord instructions	8
2. INTRODUCTION.....	8
2.1 Symbols used in these instructions	8
2.2 Letters in brackets	8
2.3 Troubleshooting and repairs.....	8
2.4 Video instruction manual available on:	8
3. DESCRIPTION.....	8
3.1 Description of the appliance.....	8
3.2 Description of control panel	9
4. PRELIMINARY CHECKS.....	9
4.1 Checking the appliance	9
4.2 Installing the appliance.....	9
4.3 Connecting the appliance.....	9
4.4 Using the appliance for the first time	9
5. TURNING THE APPLIANCE ON.....	10
6. TURNING THE APPLIANCE OFF	10
7. SETTING AUTO-OFF (STAND-BY)	10
8. SETTING TEMPERATURE	10
9. ENERGY SAVING.....	10
10. MAKING COFFEE.....	10
10.1 Selecting the coffee taste	10
10.2 Selecting the quantity of coffee in the cup ..	11
10.3 Adjusting the coffee mill	11
10.4 Tips for a hotter coffee.....	11
10.5 Making coffee using coffee beans	11
10.6 Making coffee using pre-ground coffee.....	12
11. MAKING CAPPUCCINO	12
11.1 Cleaning the cappuccino maker after use....	12
12. HEATING WATER	13
13. CLEANING.....	13
13.1 Cleaning the coffee maker.....	13
13.2 Cleaning the coffee grounds container.....	13
13.3 Cleaning the drip tray.....	13
13.4 Cleaning the inside of the machine	13
13.5 Cleaning the water tank	14
13.6 Cleaning the coffee spouts	14
13.7 Cleaning the pre-ground coffee funnel	14
13.8 Cleaning the infuser	14
14. DESCALING.....	14
15. SETTING WATER HARDNESS	15
15.1 Measuring water hardness	15
15.2 Set water hardness.....	15
16. TECHNICAL SPECIFICATION	15
17. MEANING OF LIGHTS DURING NORMAL OPERATION	16
18. MEANING OF THE ALARM LIGHTS	17
19. TROUBLESHOOTING	18

1. IMPORTANT SAFEGUARDS

When using electrical appliances, basic safety precautions should always be followed, including the following.

- Read all instructions carefully.
- Make sure the voltage of your electrical system corresponds to the voltage shown on the bottom of the machine.
- Do not touch hot surfaces. Use handles or knobs.
- To protect against fire, electrical shock and personal injury, do not immerse cord, plug or appliance in water or other liquid.
- Keep the appliance out of the reach of children and do not leave appliance unattended while in operation.
- Unplug from the outlet when not in use and before cleaning.
- Do not operate with a damaged cord or plug, or after the appliance malfunctions, or has been damaged in any manner. Return the appliance to the nearest authorized service facility for examination, repair or adjustment.
- The use of accessory attachments not recommended by the manufacturer may result in fire, electrical shock, or personal injury.
- Do not use outdoors.
- Make sure the power cord does not hang over the edge of the table or counter-top to avoid getting accidentally caught or entangled.
- Do not place the appliance or its electrical parts on or near electric stoves, cooking surfaces, or gas burners.
- Plug cord into the wall outlet. To disconnect, first turn machine "off", then remove plug from wall outlet.
- Do not use the appliance for other than the intended use. This appliance is to be utilized for domestic use only. The manufacturer declines all responsibility for any damage caused by improper, incorrect, or irresponsible use.

WARNING: To reduce the risk of fire or electric shock, do not remove the cover or the exterior of the unit. Don't attempt to repair or modify the machine, doing so will void the warranty. Repair should be done by authorized service personnel only!

1.1 California Proposition 65

This product contains chemicals known to the State of California to cause cancer, birth defects or other reproductive harm.

SAVE THESE INSTRUCTIONS
THIS APPLIANCE IS FOR HOUSEHOLD USE ONLY

1.2 Short cord instructions

- A short power cord is provided to reduce risks resulting from becoming entangled in or tripping over a longer cord.
- Longer, detachable power supply cords or extension cords are available and may be used if care is exercised in their use.
- If an extension cord is used, the marked electrical rating should be at least as great as the electrical rating of the appliance. If the appliance is provided with 3- wire, grounding type cord, the extension should be a GROUNDING TYPE 3 - WIRE CORD. The longer cord should be arranged so that it will not drape over the counter-top or table top where it can be pulled on by children or tripped over.
- Your product is equipped with a polarized alternating current line plug (a plug having one blade wider than the other). This plug will fit into the power outlet only one way. This is a safety feature. If you are unable to insert the plug fully into the outlet, try reversing the plug. If the plug should still fail to fit, contact your electrician to replace your obsolete outlet. Do not defeat the safety purpose of the polarized plug.

2. INTRODUCTION

Thank you for choosing the ESAM04110 automatic coffee maker. We hope you enjoy using your new appliance. Take a few minutes to read these instructions. This will avoid all risks and damage to the machine.

2.1 Symbols used in these instructions

Important warnings are identified by these symbols. It is vitally important to observe these warnings.



Danger!

Failure to observe the warning could result in life threatening injury from electric shock.



Important!

Failure to observe the warning could result in injury or damage to the appliance.



Danger of burns!

Failure to observe the warning could result in scalds.



Please note:

This symbol identifies important advice or information for the user.

2.2 Letters in brackets

The letters in brackets refer to the legend in the Description of the Appliance on page 3.

2.3 Troubleshooting and repairs

In the event of problems, first try and resolve them following the information given in the section "19. TROUBLESHOOTING" and "18. MEANING OF THE ALARM LIGHTS".

If this does not resolve the problem or you require further information, you should consult Customer Experience by calling the number given on the annexed "Customer Experience" sheet. If your country is not among those listed on the sheet, call the number given in the guarantee.

If repairs are required, contact De'Longhi Customer Experience only.

Contact details are given in the guarantee certificate provided with the appliance.

2.4 Video instruction manual available on:

<http://esam04110.delonghi.com>

3. DESCRIPTION

3.1 Description of the appliance









(page 3 - A)

- A1. Grinding adjustment knob
- A2. Main switch (on back of appliance)
- A3. Beans container
- A4. Beans container lid
- A5. Pre-ground coffee funnel lid
- A6. Compartment for measuring spoon
- A7. Cup shelf
- A8. Pre-ground coffee funnel
- A9. Steam spout
- A10. Cappuccino maker (removable)
- A11. Steam nozzle (removable)
- A12. Water tank
- A13. Power cable
- A14. Cup tray

- A15. Drip tray
- A16. Infuser door
- A17. Coffee grounds container
- A18. Coffee spout (adjustable height)
- A19. Coffee guide
- A20. Infuser
- A21. Control panel

3.2 Description of control panel

(page 3 - B)

- B1.  button: turns the appliance on and off (stand-by).
- B2. 1 cup and coffee temperature OK light
- B3.  button: to make 1 cup of coffee
- B4. 2 cups and coffee temperature OK light
- B5.  button: to make 2 cups of coffee
- B6. Steam and steam temperature OK light
- B7.  button: to select the steam function
- B8. Coffee quantity selection knob (short, standard or long)
- B9. Selection knob to choose coffee taste (for a mild, standard or strong coffee) or use pre-ground coffee .
- B10. Steam/hot water knob
- B11.  light: no water or water tank absent
- B12.  light: grounds container full or absent
- B13.  light: general alarm
- B14.  button to select rinsing or descaling
- B15. Descaling light
- B16. **ECO** button to select energy saving mode
- B17. Energy saving mode light

4. PRELIMINARY CHECKS

4.1 Checking the appliance

After removing the packaging, make sure the product is complete and undamaged and that all accessories are present.

Do not use the appliance if it is visibly damaged.

Contact De'Longhi Customer Services.

4.2 Installing the appliance



When you install the appliance, you should respect the following safety warnings:

- The appliance gives off heat. After positioning the appliance on the worktop, leave a space of at least 1.18 in/ 3 cm between the surfaces of the appliance and the side and rear walls and at least 6 in/ 15 cm above the coffee maker.
- Water penetrating the appliance could cause damage. Do not place the appliance near taps or sinks.
- The appliance could be damaged if the water it contains freezes. Do not install the appliance in a room where the temperature could drop below freezing point.

- Arrange the power cable in such a way that it cannot be damaged by sharp edges or contact with hot surfaces (e.g. electric hot plates).

4.3 Connecting the appliance



Check that the mains power supply voltage corresponds to the value indicated on the rating plate on the bottom of the appliance.







Connect the appliance to an efficiently earthed and correctly installed socket with a minimum current rating of 10A only.

If the power socket does not match the plug on the appliance, have the socket replaced with a suitable type by a qualified professional.

4.4 Using the appliance for the first time



- Coffee has been used to factory test the appliance and it is therefore completely normal for there to be traces of coffee in the mill.
The machine is, however, guaranteed to be new.
- You should customise water hardness as soon as possible following the instructions in the section "15. SETTING WATER HARDNESS".

1. Remove the water tank (A12), fill to the MAX line with fresh water then replace in the appliance (fig. 1).
2. Turn the cappuccino maker (A9) outwards and place a container with a minimum capacity of 3.38 fl.oz. / 100 ml underneath (fig. 2).
3. Plug the appliance into the mains socket and place the main switch (A2) on the back of the appliance in the **I** position (fig. 3).
4. The  (B2),  (B4),  (B6) lights flash simultaneously.
5. Turn the steam/hot water knob (B10) a half turn counterclockwise as far as it will go to position **I** (fig. 5). Water is delivered from the cappuccino maker (it is normal for the appliance to make some noise).
6. Wait for delivery of hot water to stop automatically. The , ,  lights flash to indicate that you must close the steam tap by turning the steam/hot water knob to the 0 position.
7. Turn the steam/hot water knob to the **0** position. The appliance goes off automatically.

To use the appliance, turn it on.

i Please note :

- When using the appliance for the first time, you need to make 4-5 cups of coffee or 4-5 cappuccinos before the appliance starts to give satisfactory results.

5. TURNING THE APPLIANCE ON

i Please note :



Before turning the appliance on, make sure the main switch (A2-fig. 3) on the back of the appliance is in the **I** position.

Each time the appliance is turned on, it performs an automatic preheat and rinse cycle which cannot be interrupted.

The appliance is ready for use only after completion of this cycle.

⚠ Danger of burns!

During rinsing, a little hot water comes out of the coffee spouts (A18) and is collected in the drip tray underneath (A15). Avoid contact with splashes of water.

- To turn the appliance on, press the  button (B1-fig. 4). The  (B2) and  (B4) lights flash while the appliance is heating up and performing an automatic rinse cycle. By circulating the hot water, the appliance heats the boiler and the internal circuits. During this phase, the light flashes.

When the  and  lights remain on steadily, the appliance is at temperature.

6. TURNING THE APPLIANCE OFF

Each time the appliance is turned off, it performs an automatic rinse cycle which cannot be interrupted.

⚠ Danger of burns!

During rinsing, a little hot water flows from the coffee spouts. Avoid contact with splashes of water.

To turn the appliance off, press the  button (B1-fig. 4). The appliance performs a rinse cycle then goes off.

i Please note :

If the appliance is not used for an extended period, place the main switch in the **0** position (A2-fig. 6).

⚠ Important!

To avoid damaging the appliance, never place the main switch (fig. 6) in the **0** position while the appliance is on.

7. SETTING AUTO-OFF (STAND-BY)

The appliance is set by default to go off if not used for one hours. The time can be changed so that the appliance switches off after 15 or 30 minutes, or after 1, 2 or 3 hours.

1. With the appliance off but the main switch in the **I** position (A2-fig. 3), press and hold the **ECO** button (B16) until

the lights at the bottom of the control panel come on (see image after point 2).

2. Select the required period of time (15 or 30 minutes or 1, 2 or 3 hours) by pressing the  (B7) button (see the light/time table below).

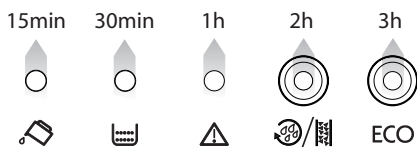



3. Press the **ECO** button to confirm the selection. Auto-off is programmed.

i Please note:

To disconnect the appliance completely, place the main switch at the back of the appliance in the **0** position (fig. 6).

8. SETTING TEMPERATURE

If you want to modify the temperature of the water used to make the coffee (low, medium, high, maximum), proceed as follows:

1. With the appliance off (standby), but the main switch on pos. **I** (A2-fig. 3), press and hold the  button (B3-fig. 11) until the lights on the control panel come on;
2. Press the  button (B5-fig. 12) to select the required temperature:



3. Press the  button to confirm; the lights go off.

9. ENERGY SAVING

Use this function to activate or deactivate energy saving mode. This reduces energy consumption in compliance with current European regulations.

To activate the function, press the **ECO** button (B16), the light (B17) comes on. To deactivate the function, press the **ECO** button. The light goes off.

i Please note:

A few seconds may elapse between energy saving mode and delivery of the first coffee as the appliance must heat up again.

10. MAKING COFFEE

10.1 Selecting the coffee taste

Turn the coffee taste selection knob (B9) to select the required taste. Turning it clockwise increases the quantity of coffee beans the appliance will grind and therefore the strength of the coffee obtained.

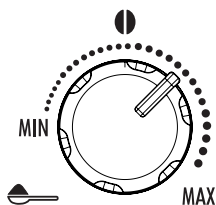

i Please note :

- The first time you use the appliance, you will need to make a number of coffees to identify the correct knob position through trial and error.
- Make sure not to turn the knob too far clockwise, otherwise the coffee may be delivered too slowly (a drop at a time), particularly when making two cups of coffee.

10.2 Selecting the quantity of coffee in the cup

Adjust the coffee quantity selection knob (B8) to set the required quantity.



Turning it clockwise increases the amount of coffee obtained.

i Please note :

The first time you use the appliance, you will need to make a number of coffees to identify the correct knob position through trial and error.

10.3 Adjusting the coffee mill

The coffee mill is set by default to prepare coffee correctly and should not require regulating initially.

However, if after making the first few coffees you find that the coffee is either too weak and not creamy enough or delivery is too slow (a drop at a time), this can be corrected by adjusting the grinding adjustment knob (A1) (fig. 7).

i Please note :

The grinding adjustment knob must only be turned when the coffee mill is in operation.

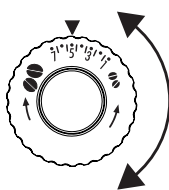

To obtain delivery not a drop at a time, turn one click clockwise towards "7". For fuller bodied creamier coffee, turn one click anticlockwise towards "1" (do not turn more than one click at a time otherwise the coffee could be delivered a drop at a time).

These adjustments will only be evident after at least 2 cups of coffee have been made.

If this adjustment does not obtain the desired result, turn the knob another click.

10.4 Tips for a hotter coffee:

For hotter coffee, you should:

- before delivering the coffee, perform a rinse cycle by pressing the ☉/☉ button (B14). Hot water is delivered from the coffee spout (A18), heating the internal circuits of the appliance and thus raising the coffee temperature.
- warm the cups by rinsing them with hot water (using the hot water function).

10.5 Making coffee using coffee beans

! Important!

Do not use caramelised or candied coffee beans as they could stick to the coffee mill and make it unusable.

1. Fill the container with coffee beans (A3-fig. 8).
2. Place under the coffee spouts (A18):
 - 1 cup, if you want 1 coffee (fig. 9);
 - 2 cups, if you want 2 coffees.
3. Lower the spouts as near as possible to the cup. This makes a creamier coffee (fig. 10).
4. Press the button corresponding to the number of coffees required (1 cup ☉ B3-fig. 11 or 2 cups ☉☉ B5-fig. 12).
5. Preparation begins and the ☉ (B2) or ☉☉ (B4) light stays on until delivery is complete.

i Please note:

- While the machine is making coffee, delivery can be interrupted at any moment by pressing one of the two coffee buttons (☉ or ☉☉).
- At the end of delivery, to increase the quantity of coffee in the cup, just press (within 3 seconds) one of the coffee buttons (☉ or ☉☉).

Once the coffee has been made, the appliance is ready to use again.

**Please note:**

For hotter coffee, see the section "10.4 Tips for a hotter coffee:".

**Important!**

- If the coffee is delivered a drop at a time, too weak and not creamy enough or too cold, read the tips in the "19. TROUBLESHOOTING" section.
- Lights may be displayed on the control panel during use. Their meaning is given in the sections "17. MEANING OF LIGHTS DURING NORMAL OPERATION" and "18. MEANING OF THE ALARM LIGHTS".

10.6 Making coffee using pre-ground coffee**Important!**

- Never add pre-ground coffee when the machine is off or it could spread through the inside of the machine and dirty it. This could damage the appliance.
- Never use more than one level measure or it could dirty the inside of the machine or block the funnel.

**Please note:**

If you use pre-ground coffee, you can only make one cup of coffee at a time.

1. Turn the coffee taste selection knob (B9) anticlockwise as far as it will go to the ☞ position.
2. Make sure the funnel (A8) is not blocked, then add one level measure of pre-ground coffee (A23) (fig. 13).
3. Place a cup under the coffee spouts (fig 9).
4. Press the ☞ cup coffee button (fig. 11).
5. Preparation begins and can be interrupted at any moment by pressing one of the two coffee buttons (☞-B3 or ☞-B5).

To deactivate the pre-ground coffee function, turn the knob to one of the other positions.

**Please note:**

A few seconds may elapse between energy saving mode and delivery of the first coffee.

11. MAKING CAPPUCCINO**Important! Danger of burns!**

During preparation, steam is given off. Take care to avoid scalds.

1. When preparing cappuccino, make the coffee in a large cup;
2. Fill a container with about 3,53 fl.oz/ 100 grams of milk for each cappuccino to be made.

In choosing the size of the container, bear in mind that the milk doubles or triples in volume;

**Please note:**

For a richer denser froth, use skimmed or partially skimmed milk at refrigerator temperature (about 41°F/ 5°C). To avoid milk with poor froth or large bubbles, always clean the cappuccino maker (A9) as described in the section "11.1 Cleaning the cappuccino maker after use".

3. Press the ☞ button (B7). The corresponding light (B6) flashes, indicating that the appliance is heating up;
5. Turn the cappuccino maker outwards and immerse in the milk container (A9- fig. 14);
6. When the ☞ light stops flashing and comes on steadily, turn the steam/hot water knob to the I position (B10 - fig. 5). Steam is delivered from the cappuccino maker, giving the milk a creamy frothy appearance and making it more voluminous;
7. For a creamier froth, rotate the container with slow movements in an upward direction. (You should not discharge steam for more than 3 minutes at a time);
8. When you have obtained the required froth, stop steam delivery by turning the steam/hot water knob back to the 0 position.

**Important! Danger of burns!**

Always turn the steam/hot water knob to the 0 position before removing the container with the frothed milk to avoid burns caused by splashes of boiling milk.

9. Add the milk froth to the cup of coffee prepared previously. The cappuccino is ready. Sweeten to taste and, if desired, sprinkle the froth with a little cocoa powder.

**Please note:**

- If immediately after making cappuccino and deactivating the steam function by pressing the steam button ☞ you press the ☞ (B3) or ☞☞ (B5) button because you want to make another coffee, the coffee maker will be too hot (the ☞ and ☞☞ lights (B2 and B4) flash to indicate an unsuitable temperature). You must wait about ten minutes for the appliance too cool down sufficiently. To cool it down more quickly, after deactivating the steam function, open the steam/hot water knob and let the water flow out of the cappuccino maker into a container until the lights ☞ and ☞☞ stop flashing.

**Danger of burns!**

Avoid contact with splashes of water.

11.1 Cleaning the cappuccino maker after use

Clean the cappuccino maker (A9) each time you use it to avoid the build-up of milk residues or blockages.



Important! Danger of burns!

When cleaning the cappuccino maker, a little hot water is delivered.

Avoid contact with splashes of water.

1. Deliver a little water for a few seconds by rotating the knob to the I position (B10).
Then turn the steam/hot water knob to the 0 position to stop the flow of hot water.
2. Wait for a few minutes for the cappuccino maker (A11) to cool down. Grip the handle of the cappuccino maker tube firmly in one hand and with the other rotate the cappuccino maker anticlockwise (fig. 15) and remove by pulling downwards (fig. 16).
3. Wash all parts of the cappuccino maker thoroughly with a sponge and warm water.
4. Make sure the holes shown by the arrows in fig. 17 are not blocked. If necessary, clean with a pin.
5. Wash all parts of the cappuccino maker thoroughly with a sponge and warm water.
6. Reinsert the nozzle (A10) and replace the cappuccino maker tube (A11) on the nozzle, turning it and pushing it upwards until it is attached.



12. HEATING WATER



Important! Danger of burns!

Never leave the machine unsupervised while delivering hot water.

As shown below, stop delivery of hot water when the cup is full. The cappuccino maker (A9) becomes hot while water is being delivered and must be held by the handle only.

1. Place a container under the cappuccino maker (as close as possible to avoid splashes).
2. Check that the  (B2) and   (B4) lights are on steadily.
3. Turn the steam/hot water knob (B10) a half turn anticlockwise as far as it will go. Delivery begins.
4. Stop by turning the steam/hot water knob to the 0 position.



Please note:

- If "Energy Saving" mode is active, you may have to wait a few seconds before the hot water is delivered.
- To produce steam immediately after preparing hot water, you should open the steam/hot water knob for a few seconds to empty the water circuits.

13. CLEANING

13.1 Cleaning the coffee maker

The following parts of the machine must be cleaned regularly:

- the appliance's internal circuit;
- coffee grounds container (A17),
- drip tray (A15),
- water tank (A12),
- coffee spouts (A18),
- cappuccino maker (A9 - see "11.1 Cleaning the cappuccino maker after use")
- pre-ground coffee funnel (A8),
- inside of the machine, accessible after opening the infuser door (A16),
- infuser (A20).



Important!

- Do not use solvents, abrasive detergents or alcohol to clean the coffee maker.

With De'Longhi superautomatic coffee makers, you need not use chemical products to clean the machine. The descaler recommended by De'Longhi is made from natural and completely biodegradable substances.

- None of the components can be washed in a dishwasher.
- Do not use metal objects to remove encrustations or coffee deposits as they could scratch metal or plastic surfaces.

13.2 Cleaning the coffee grounds container

When the  light flashes (B12), the coffee grounds container needs emptying (A17). Unless you clean the grounds container, the light will continue to flash and the appliance cannot be used to make coffee. To clean (with the machine on):

- Open the service door (A16) on the front of the appliance, extract the drip tray (A15-fig. 18), empty and clean.
- Empty the grounds container and clean thoroughly to remove all residues left on the bottom.



Important!

When removing the drip tray, the grounds container **must** be emptied, even if it contains few grounds.

If this is not done, when you make the next coffees, the grounds container may fill up more than expected and clog the machine.

13.3 Cleaning the drip tray



Important!

If the drip tray is not emptied regularly, the water could overflow from the edge and seep inside or around the machine.

This could damage the machine, the surface it rests on or the surrounding area.

The drip tray (A15) is fitted with a level indicator (red) showing the level of water it contains (fig. 19).

Before the indicator protrudes from the cup tray (A14), the drip tray must be emptied and cleaned.

To remove the drip tray:

1. Remove the drip tray and the grounds container (fig. 18);
2. Empty the drip tray and grounds container and wash them;
3. Replace the drip tray and grounds container.

13.4 Cleaning the inside of the machine



Danger of electric shock!

Before cleaning internal parts, the machine must be turned off (see "6. TURNING THE APPLIANCE OFF") and unplugged from the mains power supply.

Never immerse the coffee maker in water.

1. Check regularly (about once a month) that the inside of the appliance (accessible after removing the drip tray - A15) is not dirty. If necessary, remove coffee deposits with a brush and a sponge.
2. Remove the residues with a vacuum cleaner (fig. 20).

13.5 Cleaning the water tank

1. Clean the water tank (A12) regularly (about once a month and whenever you replace the water softener filter, if provided) with a damp cloth and a little mild washing up liquid.
2. Fill the tank with fresh water and put back in the appliance.

13.6 Cleaning the coffee spouts

1. Clean the coffee spouts with a sponge or cloth (A18-fig. 21).
2. Check the holes in the coffee spout are not blocked. If necessary, remove coffee deposits with a toothpick (fig. 22).

13.7 Cleaning the pre-ground coffee funnel

Check regularly (about once a month) that the pre-ground coffee funnel (A8) is not blocked.

If necessary, remove coffee deposits with a brush.

13.8 Cleaning the infuser

The infuser (A20) must be cleaned at least once a month.



Important!

The infuser may not be extracted when the machine is on.

1. Make sure the machine is correctly turned off (see "6. TURNING THE APPLIANCE OFF").
2. Open the service door (A16).
3. Extract the drip tray (A15) and the grounds container (A17) (fig. 18).
4. Press the two red release buttons inwards and at the same time pull the infuser outwards (fig. 23).

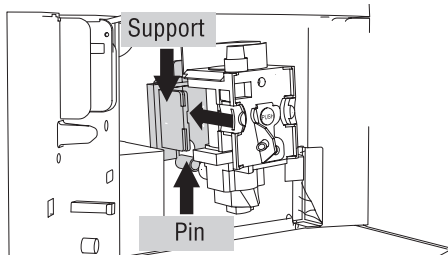

Important!

RINSE WITH WATER ONLY NO WASHING UP LIQUID - NO DISH WASHER

Do not use washing up liquid to clean the infuser as it could cause damage.

5. Soak the infuser in water for about 5 minutes, then rinse under the tap.
6. After cleaning, replace the infuser by sliding it onto the internal support and pin at the bottom, then push the PUSH symbol fully in until it clicks into place.

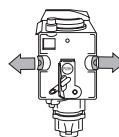

Please note!

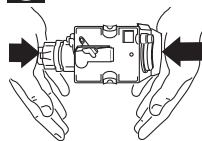

If the infuser is difficult to insert, before insertion, adapt it to the right size by pressing the two levers shown in the figure.

7. Once inserted, make sure the two red buttons have snapped out.
8. Replace the drip tray and grounds container.
9. Close the service door.

14. DESCALING

Descal the appliance when the  light (B15) on the panel flashes.



Important!

- Descaler contains acids which may irritate the skin and eyes. It is vital to respect the manufacturer's safety warnings given on the descaler pack and the warnings relating to the procedure to follow in the event of contact with the skin and eyes.
- You should use De'Longhi descaler only. Using unsuitable descaler and/or performing descaling incorrectly may result in faults not covered by the manufacturer's guarantee.

1. Turn the machine on.
2. Empty the water tank (A12).
3. Pour the descaler diluted with water (respecting the proportions indicated on the descaler pack) into the water tank.

Place an empty container with a minimum capacity of 57.48 fl.oz./1.7 litres under the hot water spout (A18).

- Wait for the ☕ (B2) and ☕☕ (B4) lights to come on steadily.



Important! Danger of burns!

Hot water containing acid flows from the cappuccino maker (A9). Avoid contact with splashes of water.

- Press the ☕/☕ button (B14) and hold it down for at least 5 seconds to confirm that you have added the solution and begin the descaling procedure. The light in the button remains on steadily to indicate that the descaling programme has begun. The ☕, ☕☕ and ☕☕☕ (B6) lights flash simultaneously telling you to turn the steam knob to the I position (coffee cannot be made).
- Turn the steam/hot water knob (B10) anticlockwise to the I position. The descaler solution flows out of the cappuccino maker into the underlying container.

The descale programme automatically performs a series of rinses and pauses to remove limescale deposits from inside the machine.

After about 30 minutes, the water tank is empty, the ☕☕☕ (B11) light comes on and the ☕, ☕☕ and ☕☕☕ lights alternate. Turn the steam/hot water knob clockwise as far as it will go to the 0 position.

The appliance is now ready for rinsing through with clean water.

- Empty the container used to collect the descaler solution and replace it empty under the cappuccino maker.
- Remove the water tank, empty, rinse under running water, fill with clean water and replace. The ☕, ☕☕ and ☕☕☕ lights flash simultaneously.
- Turn the steam/hot water knob a half turn anticlockwise to the I position. Hot water comes out of the spout.
- When the water tank is completely empty, the ☕/☕ light goes out and the ☕☕☕ and ☕☕☕☕ lights flash.
- Turn the knob to the 0 position, fill the water tank again and the appliance goes off automatically.

To use the appliance, turn it on by pressing the ⏻ (B1) button.



Please note!

If the descaling cycle is not completed correctly (e.g. lack of electricity) we recommend repeating the cycle.

15. SETTING WATER HARDNESS

The ☕/☕ light (B15) comes on after a period of time established according to water hardness.

The machine is set by default for a hardness value of 4 (very hard water).

The machine can also be programmed according to the hardness of the mains water in the various regions so that the machine needs to be descaled less often.

15.1 Measuring water hardness

- Remove the "TOTAL HARDNESS TEST" indicator paper attached to this manual from its pack.
- Immerse the paper completely in a glass of water for one second.
- Remove the paper from the water and shake lightly. After about a minute, 1, 2, 3, or 4 red squares form, depending on the hardness of the water. Each square corresponds to one level.

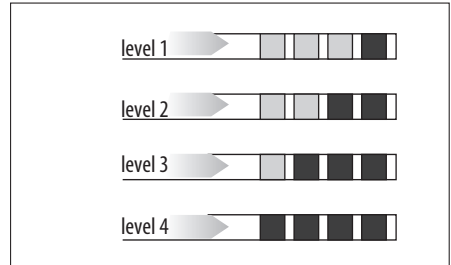

15.2 Set water hardness

- Make sure the appliance is off (but connected to the mains electricity supply and with the main switch (in the I position) (A2-fig. 3));
- Press and hold the ☕/☕ button (B14) for at least 6 seconds. The ☕☕☕, ☕☕☕☕, ☕☕☕☕☕ and ☕☕☕☕☕☕ lights (B11, B12, B13 and B14) come on simultaneously;
- Press the ECO button (B16) to set the actual water hardness (as measured by the indicator paper).

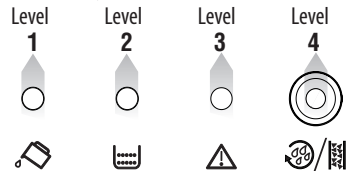













- Press the ☕/☕ button to exit the menu.

The machine is now reprogrammed with the new water hardness setting.



























16. TECHNICAL SPECIFICATION









Voltage:	120 V
Absorbed power:	1350 W
Pressure:	1,5 MPa (15 bar)
Water tank capacity:	1,7 L
Size: LxHxD:	280x364x400 mm
Cable length:	1110 mm
Weight:	10,8 kg

17. MEANING OF LIGHTS DURING NORMAL OPERATION

LIGHTS	DESCRIPTION	MEANING
1 	The lights flash (B2 and B4)	The coffee maker is not ready to make coffee (the water has not yet reached the ideal temperature). Wait for the lights to come on steadily before making coffee or (if the appliance is too hot to make coffee) open the steam/hot water knob and let the water flow out of the cappuccino maker into a container until the lights  and  stop flashing
2 	The lights are on steadily	The coffee maker is at the right temperature and ready to make coffee
3 	The light is on steadily	The appliance is delivering one cup of coffee
4 	The light is on steadily	The appliance is delivering two cups of coffee
5 	The steam light is flashing (B6)	The coffee maker is heating up to the ideal temperature to produce steam. Wait for the light to remain on steadily before using the steam function
6 	The steam light is on steadily	The appliance is ready to deliver steam
7 	The lights flash alternately	The appliance is turning off (see the section "6. TURNING THE APPLIANCE OFF")
8 	The lights flash	You must turn the steam/hot water knob to position I
9 	The lights flash alternately	You must turn the steam/hot water knob to position 0
10 	The light (B17) is on steadily	The appliance is in energy saving mode
11 	The light (B15) is on steadily	The automatic descaling programme is underway

18. MEANING OF THE ALARM LIGHTS

LIGHTS	DESCRIPTION	MEANING	WHAT TO DO
1     	The light (B11) is on steadily	Insufficient water in tank or tank not correctly in place	Fill the tank (A12) with water and/or insert it correctly, pushing it as far as it will go until it clicks into place.
		The tank is dirty and/or clogged	Rinse or descale the tank
2     	The light flashes	The grinding is too fine and the coffee is delivered too slowly	Repeat coffee delivery and turn the grinding adjustment knob (A1) (fig. 10) one click clockwise towards "7" while the coffee mill is in operation. If after making at least 2 coffees delivery is still too slow, repeat the correction procedure, turning the grinding adjustment knob another click until delivery is correct (see the section "10.3 Adjusting the coffee mill").
		The machine is not able to make coffee	If the problem persists, turn the steam/hot water knob (B10) to the I position and deliver water from the cappuccino maker (A9)
3     	The light (B12) is on steadily	The grounds container is full or missing	Empty the grounds container (A15) and drip tray (A17), clean and replace (fig. 18). Important: when removing the drip tray, the grounds container MUST be emptied, even if it contains few grounds. If this is not done, when you make the next coffees, the grounds container may fill up more than expected and clog the machine
4     	The light flashes	The "pre-ground coffee" function  has been selected without placing any pre-ground coffee in the funnel	Place pre-ground coffee in the funnel (A8) or deselect the "pre-ground" function
		The coffee beans have run out	Fill the beans container (A3)
		If the coffee mill is very noisy, this means a small stone in the coffee beans has blocked the mill.	Contact Customer Services
5     	The light (B15) flashes	The machine must be descaled	The descaling procedure described in the section "14. DESCALING" needs to be performed as soon as possible.

<p>6</p> 	<p>There is an unusual noise and the lights flash alternately</p>	<p>The infuser has not been replaced after cleaning</p>	<p>Leave the service door (A16) closed and the infuser (A20) out of the coffee maker. Press the  (B3) or   (B5) buttons together until the four lights go off. Only when all four lights are off can the door be opened and the infuser inserted.</p>
<p>7</p> 	<p>The lights flash alternately</p>	<p>The coffee maker has just been turned on, the infuser is not inserted correctly and the service door is not correctly closed.</p>	<p>Press the word PUSH on the infuser (A20) until it clicks into place. Make sure the two red buttons have snapped out. Close the service door and turn the appliance on again</p>
<p>8</p> 	<p>The lights flash</p>	<p>The pre-ground coffee funnel is clogged</p>	<p>Empty the funnel (A8) with the help of a brush as described in the section "13.7 Cleaning the pre-ground coffee funnel".</p>
<p>9</p> 	<p>The light (B13) is on steadily</p>	<p>The infuser has not been replaced after cleaning.</p>	<p>Insert the infuser (A20) as described in the paragraph "13.8 Cleaning the infuser"</p>
<p>10</p> 	<p>The light flashes</p>	<p>The service door is open</p>	<p>If you cannot close the door (A16), make sure the infuser (A20) is correctly inserted</p>
<p>11</p> 	<p>The lights flash alternately</p>	<p>The coffee maker has been switched on with the steam knob in the open position</p>	<p>You must turn the steam/hot water knob (B10) to position 0</p>

19. TROUBLESHOOTING

Below is a list of some of the possible malfunctions.

If the problem cannot be resolved as described, contact Customer Services.

PROBLEM	POSSIBLE CAUSE	SOLUTION
<p>The coffee is not hot</p>	<p>The cups were not preheated.</p>	<p>Warm the cups by rinsing them with hot water (N.B. you can use the hot water function).</p>
	<p>The infuser has cooled down because 2/3 minutes have elapsed since the last coffee was made.</p>	<p>Before making coffee, heat the infuser (A20) by pressing the  button (B14).</p>
<p>The coffee is weak or not creamy enough.</p>	<p>The coffee is ground too coarsely.</p>	<p>Turn the grinding adjustment knob (A1) one click anticlockwise towards "1" while the coffee mill is in operation (fig. 7). Continue one click at a time until coffee delivery is satisfactory. The effect is only visible after delivering 2 coffees (see the section "10.3 Adjusting the coffee mill").</p>
	<p>The coffee is unsuitable.</p>	<p>Use pre-ground coffee for espresso coffee makers</p>

The coffee is delivered too slowly or a drop at a time.	The coffee is ground too finely.	Turn the grinding adjustment knob (A1) one click clockwise towards "7" while the coffee mill is in operation (fig. 7). Continue one click at a time until coffee delivery is satisfactory. The effect is only visible after delivering 2 coffees (see the section "15. SETTING WATER HARDNESS").
Coffee does not come out of one of the spouts.	The spouts are blocked.	Clean the spouts (A18) with a toothpick (fig. 22).
The coffee does not come out of the spouts, but from around the service door.	The holes in the spouts are clogged with dry coffee dust	The coffee guide inside the service door is blocked and cannot swing.
	Clean the spouts (A18) with a toothpick, sponge or hard bristled kitchen brush (fig. 21 and 22)	Thoroughly clean the coffee guide (A19), particularly near the hinges.
The frothed milk has large bubbles	The milk is not cold enough or is not semi-skimmed.	You should ideally use skimmed or semi-skimmed milk at refrigerator temperature (about 5°C). If the result is not as you wished, try changing brand of milk.
The milk is not frothed	Cappuccino maker (A9) dirty.	Clean as described in the section "11.1 Cleaning the cappuccino maker after use".
Steam delivery stops	A safety device stops steam delivery after 3 minutes.	Wait, then activate the steam function again.
The appliance does not come on.	It is not plugged into the mains socket.	Plug into the mains socket.
	The main switch (A2) is not turned on.	Place the main switch in the I position (fig. 3).
When the steam/hot water knob is turned to the I position, steam/hot water is not delivered from the cappuccino maker	The holes in the cappuccino maker (A9) and/or steam nozzle (A10) are blocked	Clean the cappuccino maker as described in the section "11.1 Cleaning the cappuccino maker after use"
The infuser assembly cannot be removed for cleaning.	The appliance is on or has not completed the turning off cycle.	The infuser (A20) can only be removed when the appliance has been turned off correctly (see the section "6. TURNING THE APPLIANCE OFF").