

CONTENTS

1. INTRODUCTION	7
1.1 Letters in brackets.....	7
1.2 Troubleshooting and repairs.....	7
2. DESCRIPTION	7
2.1 Description of the appliance	7
2.2 Description of touch screen	7
2.3 Description of the accessories.....	7
2.4 Description of the milk container	8
2.5 Description of hot water spout.....	8
3. SETTING UP THE APPLIANCE	8
4. TURNING THE APPLIANCE ON	8
5. TURNING THE APPLIANCE OFF	8
6. MENU SETTINGS	9
6.1 Rinsing.....	9
6.2 Language.....	9
6.3 Maintenance	9
6.4 General	10
6.5 Statistics	10
7. MAKING COFFEE	11
7.1 Temporarily varying the coffee aroma.....	11
7.2 Making automatic recipes using coffee beans	11
7.3 Making coffee using pre-ground coffee.....	12
7.4 Adjusting the coffee mill	12
7.5 Tips for a hotter coffee.....	12
8. CARAFE OF COFFEE	13
9. MAKING CAPPUCCINOS AND MILK-BASED COFFEES	13
9.1 Filling and attaching the milk container.....	13
9.2 Adjust the quantity of froth.....	13
9.3 Making cappuccino and milk-based coffees automatically.....	13
9.4 Cleaning the milk container after every use	14
10. PROGRAMMING AND SELECTING	14
11. DELIVERING HOT WATER	14
12. CLEANING	15
12.1 Cleaning the machine	15
12.2 Cleaning the internal circuit	15
12.3 Cleaning the coffee grounds container.....	15
12.4 Cleaning the drip tray and drip tray grille....	15
12.5 Cleaning the inside of the appliance	15
12.6 Cleaning the water tank	15
12.7 Cleaning the coffee spouts	16
12.8 Cleaning the pre-ground coffee funnel	16
12.9 Cleaning the infuser	16
12.10 Cleaning the milk container (D).....	16
12.11 Cleaning the hot water nozzle.....	17
12.12 Cleaning the hot water spout	17
13. DESCAL	17
14. SETTING WATER HARDNESS	18
14.1 Measuring water hardness.....	18
14.2 Setting water hardness	18
15. WATER SOFTENER FILTER	18
15.1 Installing the filter	18
15.2 Replacing the filter	19
15.3 Removing the filter	19
16. TECHNICAL DATA	20
16.1 Tips for Energy Saving	20
17. DISPLAYED MESSAGES	20
18. TROUBLESHOOTING	22

Before using the appliance, always read the safety warnings.

1. INTRODUCTION

Thank you for choosing this bean to cup espresso and cappuccino machine.

We hope you enjoy using your new appliance. Take a few minutes to read this Instruction for Use. This will avoid all risks and damage to the appliance.

1.1 Letters in brackets

The letters in brackets refer to the legend in the description of the appliance on pages 2-3.

1.2 Troubleshooting and repairs

In the event of problems, first try and resolve them by reading the information given in sections "17. Displayed messages" and "18. Troubleshooting".

If this does not resolve the problem or you require further information, you should consult Customer Services by calling the number given on the annexed "Customer Service" sheet.

If your country is not among those listed on the sheet, call the number given in the guarantee. If repairs are required, contact De'Longhi Customer Services only. The addresses are given in the guarantee certificate provided with the machine.

2. DESCRIPTION





2.1 Description of the appliance

(page 3 - A)







- A1. Beans container
- A2. Beans container lid
- A3. Cover for funnel and measure compartment
- A4. Pre-ground coffee funnel (removable)
- A5. Compartment for measure
- A6. Cup shelf (cup warmer when Energy Saving is disabled)
- A7. ON/STANDBY button
- A8. Grinding adjustment dial
- A9. Main switch (on back of machine)
- A10. Power cord
- A11. Water tank lid
- A12. Water tank
- A13. Water softener filter compartment
- A14. Service door (access to the grounds container and infuser)
- A15. Hot water connection nozzle
- A16. Coffee spouts (adjustable height)
- A17. Infuser (accessible when service door is open)
- A18. Coffee guide (inside the service door)
- A19. Cup tray
- A20. Drip tray water level indicator
- A21. Tray grille
- A22. Drip tray
- A23. Coffee grounds container

2.2 Description of touch screen

(page 2 - B)

- B1. Display
- B2. /ESB: appliance settings menu / press to exit the menu
- B3. /◀: My beverages selection menu. The beverage is programmed directly the first time you use the appliance / Scroll arrow
- B4. /☑: To confirm the selection / Aroma selection
- B5. /☑: Scroll arrow / Beverage selection menu (other than directly selected beverages):

Beverage	ESAM42X.4Y	ESAM42X.8Y
2 espressos	•	•
Ristretto	•	•
2 Ristretto	•	•
Espresso Lungo	•	•
2 Espresso Lungo	•	•
Long	•	(direct selection button)
Doppio+	•	•
Caffelatte	•	•
Hot Milk	•	(direct selection button: Milk)
Hot Water	•	•
Coffee Pot	•	•
Flat White	-	•
Cappuccino+	-	•

- B6.  Espresso: to deliver a cup of espresso coffee
- B7.  Coffee: to deliver a cup of coffee
- B8.  Cappuccino: to deliver a cup of cappuccino
- B9.  Macchiato: to deliver a cup of macchiato
- B10.  Long: to deliver a cup of long coffee
- B11.  Milk: to deliver a cup of hot milk

*Model ESAM42X.8Y only

Please note:

A light touch is enough to activate the icon.

2.3 Description of the accessories

(page 2 - C)

- C1. "Total Hardness Test" indicator paper
- C2. Pre-ground coffee measure
- C3. Descaler
- C4. Water softener filter (if present)
- C5. Cleaning brush
- C6. Carafe* (model ESAM42X.8Y only)

2.4 Description of the milk container

(page 2 - D)

- D1. Lid with milk frother
- D2. Froth adjustment and CLEAN dial
- D3. Frothed milk spout
- D4. Lid release buttons
- D5. Milk intake tube
- D6. Milk container
- D7. Milk intake tube (under lid)

2.5 Description of hot water spout





(page 2 - E)

- E1. Release button
- E2. Spout
- E3. Hot water connection nozzle
- E4. Removable cover



3. SETTING UP THE APPLIANCE

Please note:

- The first time you use the appliance, rinse with hot water all removable accessories which may come into contact with water or milk.
- The first time you use the machine, the water circuit is empty and the appliance could be very noisy. The noise becomes less as the circuit fills.
- Coffee has been used to factory test the appliance and it is therefore completely normal for there to be traces of coffee in the mill. The machine is, however, guaranteed to be new.





1. Connect the appliance to the mains electricity supply (fig. 1) and make sure the main switch (A9) at the back of the appliance is in the I position (fig. 2);
2. "Language": press the scroll arrows  / ◀ (B3) or ▶ /  (B5) until the required language is displayed, then press  /  (B4) to confirm.

Follow the instructions indicated on the appliance display:



3. Remove the water tank (A12) (fig. 3), fill to the MAX line (marked on the tank) with fresh water (fig. 4, then put the tank back in the appliance (fig. 5);
4. Check that the hot water spout (E) is inserted on the connection nozzle (A15) (fig. 6) and place a container holding a minimum of 600 ml underneath (fig. 7);
5. Press  /  (B4) to confirm: The appliance delivers water from the spout (fig. 8) then goes off automatically.

Now rinse the milk circuit as follows:

6. Turn the machine on again by pressing the  button (A7) (fig. 9). The appliance performs an automatic preheat and rinse cycle which cannot be interrupted;
7. Fill the milk container (D6) with water up to the MAX level;

8. Place the lid back on the milk container;
9. If present, extract the hot water spout by pressing the release button (E1) (fig. 18);
10. Attach the container to the connection nozzle and push as far as it will go (fig. 19). The machine emits a beep (if enabled);
11. Turn the froth adjustment dial (D2) to the  (no froth) position;
12. Place a container with a minimum capacity of 600 ml under the milk spout (D3);
13. Now deliver three consecutive "Hot milks":
 - **ESAM42X.4Y:** Press  (B5) and select "Hot milk". Then confirm by pressing  /  (B4).
 - **ESAM42X.8Y:** Press  (B11).

Please note:

At the end of each delivery, press  /  (B2) to cancel the clean milk container message.

14. Extract the milk container.
The coffee machine is now ready for normal use.

Please note:

- The first time you use the appliance, you need to make 4 - 5 espresso coffees before it starts to give satisfactory results.
- 1. To enjoy your coffee even more and improve the performance of your appliance, we recommend installing a water softener filter (C4) as described in section "15. Water softener filter". If your model is not provided with a filter, you can request one from De'Longhi Customer Services.

4. TURNING THE APPLIANCE ON

Please note:

Before turning the appliance on, make sure the main switch (A9) on the back of the appliance is pressed (fig. 2).

Each time the appliance is turned on, it performs an automatic preheat and rinse cycle which cannot be interrupted. The appliance is ready for use only after completion of this cycle.

Danger of burns!

During rinsing, a little hot water comes out of the coffee spouts (A16) and is collected in the drip tray (A22) underneath. Avoid contact with splashes of water.

- To turn the appliance on, press the  button (A7) (fig. 9).
- After heating, the appliance automatically performs a rinse cycle. As well as heating the boiler, this also heats the internal circuits by circulating hot water.

The appliance is ready for use when the main screen appears.

5. TURNING THE APPLIANCE OFF

Whenever the coffee machine is turned off after being used to make coffee, it performs an automatic rinse cycle.

1. To turn the appliance off, press the  button (A7) (fig. 9).
2. If provided for, the appliance performs a rinse cycle then goes off (stand-by).

Please note:

If you will not be using the appliance for some time, unplug from the mains socket:

1. First turn the appliance off by pressing the  button (A7) (fig. 9);
2. Press the main switch (A9) at the back of the appliance (fig. 2) to the 0 position.

Important!

Never press the main switch while the appliance is on.









6. MENU SETTINGS

The menu has 5 items, some divided into subgroups:

- Rinsing;
- Language;
- Maintenance:
 - Descale,
 - Install filter,
 - (if a filter has been installed): Replace filter,
 - (if a filter has been installed): Remove filter;
 - Emptying the circuit;
- General:
 - Set temperature,
 - Water hardness,
 - Auto-off,
 - Energy saving,
 - Beep,
 - Default beverages,
 - Default values;
 - Statistics.

6.1 Rinsing

Use this function to deliver hot water from the coffee spouts (A16) and hot water spout (E) (if inserted) to clean and heat the appliance's internal circuit.

1. Place a container with a minimum capacity of 200ml under the coffee and hot water spouts (fig. 10);
2. Press  (B2) to enter the menu;
3. Press the scroll arrows  /  (B3) or  /  (B5) until the required item is displayed;
4. Press  /  (B4): after a few seconds, hot water is delivered first from the coffee spouts, then from the hot water spout (if inserted) to clean and heat the appliance's internal circuit;
5. To stop rinsing, press  or wait for rinsing to stop automatically.















Please note:

- If the appliance is not used for more than 3-4 days, when you turn it on again, we strongly recommend performing 2/3 rinses before use;

- After cleaning, it is normal for the grounds container (A23) to contain water.

6.2 Language

To modify the language of the display (D6), proceed as follows:

















1. Press  (B2) to enter the menu;
2. Press the scroll arrows  /  (B3) or  /  (B5) until the required item is displayed;
3. Press  /  (B4);
4. Press the scroll arrows  /  (B3) or  /  (B5) until the required language is displayed;
5. Press  /  (B4): The appliance goes back to the menu;
6. Then press  (B2) to exit the menu.

6.3 Maintenance













Here you can find all the maintenance operations required by the appliance over time:

- **Descaling:** For instructions on descaling, see section "13. Descale".
- **Install filter/Replace filter/Remove filter:** For instructions on how to install/replace/remove the filter (C4), see section "15. Water softener filter".
- **Emptying the circuit:**

To select the operation, proceed as follows:

1. Press  (B2) to enter the menu;
2. Press the scroll arrows  /  (B3) or  /  (B5) until "Maintenance" is displayed;
3. Press  /  (B4);
4. Press the scroll arrows  /  (B3) or  /  (B5) until the required item is displayed;
5. Press  /  to select;
6. Press  /  to confirm or  /  to go back to the previous screen;

Follow the guided procedure:

7. Extract and empty the coffee grounds container (A23). Press  / ;
8. Empty the drip tray (A22) and put back in the appliance complete with grounds container and grille (A21). Press  / ;
9. Place a container under the coffee spouts (A16) and hot water spout (E). Press  / ;
10. The appliance performs a rinse cycle from the coffee spouts;
11. Extract the tank (A12), empty it completely then press  / ;
12. (If the filter is installed) Remove the filter (C4) from the tank, then press  / ;
13. Put the tank back, then press  / ;
14. Wait for the appliance to empty the circuit; (Important: hot water from the spouts!). As the water circuit empties, the appliance could become noisier. This is part of normal operation.

15. Extract, empty and reposition the drip tray, then press OK/ECO ;
16. At the end of the sequence, press OK/ECO . The appliance goes off.

Please note:

When turned on again the appliance asks for the circuit to be filled: follow the instructions from point 3 of section "3. Setting up the appliance".

6.4 General

Here you can find the settings to customise the basic functions of the appliance:

1. Press OK/ESC (B2) to enter the menu;
2. Press the scroll arrows MV/LEFT (B3) or RIGHT/MENU (B5) until "General" is displayed;
3. Press OK/ECO (B4) to confirm;
4. Press the scroll arrows MV/LEFT or RIGHT/MENU until the required item is displayed:

Set temperature:

To change the temperature of the water used to make the coffee, proceed as follows:

- Press OK/ECO (B4). The current value appears on the display (D6) and the "New" value flashes;
- Select the new value you want to set using the scroll arrows MV/LEFT (B3) or RIGHT/MENU (B5);
- 5. When the required value (low, medium, high) has been selected, press OK/ECO .

The display goes back to the previous screen.

Please note:

Varying the temperature has most effect for long beverages.

Water hardness

For instructions on identifying and setting water hardness, see section "16. Setting water hardness".

Auto-off (standby):

Auto-off can be set so that the appliance goes off after 15 or 30 minutes, or 1, 2 or 3 hours

- Press OK/ECO (B4). The current value appears on the display (B1) and the "New" value flashes;
- Select the new value you want to set using the scroll arrows MV/LEFT (B3) or RIGHT/MENU (B5);
- When the required value (15 min, 30 min, 1 hour, 2 or 3 hours) has been selected, press OK/ECO .

The display goes back to the previous screen.

Energy saving:

To disable or enable "Energy Saving", proceed as follows:

- Press OK/ECO (B4). The current state ("Enabled" or "Disabled") and the operation to be performed ("Disable?" or "Enable?") by confirming with OK/ECO appear on the display (D6);

- Press OK/ECO to disable or enable the function.

The display goes back to the previous screen.

Please note:

- when the function is enabled, the "ECO" symbol appears on the display.
- When in energy saving mode, a few seconds elapse before the first coffee, cappuccino or milk-based coffee is delivered as the appliance must heat up again.
- If the milk container (D) is inserted, "Energy Saving" has no effect.

Beep:

Use this function to enable or disable the beep. Proceed as follows:

- Press OK/ECO (B4). The current state ("Enabled" or "Disabled") and the operation to be performed ("Disable?" or "Enable?") by confirming with OK/ECO appear on the display (D6);
- Press OK/ECO to disable or enable the function.

The display goes back to the previous screen.

Default beverages

Use this function to reset the default values for all the beverages, or the individual previously customised beverages.

- Press OK/ECO (B4). The previously customised beverages and "All" appear on the display (D6);
- Select "All" to reset the aroma and quantity settings of all beverages to the default values, or select the required beverage, then press OK/ECO ;
- To reset the default values, press OK/ECO .
- The appliance confirms the reset and goes back to the previous screen.

Reset another beverage or press OK/ESC (B2) to exit the menu.

Default values:

Use this function to reset all the appliance and beverage settings (apart from the language which remains as selected the first time the appliance was used).

4. Press OK/ECO (B4);
5. Press OK/ECO to reset all the settings;
6. The appliance confirms the reset and goes back to the previous screen.

Press OK/ESC (B2) to exit the menu.

6.5 Statistics

This displays statistics relating to the machine. To view the statistics, proceed as follows:

1. Press OK/ESC (B2) to enter the menu;
2. Press the scroll arrows MV/LEFT (B3) or RIGHT/MENU (B5) until "Statistics" is displayed;
3. Press OK/ECO (B4): statistics on the appliance appear on the display (D6), use the scroll arrows MV/LEFT or RIGHT/MENU to scroll through the items;

4. Then press /ESC to exit.
To go back to the main screen, press /ESC again.

7. MAKING COFFEE

7.1 Temporarily varying the coffee aroma

To temporarily vary the aroma of the coffee in the automatic recipes, press / (B4):

	Custom (if programmed) / Standard
	EXTRA MILD
	LIGHT
	MEDIUM
	STRONG
	EXTRA STRONG
	(see "7.3 Making coffee using pre-ground coffee")

Please note:

- The variation in aroma is not saved and the next time a beverage is delivered automatically, the appliance selects the default value ().
- If a few seconds elapse between temporary customising of the aroma and delivery of the beverage, the aroma returns to the default value ().

7.2 Making automatic recipes using coffee beans

Important!

Do not use green, caramelised or candied coffee beans as they could stick to the coffee mill and make it unusable.

1. Fill the container (A1) with coffee beans (fig. 10);
2. Place under the coffee spouts (A16):
 - 1 cup, if you want to make 1 coffee (fig. 11);
 - 2 cups, if you want to make 2 coffees (see note at end of section).
3. Lower the spouts as near as possible to the cup. This makes a creamier coffee (fig. 12);
4. Then select your required coffee:

Directly selected beverages			
Recipe	Quantity	Program- mable quantity	Default aroma
(B6)	≈ 40 ml	from ≈30 to ≈ 80ml	
(B7)	≈ 180 ml	f r o m ≈100 to ≈240ml	
Model ESAM42X.8Y only			
(B10)	≈ 160 ml	f r o m ≈115 to ≈250ml	
Coffees selectable from (B5) and confirming with / (B4)			
Ristretto	≈ 30 ml	from ≈20 to ≈40ml	
Espresso Lungo	≈ 120 ml	from ≈80 to ≈180ml	
Doppio+	≈ 120 ml	from ≈80 to ≈180ml	+
2 Espresso	≈ 40 ml x 2 cups	--	
2 Ristretto	≈ 30 ml x 2 cups	--	
2 Espresso Lungo	≈ 120 ml x 2 cups	--	
Long * (model ESAM42X.4Y only)	≈ 160 ml	f r o m ≈115 to ≈250ml	

5. Preparation begins. The selected beverage appears on the display (D6) together with a progress bar which gradually fills as preparation proceeds.

Please note:

- You can prepare 2 cups of ESPRESSO, RISTRETTO or ESPRESSO LUNGO coffee at the same time by pressing "X2" / (B5) during preparation of single beverages (the message is displayed for a few seconds at the start of preparation).
- While the machine is making coffee, delivery can be interrupted at any moment by pressing "STOP"-/ (B5) or /ESC (B2).

- At the end of delivery, to increase the quantity of coffee in the cup, just press "EXTRA" ►/☞ (B4) within 3 seconds. When the required quantity is reached, press "STOP" my / ◀ (B5).

Once the coffee has been made, the appliance is ready to make the next beverage.



Please note:

- Various alarm messages could be displayed while using the appliance (Fill tank, Empty grounds container, etc.). Their meaning is explained in section "18. Troubleshooting".
- For hotter coffee, see section "7.5 Tips for a hotter coffee".
- If the coffee is delivered a drop at a time, too weak and not creamy enough or too cold, read the tips in section "18. Troubleshooting".
- To customise the beverages according to personal taste, see section "10. Programming and selecting".

7.3 Making coffee using pre-ground coffee

Important!

- Never add pre-ground coffee when the machine is off or it could spread through the inside of the machine and dirty it. This could damage the machine.
 - Never use more than 1 level measure (C2) as it could soil the inside of the coffee machine or block the funnel (A4).
 - When using pre-ground coffee, only one cup can be made at a time.
- Press the ok / ●● (B4) button repeatedly until "☞" appears on the display (D6);
 - Make sure the funnel is not blocked, then add one level measure of pre-ground coffee;
 - Place a cup under the coffee spouts (A16) (fig. 12);
 - Then select your required coffee:

Recipe	Quantity
 Espresso (B6)	≈ 40 ml
 Coffee (B7)	≈ 180 ml
Model ESAM42X.8Y only	
 Long (B10)	≈ 160 ml
Coffees selectable from ☞ (B5) and confirming with ok / ●● (B4)	
Ristretto	≈ 30 ml
Espresso lungo	≈ 120 ml

Coffees selectable from ☞ (B5)	
Long * (model ESAM42X.4Y only)	≈ 160 ml

- Preparation begins. The selected beverage appears on the display, together with a progress bar which gradually fills as preparation proceeds.

Please note:

At the end of delivery, to increase the quantity of coffee in the cup, just press "EXTRA" ►/☞ (B5) within 3 seconds. When the required quantity is reached, stop with my / ◀ (B3).

Important! Making ☞ LONG coffee:

Halfway through preparation, the machine requests a further level measure of pre-ground coffee. Proceed, then press ok / ●● (B4).

Please note:

- If "Energy Saving" mode is active, you may have to wait a few seconds before the first coffee is delivered.
- Various alarm messages could be displayed while using the appliance (Fill tank, Empty grounds container, etc.). Their meaning is explained in section "18. Troubleshooting".
- For hotter coffee, see section "7.5 Tips for a hotter coffee".
- If the coffee is delivered a drop at a time, too weak and not creamy enough or too cold, read the tips in section "18. Troubleshooting".

7.4 Adjusting the coffee mill

The coffee mill is factory-set in such a way that the coffee will be delivered correctly, and should not require regulating initially. However, if after making the first few coffees you find that the coffee is either too weak and not creamy enough or delivery is too slow (a drop at a time), this can be corrected by adjusting the grinding adjustment dial (A8) (fig. 13).

Please note:

The grinding adjustment dial must only be turned when the coffee mill is in operation during the initial phase of coffee preparation.

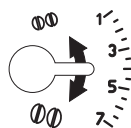

If the coffee is delivered too slowly or not at all, turn one click clockwise towards 7. For fuller bodied creamier coffee, turn one click anticlockwise towards 1 (do not turn more than one click at a time otherwise the coffee could be delivered a drop

at a time).

The effect of the adjustment will be noticed only after making a further 2 cups of coffee, at least. If this adjustment does not produce the desired result, turn the dial another click.

7.5 Tips for a hotter coffee



For hotter coffee, proceed as follows:

- perform a rinse cycle by selecting the "Rinsing" function in the settings menu (section "6.1 Rinsing");
- warm the cups with hot water using the hot water function (see section "11. Delivering hot water");
- increase the coffee temperature in the "Settings" menu (see section "6.4 General"). Varying the temperature has most effect for long beverages.























8. CARAFE OF COFFEE

Based on espresso coffee, this beverage is light and balanced, with a fine layer of froth, ideal to share in company.

1. Place a carafe under the coffee spouts (A16) (fig. 14). When choosing the carafe to use, bear in mind the quantity to be delivered, namely:

Number of cups	Quantity (ml)
	≈ 250
	≈ 500
	≈ 750

ESAM45X.8Y: Use the carafe provided (C6).

2. Press  /  (B5);
3. Press  /  (B3) or  /  until the name of the beverage is displayed;
4. Confirm by pressing  /  (B4);
5. Press  /  (B3) or  /  to select the number of cups;
6. Confirm by pressing  / ;
7. Press  /  (B3) or  /  to select the aroma;
8. Confirm by pressing  /  or  / .
9. After a few seconds, the appliance starts making the coffee automatically.

Once the coffee has been made, the appliance is ready to make the next beverage.

Please note:

-  /  (B2): press to interrupt preparation completely and be ready for use again;

SAFETY WARNING:

After making the carafe of coffee, leave the appliance to cool for 5 minutes before making another beverage. Risk of overheating!

9. MAKING CAPPUCCINOS AND MILK-BASED COFFEES

Please note:

To avoid milk with poor froth or large bubbles, always clean the milk container lid (D1) and hot water connection nozzle (A15) as described in sections "9.4 Cleaning the milk container after every use", "12.10 Cleaning the milk container (D)" and "12.11 Cleaning the hot water nozzle".

9.1 Filling and attaching the milk container



1. Press the release buttons (D4) and lift the milk container lid (D1) (fig. 15);
2. Fill the milk container (D6) with a sufficient quantity of milk, not exceeding the MAX level marked on the container (fig. 16);
3. Make sure the milk intake tube (D5) is correctly inserted as far as it will go in the bottom of the milk container lid (fig. 17);
4. Place the lid back on the milk container;
5. If present, extract the hot water spout (E) by pressing the release button (E1) (fig. 18);
6. Attach the container to the connection nozzle (A15) and push as far as it will go (fig. 19). The machine emits a beep (if enabled);
7. Place a sufficiently large cup under the coffee spouts (A16) and frothed milk spout (D3);
8. Follow the instructions below for each function.

Please note:

- For a denser more even froth, you must use skimmed or partially skimmed milk at refrigerator temperature (about 5°C).
- The quality of the froth will vary depending on:
 - type of milk or vegetable beverage;
 - brand used;
 - ingredients and nutritional value.
- If "Energy Saving" mode is enabled, you may have to wait a few seconds before the beverage is delivered.

9.2 Adjust the quantity of froth

Turn the froth adjustment dial (D2) to adjust the amount of froth on the milk delivered while making cappuccinos and milk-based coffees.

Dial position	Description	Recommended for...
	No froth	HOT MILK (not frothed) / CAFFELATTE
	Min. froth	LATTE MACCHIATO/ FLAT WHITE*



	Max. froth	CAPPUCCINO/CAPPUCCI-NO+* / HOT MILK (frothed)
---	------------	---

* (model ESAM42X.8Y only)

9.3 Making cappuccino and milk-based coffees automatically

1. Fill the milk container (D) and attach it as described above;
2. Select the required beverage:





Directly selected beverages:

- : Cappuccino (B8)
- : Macchiato (B9)
- : Milk (B11) (*ESAM42X.8Y - Hot milk)

Selectable by pressing (B5) and confirming with (B4):

- Flat white (* Model ESAM42X.8Y only)
 - Cappuccino+ (* Model ESAM42X.8Y only)
 - Hot milk (*ESAM42X.4Y - Milk)
3. After a few seconds, preparation begins automatically and the selected beverage appears on the display, together with a progress bar which gradually fills as preparation progresses;
 4. After delivering the milk, the machine automatically makes the coffee (if required by the recipe).

Please note:

-  /  (B2): press to interrupt preparation completely and go back to the main screen.
- "STOP"  /  (B3): to interrupt milk or coffee delivery and move on to the next delivery (if applicable) to complete the beverage.
- At the end of delivery, to increase the quantity of coffee in the cup, press the button corresponding to "EXTRA" -  (B5).
- Do not leave the milk container out of the refrigerator for long periods. The warmer the milk (5°C is ideal), the poorer the quality of froth produced.
- The beverages can be customised (see section "10. Programming and selecting").



9.4 Cleaning the milk container after every use

The milk frother lid must be cleaned each time you use a milk function:

1. Leave the milk container (D) in the machine (you do not need to empty it);
2. Place a cup or other recipient under the frothed milk spout;
3. Turn the froth adjustment dial (D2) to "CLEAN" (fig. 20). A progress bar appears and gradually fills as the operation proceeds together with "Cleaning underway". Cleaning stops automatically;
4. Turn the dial back to one of the froth selections;















5. Remove the milk container and always clean the steam connection nozzle (A15) with a sponge (fig. 21).



Please note:





- If you want to prepare a number of cappuccinos or milk-based coffees, clean the milk container after you have prepared the last beverage only. In this case, when requested, press  /  (B2) to go back to the main menu.
- If you do not clean the milk container, the  symbol appears on the display to remind you that it needs cleaning.
- The milk container can be kept in the refrigerator.
- In some cases, to clean you must wait for the appliance to heat up.

10. PROGRAMMING AND SELECTING

In the "my" menu you can customise the beverages according to your personal tastes.

1. Press  /  (B3);
2. Press the scroll arrows  (B3) or  (B5) until the required beverage is displayed;
3. Press  /  (B4) to select the beverage;
4. • **Beverages with coffee:** "Program aroma" appears on the display (D6). Press the scroll arrows  /  until the required aroma is selected. Press  /  to confirm the selection. Preparation begins and "Program coffee" appears on the display together with a bar which gradually fills as delivery progresses. When the required quantity is reached in the cup, press  /  (STOP).
- **Cappuccino and milk-based coffees:** after selecting and confirming the aroma, "Program milk" appears on the display together with a bar which gradually fills as milk delivery progresses. When the required quantity is reached, press  / .

The appliance then makes the coffee. Press  /  to interrupt delivery when the required quantity of coffee is reached.

5. Save the settings by pressing  /  (or press  /  (B2)).
6. "Parameters saved" or "Parameters not saved". The appliance is ready for use again.







Please note:

- When the minimum quantity you can set is reached, "STOP" appears on the display.
- "STOP": press the corresponding button to interrupt milk or coffee delivery and move on to the next delivery (if applicable) to complete the beverage.
- At the end of delivery, to increase the quantity of coffee in the cup, press the button corresponding to "EXTRA".

11. DELIVERING HOT WATER

Important! Danger of burns.

Never leave the machine unattended while delivering hot water.

1. Make sure the hot water spout (E) is attached correctly to the hot water connection nozzle (A15);
2. Place a container under the water spout (as close as possible to avoid splashes) (fig. 7);
3. Press  (B5) and scroll through the beverages in the menu by pressing the scroll arrows  /  (B3) or  (B5) until "Hot water" is displayed;
4. Press  (B4). A progress bar appears and gradually fills as preparation proceeds;
5. The machine delivers hot water, then delivery stops automatically. To interrupt delivery of hot water manually, press  /  (STOP).

Please note:

- If "energy saving" mode is active, you may have to wait a few seconds before the hot water is delivered.
- The quantity of water delivered can be customised (see section "10. Programming and selecting").

12. CLEANING

12.1 Cleaning the machine

The following parts of the machine must be cleaned regularly:

- the appliance's internal circuit;
- coffee grounds container (A23);
- drip tray (A22) and drip tray grille (A21);
- water tank (A12);
- coffee spouts (A16);
- pre-ground coffee funnel (A4);
- infuser (A17), accessible after opening the infuser door (A14);
- milk container (D);
- hot water connection nozzle (A15);
- hot water spout

Important!

- Do not use solvents, abrasive detergents or alcohol to clean the coffee machine. With De'Longhi superautomatic coffee machines, no chemical products are required for cleaning purposes.
- None of the components of the appliance can be washed in a dishwasher with the exception of the drip tray grille (A21) and milk container (D).
- Do not use metal objects to remove encrustations or coffee deposits as they could scratch metal or plastic surfaces.

12.2 Cleaning the internal circuit

If the appliance is not used for more than 3/4 days, before using it again, we strongly recommend switching it on and:

- performing 2/3 rinse cycles (see section "6.1 Rinsing");

- delivering hot water for a few seconds (section "11. Delivering hot water").

Please note:

After cleaning, it is normal for the grounds container (A23) to contain water.

12.3 Cleaning the coffee grounds container

The display indicates when the grounds container (A23) is full. The appliance cannot be used to make coffee until you have cleaned the grounds container. Even if not full, the empty grounds container message is displayed 72 hours after the first coffee has been prepared. For the 72 hours to be calculated correctly, the machine must never be turned off with the main switch in the 0).

To clean (with the machine on):

- Open the service door (A14) on the front of the appliance (fig. 22), extract the drip tray (A22) (fig. 23), empty and clean.
- Empty the grounds container and clean thoroughly to remove all residues left on the bottom. This can be done with the spatula on the brush provided.

Important!

When removing the drip tray, the grounds container **must** always be emptied, even if it has not filled up appreciably. If this is not done, when you make the next coffees, the grounds container may fill up more than expected and clog the machine.

12.4 Cleaning the drip tray and drip tray grille

The drip tray (A22) is fitted with a level indicator (A20) (red) showing the amount of water it contains (fig. 24). Before the indicator protrudes from the cup tray (A19), the drip tray must be emptied and cleaned, otherwise the water may overflow the edge and damage the appliance, the surface it rests on or the surrounding area.

To remove the drip tray:

1. Open the service door (A14) (fig. 22);
2. Remove the drip tray and coffee grounds container (A23) (fig. 23);
3. Remove the cup tray and drip tray grille (A21), then empty the drip tray and grounds container and wash all components. The grille is dishwasher safe;
4. Put the drip tray complete with grille and grounds container back in the appliance.
5. Close the service door.

12.5 Cleaning the inside of the appliance

Danger of electric shock!

Before cleaning internal parts, the machine must be turned off (see section "5. Turning the appliance off") and unplugged from the mains power supply. Never immerse the machine in water.

1. Check regularly (about once a month) that the inside of the appliance (accessible after removing the drip tray (A22)) is not dirty. If necessary, remove coffee deposits with the brush (C5) supplied and a sponge;
2. Remove all residues with a vacuum cleaner (fig. 25).

12.6 Cleaning the water tank

1. Clean the water tank (A12) regularly (about once a month) and whenever you replace the water softener filter (C4) (if provided) with a damp cloth and a little mild washing up liquid;
2. Remove the filter (C4) (if present) and rinse with running water;
3. Replace the filter (if installed), fill the tank with fresh water and replace;
4. (Models with water softener filter only) Deliver 100ml of water to reactivate the filter.

12.7 Cleaning the coffee spouts

1. Clean the coffee spouts (A16) regularly with a sponge or cloth (fig. 26A);
2. Check the holes in the coffee spouts are not blocked. If necessary, remove coffee deposits with a toothpick (fig. 26B).

12.8 Cleaning the pre-ground coffee funnel

Clean the pre-ground coffee funnel (A4) regularly (about once a month) with a damp cloth. Proceed as follows:

1. Open the lid (A3);
2. Extract the funnel (fig. 27) and clean with the brush provided (C5);
3. If necessary, clean the funnel with hot water and washing up liquid or in a dishwasher;
4. Put the funnel back in the appliance;
5. Close the lid.

12.9 Cleaning the infuser

The infuser must be cleaned at least once a month.

Important!

The infuser cannot be extracted when the machine is on.

1. Make certain that the machine has run the shutdown procedure correctly (see "5. Turning the appliance off");
2. Open the service door (A14) (fig. 22);
3. Remove the drip tray (A22) and coffee grounds container (A23) (fig. 23);
4. Press the two red release buttons inwards and at the same time pull the infuser outwards (fig. 28);

Important!

RINSE WITH WATER ONLY

NO DETERGENTS - NO DISH WASHER

Do not use detergents to clean the infuser as this could cause damage.

5. Soak the infuser in water for about 5 minutes, then rinse under the tap;
6. After cleaning, replace the infuser by sliding it onto the internal support and pin at the bottom (fig. 29), then push the PUSH symbol fully in until it clicks into place (fig. 30);

Please note:

If you encounter difficulty inserting the infuser, before inserting it you must adapt it to the right dimension by pressing it forcefully from the bottom and top (fig. 31).

7. Once inserted, make sure the two red buttons have snapped out (fig. 32).
8. Replace the drip tray and grounds container.
9. Close the service door.

12.10 Cleaning the milk container (D)

Clean the milk container each time you prepare milk as described below:

1. Press the release buttons (D4) and lift and remove the milk container lid (D1) (fig. 16);
2. Remove the milk spout (D3) and intake tube (D5) (fig. 33);
3. Make sure the hole in the milk intake tube connector (D7) is not blocked (fig. 34);

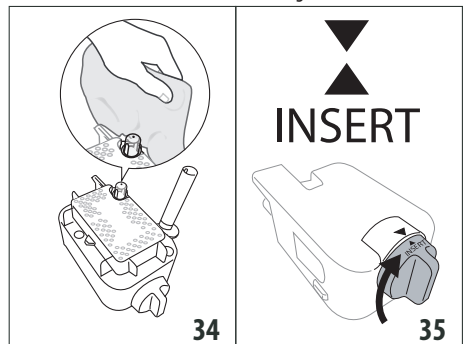
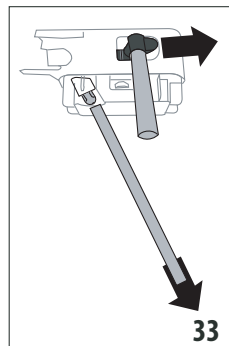

4. Turn the froth adjustment dial (D2) clockwise to the "INSERT" position (fig. 35) and pull;
5. Wash all the components of the frother thoroughly with hot water and light washing-up liquid. All components and the container are dishwasher safe, placing them in the top basket;
6. Make sure there are no milk residues on the hollow and groove under the dial (fig. 36). If necessary, scrape the groove with a toothpick;

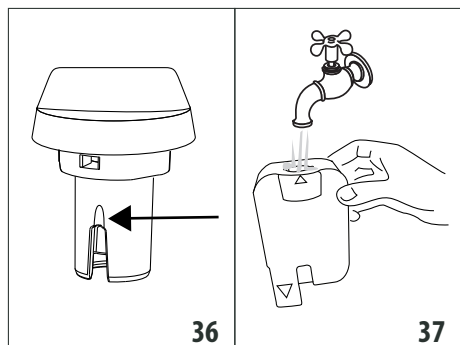

7. Rinse inside the froth adjustment dial seat and the milk frother connector hole with running water (fig. 37);
8. Check that the intake tube and spout are not clogged with milk residues;
9. Replace the dial (lining up the arrow with the word "IN-SERT"), spout and milk intake tube;
10. Attach the lid back on the milk container.

12.11 Cleaning the hot water nozzle

Every now and then, clean the connection nozzle (A15) with a sponge to remove milk residues from the gaskets (fig. 21).

12.12 Cleaning the hot water spout

Every now and then, clean the hot water spout (E) to avoid clogging.

1. Place a container under the hot water spout and deliver a little water (see section "11. Delivering hot water"). Then stop delivery of hot water by pressing / (B2);
2. Wait a few minutes for the hot water spout to cool down, then extract (fig. 19) by pressing the release buttons (E1). Hold the spout with one hand and with the other, turn the removable cover (E4) and pull downwards (fig. 38);

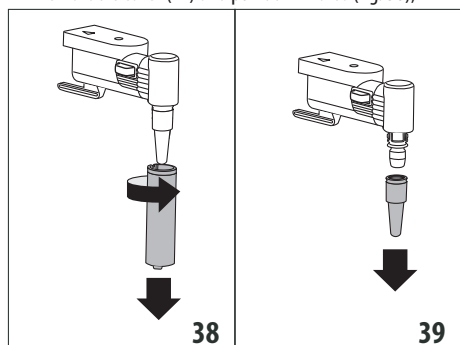

3. Also remove the connection nozzle (E3) by pulling downwards (fig. 39);
4. Check the hole in the connection nozzle is not blocked. If necessary, clean using a toothpick;

5. Wash all parts of the spout thoroughly with a sponge and warm water;
6. Insert the connection nozzle, then insert the removable cover on the nozzle by pushing it upwards and turning it clockwise until it is attached.

13. DESCAL

Important!

- Before use, read the instructions and the labelling on the descaler pack.
- It is important to use De'Longhi descaler only. Using unsuitable descaler and/or performing descaling incorrectly may result in faults not covered by the manufacturer's guarantee.
- Descaler could damage delicate surfaces. If the product is accidentally spilt, dry immediately.

To descale	
Descaler	De'Longhi descaler
Container	Recommended capacity: 2 l
Time	~45min

Descal the machine when the corresponding message appears on the display (D6). To descale immediately, press / (B4) and follow the instructions from point 6. To descale the appliance later press / (B2). The symbol appears on the display to remind you that the appliance needs descaling.

To access the descaling menu:

1. Turn the appliance on and wait until it is ready for use;
2. Press / to enter the "Settings" menu;
3. Press the scroll arrows / (B3) or / (B5) until "Maintenance" is displayed, then press / ;
4. Press the scroll arrows / or / until "Descaling" is displayed, then press ;
5. Confirm by pressing / ;
6. (If the filter is installed): extract the water tank (A12), remove the water softener filter (C4) and empty the water tank. Press / ;
7. Pour the descaler into the tank up to level A (corresponding to a 100ml pack) marked on the inner surface of the tank, then add water (one litre) up to level B (fig. 40) and put the water tank back. Press / ;

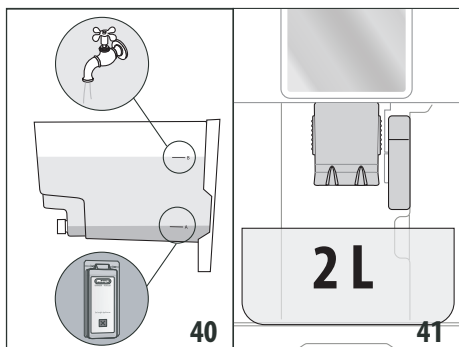

8. Remove, empty and replace the drip tray (A22) and grounds container (A23). Press $\text{OK}/\bullet\bullet$;
9. Place an empty container with a recommended capacity of 2 litres under the hot water spout (E) and coffee spouts (A16) (fig. 41). Press $\text{MY}/\blacktriangleleft$;

Important! Danger of scalding

Hot water containing acid flows out of the coffee spouts and hot water spout. Take care to avoid contact with splashes of this solution.

10. The descale programme starts and the descaler liquid comes out of the hot water and coffee spouts. A series of rinses and pauses is performed automatically to remove all the scale residues inside the coffee machine;

After about 25 minutes, descaling stops;

11. The appliance is now ready for rinsing through with clean water. Empty the container used to collect the descaler solution. Extract the water tank, empty, rinse under running water, fill with fresh water up to the MAX level and put back in the appliance. Press $\text{OK}/\bullet\bullet$;
12. Place the container used to collect the descaler solution empty under the coffee spouts and hot water spout (fig. 41) and press $\text{OK}/\bullet\bullet$;
13. Confirm by pressing $\text{OK}/\bullet\bullet$;
14. Hot water is delivered first from the coffee spouts, then from the hot water spout;
15. When the water in the tank has run out, empty the container used to collect the rinsing water;
16. Extract the water tank and fill with fresh water up to the MAX level. Press $\text{OK}/\bullet\bullet$;
17. (If the filter was installed) Put the water softener filter (if previously removed) back in its housing in the water tank (A13), and replace the tank in the appliance, then press $\text{OK}/\bullet\bullet$;
18. Place the container used to collect the descaler solution empty under the hot water spout. Press $\text{OK}/\bullet\bullet$;
19. "Rinsing Confirm?": press $\text{OK}/\bullet\bullet$;

20. "Rinsing underway". Hot water comes out of the hot water spout;
 21. When descaling is complete, press $\text{OK}/\bullet\bullet$;
 22. "Empty drip tray": At the end of the second rinse, remove, empty and replace the drip tray (A22) and grounds container (A23). Press $\text{OK}/\bullet\bullet$;
 23. Empty the container used to collect the rinse water, remove the water tank and fill with fresh water up to the MAX level, then put back in the appliance.
- The descaling cycle is now complete.

Please note:

- If the descaling cycle is not completed correctly (e.g. no electricity) we recommend repeating the cycle;
- After descaling, it is normal for the grounds container (A23) to contain water;
- If the water tank has not been filled to the MAX level, at the end of descaling, the appliance requests a third rinse to guarantee that the descaler solution has been completely eliminated from the machine's internal circuits. Before starting rinsing, remember to empty the drip tray.

14. SETTING WATER HARDNESS

The descaling request is displayed after a period of time established according to water hardness.

The machine is set by default for a hardness level of 4. The machine can also be programmed according to the hardness of the mains water in the various regions so that the machine needs to be descaled less often.

14.1 Measuring water hardness

1. Remove the "TOTAL HARDNESS TEST" indicator paper (C1) from its pack (attached to the English instructions);
2. Immerse the paper completely in a glass of water for one second;
3. Remove the paper from the water and shake lightly. After about a minute, 1, 2, 3, or 4 red squares form, depending on the hardness of the water. Each square corresponds to 1 level;

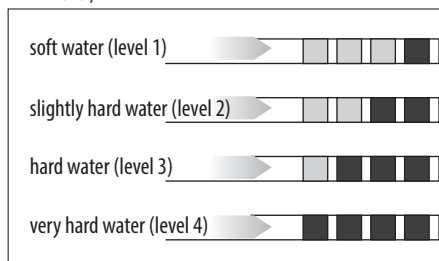

14.2 Setting water hardness

1. Press ESC/ESC (B2) to enter the menu;

2. Press the scroll arrows **my** / ◀ (B3) or ▶ / **my** (B5) until "General" is displayed;
3. Press **ok** / **00** (B4) to confirm;
4. Press the scroll arrows **my** / ◀ or ▶ / **my** until "Water hardness" is displayed;
5. Press **ok** / **00**. The current value appears on the display (D6) and the "New" value flashes;
6. Select the new value you want to set using the scroll arrows **my** / ◀ or ▶ / **my**;;
7. After selecting the quantity, press **ok** / **00**.
The display goes back to the previous screen.
Press **esc** / **esc** twice to go back to the main screen.

15. WATER SOFTENER FILTER

Certain models are fitted with a water softener filter (C4). If this is not the case with your model, you are recommended to purchase one from De'Longhi Customer Services. To use the filter correctly, follow the instructions below.

15.1 Installing the filter

1. Remove the filter (C4) from the packaging. The date indicator disk varies according to the filter provided.
2. Turn the date indicator disk (fig. 42) until the next 2 months of use are displayed.

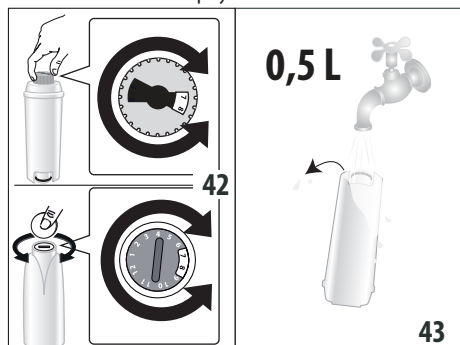

Please note

The filter lasts about two months if the appliance is used normally. If the coffee maker is left unused with the filter installed, it will last a maximum of three weeks.

3. To activate the filter, run tap water through the hole in the filter as shown in fig. 42 until water comes out of the openings at the side for more than a minute;

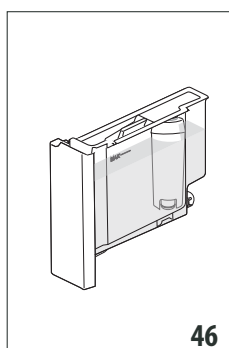
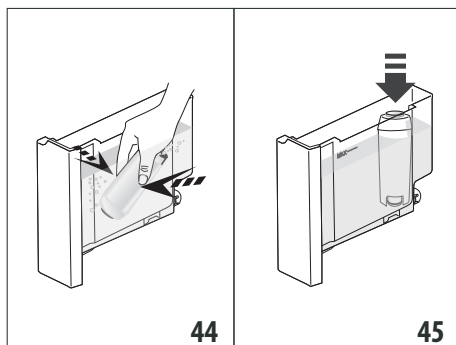

4. Extract the tank (A12) from the appliance and fill with water;
5. Insert the filter in the water tank and immerse it completely for about ten seconds, sloping it and pressing it lightly to enable the air bubbles to escape (fig. 44);
6. Insert the filter in the filter housing (A13) and press fully home (fig. 45);

7. Close the tank with the lid (A11) (fig. 46), then replace the tank in the machine;
8. When you install the filter you must notify the appliance of its presence.
9. Press **esc** / **esc** (B2) to enter the "Settings" menu;
10. Press the scroll arrows **my** / ◀ (B3) or ▶ / **my** (B5) until "Maintenance" is displayed, then press **ok** / **00** (B4);
11. Press the scroll arrows until "Install filter" is displayed, then press **ok** / **00**;
12. Press **ok** / **00** to confirm;
13. Place an empty container with a minimum capacity of 500 ml under the hot water/steam spout (E), then press **ok** / **00** to start delivery;
14. The appliance starts delivering water;
15. After the flow of hot water stops, the appliance automatically reverts to ready for use again.

The filter is now active and you can use the coffee machine.

15.2 Replacing the filter

Replace the filter (C4) when requested by the appliance. To replace immediately, press **ok** / **00** (B4) and follow the instructions from point 8. To replace the filter later, press **esc** / **esc** (B2). The **my** symbol appears on the display to remind you that the filter needs replacing.

To replace, proceed as follows:

1. Extract the tank (A12) and exhausted filter;
2. Take the new filter out of its packet and proceed as illustrated in points 2, 3, 4, 5, 6 and 7 in the previous section;
3. Press /ESC (B2) to enter the "Settings" menu;
4. Press the scroll arrows /my (B3) or /ESC (B5) until "Maintenance" is displayed, then press /OK;
5. Press the scroll arrows until "Replace filter" is displayed, then press /OK;
6. Press /OK to confirm;
7. Place an empty container with a minimum capacity of 500 ml under the hot water/steam spout (E), then press /OK (fig. 8) to start delivery;
8. After the flow of hot water stops, the appliance automatically reverts to ready for use again.

The new filter is now active and the coffee machine can be used.

Please note:

After two months (see date indicator) or when the appliance has not been used for 3 weeks, you should replace the filter even if the message has not yet been displayed.

15.3 Removing the filter

If you want to use the appliance without the filter (C4), you must remove it and notify the appliance of its removal. Proceed as follows:

1. Extract the tank (A12) and exhausted filter;
2. Press /ESC (B2) to enter the "Settings" menu;
3. Press the scroll arrows /my (B3) or /ESC (B5) until "Maintenance" is displayed, then press /OK (B4);

4. Press the scroll arrows /my or /ESC until "Remove filter" is displayed, then press /OK;
5. Press /OK to confirm removal. The appliance goes back to the previous screen;
6. Then press /ESC twice to exit the menu.

Please note:

After two months (see date indicator) or when the appliance has not been used for 3 weeks, you should replace the filter even if the message has not yet been displayed.

16. TECHNICAL DATA









Voltage:	220-240 V~ 50/60 Hz max. 10A
Absorbed power:	1350W
Pressure:	1,5MPa (15 bars)
Max. water tank capacity:	1.4 l
Size LxDxH:	281x425x400 mm
Cord length:	1450 mm
Weight:	11.9 kg
Max. beans container capacity:	250 g



16.1 Tips for Energy Saving

- To reduce energy consumption, remove the milk container (D) or other accessories;
- Set auto-off to 15 minutes (see section "6.4 General");
- Enable Energy Saving (see paragraph "6.4 General");
- When requested by the machine, perform the descaling cycle (see section "13. Descale").

17. DISPLAYED MESSAGES

DISPLAYED MESSAGE	POSSIBLE CAUSE	REMEDY
Fill tank	Insufficient water in the tank (A12).	Fill the tank with water and/or insert it correctly, pushing it as far as it will go until it clicks into place (fig. 5).
	The tank (A12) is not correctly in place.	Insert the tank correctly and press as far as it will go (fig. 5).
Empty grounds container	The grounds container (A23) is full.	Empty the grounds container and drip tray (A22), clean and replace. Important: when removing the drip tray, the grounds container MUST be emptied, even if it contains few grounds. If this is not done, when you make the next coffees, the grounds container may fill up more than expected and clog the machine.
Insert grounds container	After cleaning, the grounds container (A23) has not been replaced.	Remove the drip tray (A22) and insert the grounds container.
		→

DISPLAYED MESSAGE	POSSIBLE CAUSE	REMEDY
Add pre-ground coffee ESC to cancel	The pre-ground coffee function has been selected without placing any pre-ground coffee in the funnel (A4).	Place pre-ground coffee in the funnel or deselect the "pre-ground" function.
Add pre-ground coffee ESC OK	A LONG coffee with pre-ground coffee has been requested	Put one level measure of pre-ground coffee into the pre-ground coffee funnel (A4) and press  /  (B4) to continue and complete preparation.
Fill beans container ESC to cancel	The coffee beans have run out.	Fill the beans container (A4) (fig. 10).
	The pre-ground coffee funnel (A4) is clogged.	Empty the funnel with the help of a brush (C5) as described in section "12.8 Cleaning the pre-ground coffee funnel".
Ground too fine Adjust mill ESC to cancel	The grinding is too fine and the coffee is delivered too slowly or not at all.	Repeat coffee delivery and turn the grinding adjustment dial (A8) (fig. 13) one click clockwise towards "7" while the coffee mill is in operation. If after making at least 2 coffees delivery is still too slow, repeat the correction procedure, turning the grinding adjustment dial another click until delivery is correct (see section "7.4 Adjusting the coffee mill"). If the problem persists, make sure the water tank (A12) is fully inserted.
	If the water softener filter (C4) is present, an air bubble may have been released inside the circuit, obstructing delivery.	Insert the hot water spout (C) in the appliance and deliver a little water until the flow becomes regular.
Less coffee ESC to cancel	Too much coffee has been used.	Select a lighter taste by pressing  /  (B4) or reduce the quantity of pre-ground coffee.
Insert water spout	The water spout (E) is not inserted or is inserted incorrectly.	Fully insert the hot water spout (fig. 6).
Insert milk container	The milk container (D) is not inserted correctly.	Insert the milk container (fig. 19) as far as it will go.
Close door	The service door (A14) is open.	Close the service door.
Insert infuser assembly	The infuser has not been replaced after cleaning.	Insert the infuser as described in section "12.9 Cleaning the infuser".
Water circuit empty Fill water circuit Hot water Confirm?	The water circuit is empty.	Press  /  (B4) and deliver water from the spout (E). If the problem persists, make sure the water tank (A12) is fully inserted.
Press OK to CLEAN	The milk container (D) has been inserted with the froth adjustment dial (D2) in the "CLEAN" position.	To proceed with the CLEAN function press  /  (B4) or turn the froth adjustment dial to another position.
Set dial to CLEAN ESC to cancel	Milk has been delivered recently and the tubes inside the milk container (D) must be cleaned.	Turn the froth adjustment dial (D2) to CLEAN (fig. 20).
→		

DISPLAYED MESSAGE	POSSIBLE CAUSE	REMEDY
Turn the milk froth adjustment dial	The milk container (D) has been inserted with the froth adjustment dial (D2) in the "CLEAN" position.	Turn the froth adjustment dial to one of the milk froth positions.
Descalc ESC to cancel OK to descale (~45 minutes)	The machine must be descaled.	The descaling procedure described in section "13. Descalc" needs to be performed.
Replace filter ESC to cancel OK to replace	The water softener filter (C4) is exhausted.	Replace the filter or remove it as described in section "15. Water softener filter".
General alarm	The inside of the appliance is very dirty.	Clean the inside of the appliance thoroughly, as described in section "12. Cleaning". If the message is still displayed after cleaning, contact a customer service centre.
	The tubes inside the milk container (D) must be cleaned.	Turn the froth adjustment dial (D2) to CLEAN (fig. 20).
	The water softener filter (C4) is exhausted and must be replaced or removed.	Replace the filter or remove it as described in section "15. Water softener filter".
	The machine must be descaled.	The descaling procedure described in section "13. Descalc" needs to be performed. The appliance may request descaling cycles at very short intervals. This is normal and due to the appliance's advanced control system.
ECO	Energy saving is enabled.	To disable energy saving, proceed as described in section "6.4 General" - "Energy saving:"

18. TROUBLESHOOTING

Below is a list of some of the possible malfunctions.

If the problem cannot be resolved as described, contact Customer Services.

PROBLEM	POSSIBLE CAUSE	REMEDY
The coffee is not hot.	The cups were not preheated.	Warm the cups by rinsing them with hot water (Please note: you can use the hot water function).
	The internal circuits of the appliance have cooled down because 2/3 minutes have elapsed since the last coffee was made.	Before making coffee, heat the infuser by performing a rinse cycle (see section "6.1 Rinsing").
	A low coffee temperature is set.	Set a higher coffee temperature in the menu (see section "6.4 General" "Set temperature:")
		→

PROBLEM	POSSIBLE CAUSE	REMEDY
The coffee is weak or not creamy enough.	The coffee is ground too coarsely.	Turn the grinding adjustment dial (A8) one click anticlockwise towards "1" while the coffee mill is in operation (fig. 13). Continue one click at a time until the coffee is made satisfactorily. The effect is only visible after delivering 2 coffees (see section "7.4 Adjusting the coffee mill").
	The coffee is unsuitable.	Use coffee for espresso machines.
The coffee is delivered too slowly or a drop at a time.	The coffee is ground too finely.	Turn the grinding adjustment dial (A8) one click clockwise towards "7" while the coffee mill is in operation (fig. 13). Continue one click at a time until coffee delivery is satisfactory. The effect is only visible after delivering 2 coffees (see section "7.4 Adjusting the coffee mill").
The LONG coffee is too creamy	The coffee is ground too finely.	Turn the grinding adjustment dial "A8. Grinding adjustment dial" one click clockwise towards "7" while the coffee mill is in operation (fig. 13). Continue one click at a time until coffee delivery is satisfactory. The effect is visible only after 2 coffees have been made.
The appliance will not make coffee	The appliance has detected impurities in its internal circuits. "Please wait" is displayed.	Wait for the appliance to be ready again and reselect the required beverage. Contact Customer Services if the problem persists.
Coffee does not come out of one or both of the spouts.	The coffee spouts (A16) are blocked.	Clean the spouts with a toothpick (fig. 26B).
The appliance does not come on	It is not plugged into the mains socket.	Plug into the mains socket (fig. 1).
	The main switch (A9) is not pressed.	Place the main switch in the I position (fig. 2).
The infuser cannot be extracted	The appliance has not been turned off correctly	Turn the appliance off by pressing the  button (A7) (fig. 9) (see section "5. Turning the appliance off").
At the end of descaling, the appliance requests a third rinse	During the two rinse cycles, the water tank (A12) has not been filled to the MAX level.	Follow the instructions displayed by the appliance, but first empty the drip tray (A22) to avoid the water overflowing.
Milk does not flow from the milk spout (D3)	The milk container lid (D1) is dirty	Clean the milk container lid as described in section "12.10 Cleaning the milk container (D)".
	Make sure the milk intake tube (D5) is correctly inserted in the bottom of the milk container lid (fig. 17)	Insert the milk intake tube as far as it will go
→		

PROBLEM	POSSIBLE CAUSE	REMEDY
The milk contains large bubbles and squirts out of the milk spout (D3) or there is little froth	The milk is not cold enough or is not semi-skimmed or skimmed	Use skimmed or semi-skimmed milk at refrigerator temperature (about 5°C). If the result is not as you wished, try changing brand of milk.
	The froth adjustment dial (D2) is incorrectly adjusted.	Adjust following the instructions in section "10.2 Regolare la quantità di schiuma".
	The milk container lid (D1), froth adjustment dial (D2), or milk intake tube (D7) are dirty	Clean the milk container lid, dial and milk intake tube as described in section . "12.10 Cleaning the milk container (D)".
	The hot water connection nozzle (A15) is dirty	Clean the connection nozzle as described in section "12.11 Cleaning the hot water nozzle".
The machine emits noises or small puffs of steam while not in use	The machine is ready for use, or has recently been turned off, and condensate is dripping into the hot vaporiser	This is part of normal operation. To limit the phenomenon, empty the drip tray.