



www.delonghi.com



Instructions for use. Keep these instructions
Mode d'emploi. Conservez cette notice
Instrucciones para el uso. Repase y guarde
estas instrucciones. Lea cuidadosamente este
instructivo antes de usar su aparato

**FULLY AUTOMATIC COFFEE CENTER
MACHINE À CAFÈ AUTOMATIQUE
CAFETERA SUPERAUTOMATICA
ESAM5600**



Register this product on-line and receive a free trial issue of Cook's Illustrated. Visit www.delonghiregistration.com. Visit www.delonghiousa.com for a list of service centers near you. (U.S. and Canada Only)

Registre este producto en línea y reciba un ejemplar gratis de Cook's Illustrated. Visite www.delonghiregistration.com. Visite www.delonghiousa.com para ver la lista de centros de servicios cercanos a usted. (Solamente en los Estados Unidos y Canada)

Enregistrez ce produit en ligne et recevez un numéro gratuit de Cook's Illustrated. Visitez www.delonghiregistration.com. Visitez www.delonghiousa.com pour y voir une liste des centres de réparation proches de chez vous. (É.-U. et Canada uniquement)

Electronic Characteristics: Caractéristiques électriques: Características electricas:
120V ~60 HZ 1 350 W

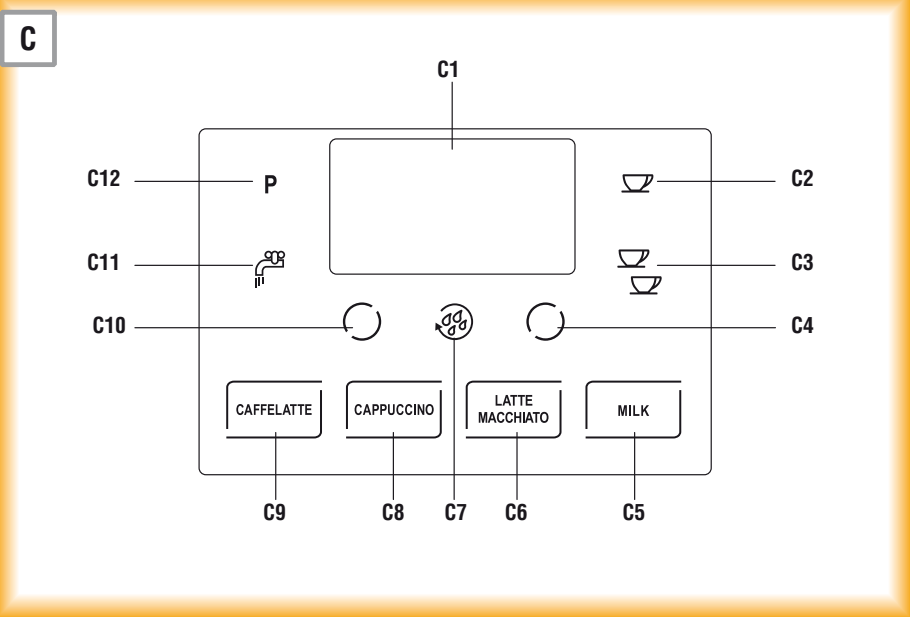
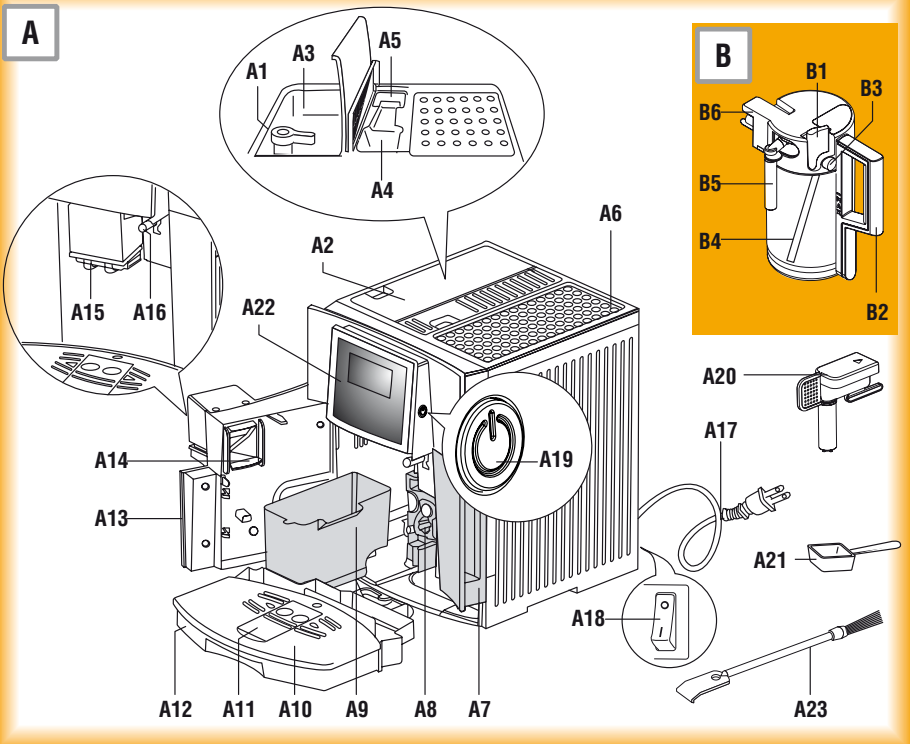

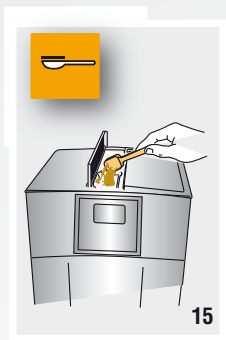
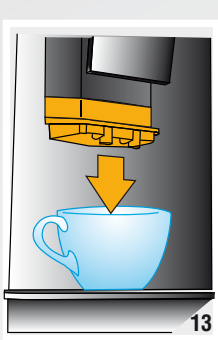
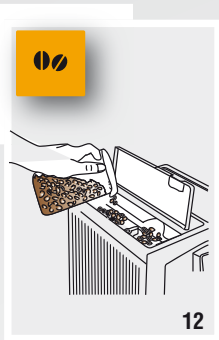
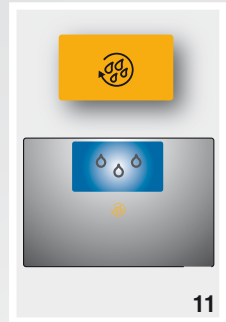
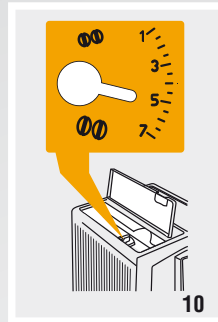
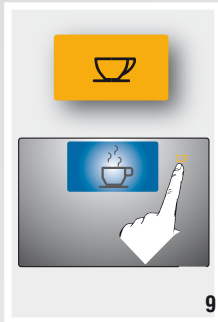
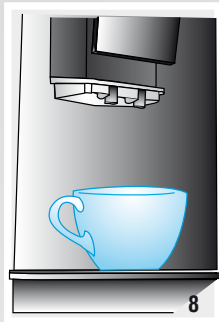
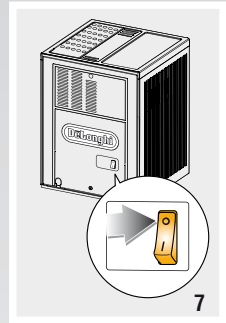
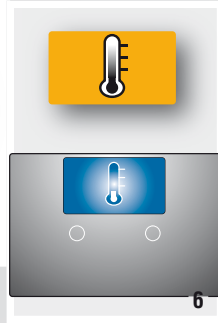
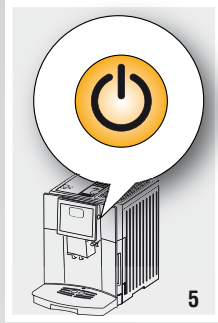
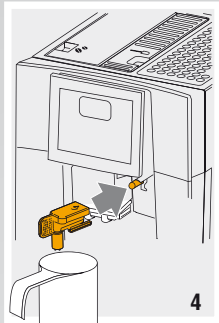
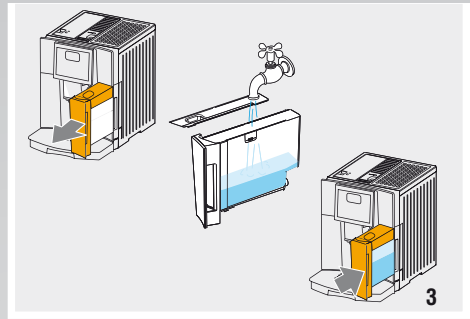
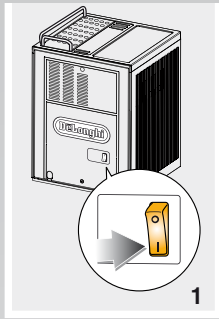

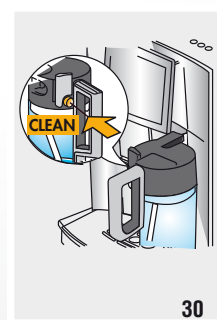
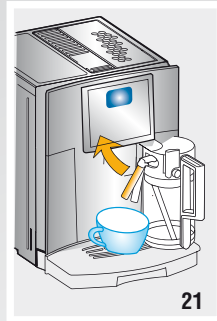
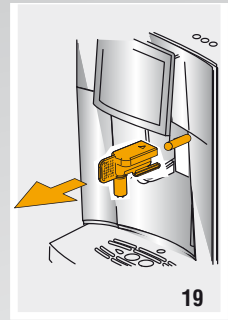
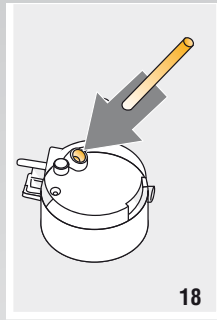
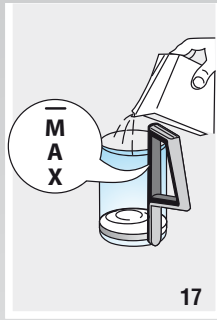

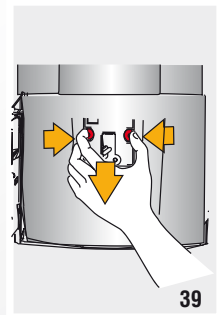
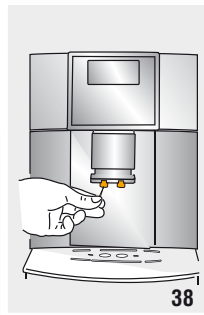
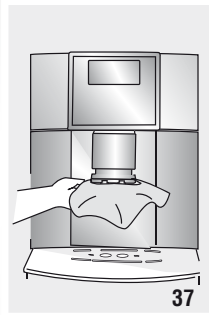
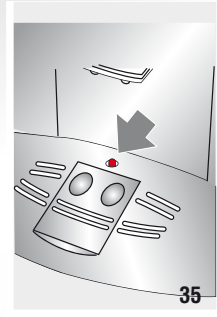
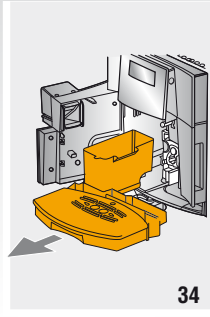
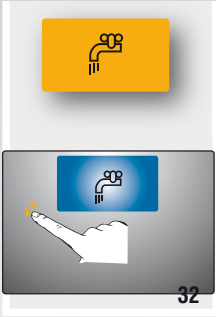

CONTENTS

IMPORTANT SAFEGUARDS	8
SAVE THESE INSTRUCTIONS	8
SHORT CORD INSTRUCTIONS.....	8
INTRODUCTION	9
Symbols used in these instructions	9
Letters in brackets	9
Troubleshooting and repairs	9
DESCRIPTION	9
Description of the appliance	9
Description of milk container	9
Description of graphic touch screen	9
Meaning of animations	10
PRELIMINARY CHECKS	10
Checking the appliance	10
Connecting the appliance	10
Using the appliance for the first time	10
TURNING THE APPLIANCE ON	11
TURNING THE APPLIANCE OFF	11
MENU SETTINGS	11
Setting the language	11
Energy Saving	12
Coffee temperature	12
Beep	12
Default values (reset)	12
Descaling	12
Statistics function	12
Adjust time	13
Auto-Start	13
Auto-Off (Stand-by)	13
MAKING COFFEE	13
Selecting the coffee taste	13
Selecting the quantity of coffee in the cup	13
"Quantity" bar	14
Coffee selected	14
Customising the "my coffee" quantity	14
Regulating the coffee mill	14
Tips for a hotter coffee:	14
Preparing coffee using coffee beans	14
Making coffee using pre-ground coffee	15
MAKING DRINKS WITH MILK.....	15
Filling and attaching the milk container	15
Making cafelatte	15
Making cappuccino	15
Making macchiato	16
Making milk	16
Cleaning the milk container after use	16
Programming the quantities of coffee and milk in the cup	16
HEATING WATER	16
Preparation	16
Changing the quantity	17
CLEANING	17
Cleaning the coffee maker	17
Cleaning the coffee grounds container	17
Cleaning the drip tray	17
Cleaning the inside of the machine	17
Cleaning the water tank	18
Cleaning the coffee spouts	18
Cleaning the pre-ground coffee funnel	18
Cleaning the infuser	18
Cleaning the milk container	18
Cleaning the graphic touch screen	18
DESCALING.....	19
SETTING WATER HARDNESS.....	19
Measuring water hardness	19
Set water hardness	19
TECHNICAL SPECIFICATION.....	20
DISPLAYED MESSAGES	21
TROUBLESHOOTING	22
LIMITED WARRANTY	24

IMPORTANT SAFEGUARDS

When using electrical appliances, basic safety precautions should always be followed, including the following.

- Read all instructions carefully.
- Make sure the voltage of your electrical system corresponds to the voltage shown on the bottom of the machine.
- Do not touch hot surfaces. Use handles or knobs.
- To protect against fire, electrical shock and personal injury, do not immerse cord, plug or appliance in water or other liquid.
- Keep the appliance out of the reach of children and do not leave appliance unattended while in operation.
- Unplug from the outlet when not in use and before cleaning.
- Do not operate with a damaged cord or plug, or after the appliance malfunctions, or has been damaged in any manner. Return the appliance to the nearest authorized service facility for examination, repair or adjustment.
- The use of accessory attachments not recommended by the manufacturer may result in fire, electrical shock, or personal injury.
- Do not use outdoors.
- Make sure the power cord does not hang over the edge of the table or counter-top to avoid getting accidentally caught or entangled.
- Do not place the appliance or its electrical parts on or near electric stoves, cooking surfaces, or gas burners.
- Plug cord into the wall outlet. To disconnect, first turn machine "off", then remove plug from wall outlet.
- Do not use the appliance for other than the intended use. This appliance is to be utilized for domestic use only. The manufacturer declines all responsibility for any damage caused by improper, incorrect, or irresponsible use.

WARNING: To reduce the risk of fire or electric shock, do not remove the cover or the exterior of the unit. Don't attempt to repair or modify the machine, doing so will void the warranty. Repair should be done by authorized service personnel only!

SAVE THESE INSTRUCTIONS

THIS APPLIANCE IS FOR HOUSEHOLD USE ONLY

SHORT CORD INSTRUCTIONS

A short power cord is provided to reduce risks resulting from becoming entangled in or tripping over a longer cord.

- Longer, detachable power supply cords or extension cords are available and may be used if care is exercised in their use.
- If an extension cord is used, the marked electrical rating should be at least as great as the electrical rating of the appliance. If the appliance is provided with 3- wire, grounding type cord, the extension should be a GROUNDING TYPE 3 - WIRE CORD. The longer cord should be arranged so that it will not drape over the counter-top or table top where it can be pulled on by children or tripped over.
- Your product is equipped with a polarized alternating current line plug (a plug having one blade wider than the other). This plug will fit into the power outlet only one way. This is a safety feature. If you are unable to insert the plug fully into the outlet, try reversing the plug. If the plug should still fail to fit, contact your electrician to replace your obsolete outlet. Do not defeat the safety purpose of the polarized plug.

INTRODUCTION

Thank you for choosing this coffee machine. To get the very best out of your new coffee machine it is advisable to read these instructions before using the appliance. This is the only way to ensure optimum results and maximum safety. The manufacturer is not liable for damage deriving from the failure to comply with the user instructions.

Symbols used in these instructions

Important warnings are identified by these symbols. These warnings must absolutely be respected.



Danger!

Failure to observe the warning could result in possibly life threatening injury from electric shock.



Important!

Failure to observe the warning could result in injury or damage to the appliance.



Danger of burns!

Failure to observe the warning could result in scalds or burns.



Please Note :

This symbol identifies important advice or information for the user.

Letters in brackets

The letters in brackets refer to the legend in the Description of the appliance on page 9.

Troubleshooting and repairs

In the event of problems, first try and resolve them following the information given in the sections "Displayed messages" on page 21 and "Troubleshooting" on page 22

If this does not resolve the problem or you require further information, you should consult Customer Services. Please see enclosed guarantee leaflet.

If repairs are required, contact De'Longhi Customer Services only.

The addresses are given in the guarantee certificate provided with the appliance.

DESCRIPTION

Description of the appliance

(page 3 - **A**)

- A1. Grinding adjustment dial
- A2. Beans container lid
- A3. Beans container
- A4. Pre-ground coffee funnel
- A5. Measure compartment
- A6. Cup shelf (cup warmer active when Energy Saving is disabled)
- A7. Water tank
- A8. Infuser
- A9. Grounds container
- A10. Cup tray
- A11. Compartment for macchiato/milk glass
- A12. Drip tray
- A13. Service door
- A14. Coffee guide
- A15. Coffee spout (adjustable height)
- A16. Hot water and steam nozzle
- A17. Power cable
- A18. Main switch
- A19. ON/STAND-BY button
- A20. Hot water spout
- A21. Measure
- A22. Graphic touch screen
- A23. Cleaning brush

Description of milk container



(page 3 - **B**)

- B1. Froth regulator
- B2. Milk container handle
- B3. CLEAN button
- B4. Milk intake tube
- B5. Frothed milk spout
- B6. Lid with milk frother



Description of graphic touch screen

(page 3 - **C**)

Only the icons relating to the controls enabled for the particular function currently being used will be lit on the touch screen.

- C1. Display: guides the user in using the appliance.
- C2.  icon: to deliver one cup of coffee.
- C3.  icon: to deliver two cups of coffee.
- C4. Selection icons to choose the coffee taste. (*When in the settings MENU, they change function according to the text shown above the icon*).
- C5. **MILK** icon: to deliver a cup of milk.
- C6. **LATTE MACCHIATO** icon: to deliver a cup of macchiato.
- C7.  icon to perform a manual rinse.

(When in the settings MENU, they change function according to the text shown above the icon).

- C8. **CAPPUCCINO** icon: to deliver a cappuccino.
- C9. **CAFFELATTE** icon: to deliver a caffelatte.
- C10. Selection icon to choose the coffee quantity.
(When in the settings MENU, it changes function according to the text shown above the icon).
- C11.  icon: to activate the hot water function.
- C12.  icon: to access or exit the settings menu.



Please Note :

A light touch is enough to activate the icon.

Meaning of animations

Below is an explanation of the animations describing the operation the appliance is currently performing:



RINSING.



HEATING UP.



IMPORTANT MESSAGE
(see section: "Displayed messages").



PLEASE WAIT...



FILL TANK!



HOT WATER

PRELIMINARY CHECKS

Checking the appliance

After removing the packaging, make sure the product is complete and undamaged and that all accessories are present. Do not use the appliance if it is visibly damaged. Contact De'Longhi Customer Services. Please see enclosed guarantee leaflet.

Installing the appliance



Important!

When you install the appliance, you should respect the following safety warnings:

- The appliance gives off heat. After positioning the appliance on the worktop, leave a space of at least 3 cm between the surfaces of the appliance and the side and rear walls and at least 15 cm above the coffee maker.
- Water penetrating the appliance could cause damage. Do not place the appliance near water faucets or sinks.
- The appliance could be damaged if the water it contains freezes. Do not install the appliance in a room where the temperature could drop below freezing point.
- Arrange the power cable in such a way that it cannot be damaged by sharp edges or contact with hot surfaces (e.g. electric hot plates).

Connecting the appliance



Important!

Check that the mains power supply voltage corresponds to the value indicated on the rating plate on the bottom of the appliance.

Connect the appliance to an efficiently earthed and correctly installed socket with a minimum current rating of 10A only.

If the power socket does not match the plug on the appliance, have the socket replaced with a suitable type by a qualified professional.

Using the appliance for the first time



Please Note :

- Coffee has been used to factory test the appliance and it is, therefore, completely normal for there to be traces of coffee in the mill. The machine is, however, guaranteed to be new.
- You should customize water hardness as soon as possible following the instructions in the section "Setting water hardness" on page 19.

1. Plug the appliance into the mains socket and place the main switch on the back of the appliance in the I position (fig. 1).

You must first choose the language on the display (the languages scroll through at intervals of about 3 seconds).

2. When English appears, press the selection icon corresponding to OK on the display for a few seconds (fig. 2). Once the language has been saved, the message "English installed" is displayed.

Follow the instructions indicated by the appliance:

3. "FILL TANK!": remove the water tank, fill to the MAX line with fresh water then replace in the appliance (fig. 3).
4. "INSERT WATER SPOUT!": Check that the hot water spout is inserted on the nozzle and place a container with a minimum capacity of 100 ml underneath (fig. 4).

5. "Press OK": then press the icon corresponding to OK on the display (fig. 2). "Please wait..." is displayed and the appliance begins to deliver water from the hot water spout.

The appliance ends the first start up procedure and goes off. The coffee maker is now ready for normal use.

i Please Note:

- When using the appliance for the first time, you need to make 4/5 cups of coffee or 4/5 cappuccinos before the appliance starts to give satisfactory results.

TURNING THE APPLIANCE ON

i Please Note:

Before turning the appliance on, make sure the main switch on the back of the appliance is in the I position (fig. 1).

Each time the appliance is turned on, it performs an automatic preheat and rinse cycle which cannot be interrupted.

A drop animation indicates that rinsing is underway (see section "Meaning of animations").

The appliance is ready for use only after completion of this cycle.

SSS Danger of burns!

During rinsing, a little hot water comes out of the coffee spouts and is collected in the drip tray underneath.

Avoid contact with splashes of water.

- To turn the appliance on, press the  button (fig. 5). The appliance begins the heating cycle indicated by a thermometer icon (fig. 6) which fills as the cycle advances. During heating, the machine performs an automatic rinse cycle: as well as heating the boiler, the appliance also heats the internal circuits by circulating hot water.

Once heating is complete, the appliance shows the time and the coffee taste and quantity selection bars set to the standard values ("standard" quantity and taste). The coffee maker is now ready for use.

TURNING THE APPLIANCE OFF

Each time the appliance is turned off, it performs an automatic rinse cycle which cannot be interrupted.

! Important!

To avoid damaging the appliance, always press the  (fig. 5) button to turn off.

SSS Danger of burns!

During rinsing, a little hot water flows from the coffee spouts. Avoid contact with splashes of water.

To turn the appliance off, press the  button (fig. 5). The appliance performs the rinse cycle then goes off.

i Please Note:

If the appliance is not used for an extended period, place the main switch in the 0 position (fig. 7).

! Important!

Never place the main switch in the 0 position while the appliance is on.

MENU SETTINGS

The settings menu is divided into 3 sections indicated by different icons. Each section is divided into groups as described below:

SETTINGS

- Language
- Energy Saving
- Coffee temperature
- Water hardness
- Display contrast
- Beep
- Default values



MAINTENANCE

- Descaling
- Statistics



CLOCK

- Adjust time
- Auto-Start
- Auto-Off (Stand-by)



To access the required section, press the **P** icon and use the selection icons (C4 and C10) to scroll until the image you want is displayed. Then press the  icon to confirm (or the **P** icon again to exit).



i Please Note!

When navigating in the settings menu and you want to exit, press the **P** icon a number of times.

Setting the language



To modify the language on the display, proceed as follows:

1. Choose the "SETTINGS" section as described above;
2. Press the selection icons < or > until "Language" is displayed;

3. Press the  icon to confirm;
 4. Press the selection icons < or > until the required language is displayed;
 5. Press the  icon to confirm;
- The language is set. Press the **P** icon a number of items to exit the menu.

Energy Saving

Use this function to enable or disable energy saving mode. When enabled, the function reduces energy consumption in compliance with European regulations.

1. Choose the "SETTINGS" section as described above;
2. Press the selection icons < or > until "Energy saving" is displayed;
3. Press the  icon to confirm. "Disable?" is displayed (or "Enable?" if the function has already been disabled).
4. Press the  icon to disable or enable the function.
5. Press the **P** icon a number of times to exit the menu.



When the function is enabled, if the appliance is not used for about 1 minute, "Energy Saving" is displayed.

 Please note:

- A few seconds may elapse between "Energy Saving" mode and delivery of the first drink. This is indicated by the rapid increase then decrease of the progress bar and display of the message "Preparation underway".
- When "Energy Saving" is disabled, the appliance turns the cup warmer on automatically.

Coffee temperature

To modify the temperature of the water used to make the coffee, proceed as follows:

1. Choose the "SETTINGS" section as described above;
2. Press the < or > until "Coffee temperature" is displayed;
3. Press the  icon to confirm.
4. Press the < or > icon until "Coffee temperature" is displayed (● = low; ●●●● = high);
5. Press the  icon to confirm.
6. Press the **P** icon a number of times to exit the menu.

Setting water hardness

For instructions on setting water hardness, see page 19.

Setting display contrast

To increase or reduce the contrast of the display, proceed as follows:



1. Choose the "SETTINGS" section as described above;
2. Press the selection icons < or > until "Display contrast" is displayed;
3. Press the  icon to confirm;
4. Press the selection icons < or > until the required display

contrast is reached. The progressive bar indicates the level of contrast selected.

5. Then press the  icon to confirm or the **P** icon to exit the menu;
6. Press the **P** icon a number of times to exit the menu.



Beep

This enables or disables the beep emitted by the machine each time an icon is pressed or an accessory is inserted/removed. The beep is active by default.

1. Choose the "SETTINGS" section as described above;
2. Press the selection icons < or > until "Beep" is displayed;
3. Press the  icon to confirm; "Disable?" is displayed (or "Enable?" if the function is already disabled);
4. Press the  icon to confirm and enable or disable the function.
5. Press the **P** icon a number of times to exit the menu.

Default values (reset)

This resets all menu settings and programmed quantities back to the default values (with the exception of the language which remains as set).

1. Choose the "SETTINGS" section as described above;
2. Press the selection icons < or > until "Default Values" is displayed;
3. Press the  icon to confirm. "OK to confirm" is displayed.
4. Press the  icon to return to the original settings (or the **P** icon to cancel the operation).

The appliance is automatically ready for use again with the default settings.



Descaling

For instructions on descaling, see page 19.

Statistics function

This displays statistics relating to the machine.

To display, proceed as follows:

1. Choose the "MAINTENANCE" section as described above.
2. Press the selection icons < or > until "Statistics" is displayed.
3. Press the  icon to confirm;
4. Press the selection icons < or > to verify:
 - how many coffees have been made;
 - how many drinks with milk have been made;
 - how many times the machine has been descaled.
 - the total number of litres of water delivered.
5. Press the  icon to confirm or the **P** icon to exit the menu.



Adjust time

To adjust the time on the display, proceed as follows:

1. Choose the "CLOCK" section as described above.
2. Press the selection icons < or > until "Adjust time" is displayed.
3. Press the icon to confirm: the hours flash on the display;
4. Press the selection icons < or > to modify the hours.
5. Press the icon to confirm. The minutes flash on the display;
6. Press the selection icons < or > to modify the minutes.
7. Press the icon to confirm (or the **P** icon to cancel the operation).

The time has been set. Press the **P** icon a number of times to exit the menu.



Auto-Start

You can set the auto-start time in order to have the appliance ready at a certain time (for example in the morning) so you can make coffee immediately.



Please Note!

To enable this function, **the time must already be set correctly** (adjust time).

1. Choose the "CLOCK" section as described above.
2. Press the selection icons < or > until "Auto-Start" is displayed.
3. Press the icon to confirm. "Enable?" is displayed (or "Disable?" if the function is already enabled).
4. Press the icon to confirm. The hours flash on the display;
5. Press the selection icons < or > to modify the hours.
6. Press the icon to confirm. The minutes flash on the display;
7. Press the selection icons < or > to modify the minutes;
8. Press the icon to confirm. "Auto-Start enabled" is displayed.
9. Press the **P** icon a number of times to exit the menu. The symbol appears next to the clock to indicate that auto-start has been programmed.

To disable the function:

1. Choose the "Clock" section as described above.
 2. Press the selection icons < or > until "Auto-Start" is displayed.
 3. Press the icon to confirm. "Disable?" is displayed.
 4. Press the icon to confirm. This disables the function and the symbol disappears from the display.
 5. Press the **P** icon a number of times to exit the menu.
- To change the auto-start time when the function is already

enabled:

1. Choose the "CLOCK" section as described above.
2. Press the selection icons < or > until "Auto-Start" is displayed.
3. Press the icon to confirm; "Disable?" is displayed.
4. Press the selection icons < or > until "Adjust time" is displayed.
5. Adjust the time as described above.



Auto-Off (Stand-by)

The appliance is set by default to go off if not used for two hours.

The time can be changed so that the appliance switches off after 15 or 30 minutes, or after 1, 2 or 3 hours.

1. Choose the "CLOCK" section as described above.
2. Press the selection icons < or > icons until "Auto-Off" is displayed.
3. Press the icon to confirm;
4. Press the selection icons < or > until the required number of hours operation (15 or 30 minutes, or 1, 2 or 3 hours) is displayed.
5. Press the icon to confirm (or the **P** icon to cancel the operation).

Auto-Off is programmed. Press the **P** icon a number of times to exit the menu.

MAKING COFFEE

Selecting the coffee taste

The appliance is set by default to make coffee with a standard taste.

To change the taste, press the selection icon (C4) until the "taste" bar has filled as follows:

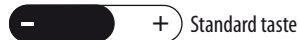
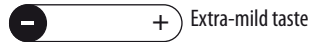

The bar fills up progressively each time you press the selection icon.

Selecting the quantity of coffee in the cup

The appliance is set by default to make a standard quantity of coffee.

To choose the quantity of coffee, press the selection icon (C10) until the "quantity" bar has filled as follows:

"Quantity" bar	Coffee selected	Quantity (fl. oz.)
	MY COFFEE	Program from ≈ 0.68 to ≈ 6.1
	EXTRA SHORT COFFEE	≈ 1
	SHORT COFFEE	≈ 1.35
	STANDARD COFFEE	≈ 2.35
	LONG COFFEE	≈ 3.04
	EXTRA LONG COFFEE	≈ 4.06

The quantity bar fills up progressively each time you press the selection icon.

Customizing the "my coffee" quantity

The appliance is set by default to automatically deliver 30 ml of "my coffee".

To modify these settings, proceed as follows:

- Place a cup under the coffee spouts (fig. 8).
- Press the selection icon (C10) repeatedly until the bar on the display corresponds to the "MY COFFEE"
- Press the (fig. 9) until "MY COFFEE Program Quantity" and the symbol are displayed, then release. The appliance starts delivering coffee and the icon flashes;
- As soon as the coffee in the cup reaches the required level, press the icon again.

The quantity set has now been programmed.

Regulating the coffee mill

The coffee mill is set by default to prepare coffee correctly and should not require regulating initially. However, if after making the first few coffees you find that delivery is either too fast or too slow (a drop at a time), this can be corrected by adjusting the grinding adjustment dial (fig. 10).



Please Note!

The grinding adjustment dial must only be turned when the coffee mill is in operation.

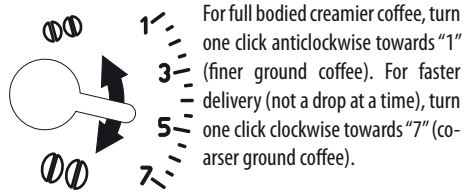

These adjustments will only be evident after at least 2 cups of coffee have been delivered. If delivery is still too fast or too slow, repeat the correction, turning the dial another click.

Tips for a hotter coffee:

For a hotter coffee, you are recommended to:

- perform a rinse cycle before delivering the coffee: press the to select the "Rinsing..." function. Hot water is delivered from the spout, heating the internal circuits and making the coffee delivered hotter;
- if "Energy Saving" mode is disabled, place the cups on the cup warmer until they are warm;
- warm the cups by rinsing them with hot water (using the hot water function);
- in the menu, set coffee temperature to "high" ().

Preparing coffee using coffee beans



Important!

Do not use caramelized or candied coffee beans as they could stick to the coffee mill and make it unusable.

- Fill the container with coffee beans (fig. 12).
- Place under the coffee spouts:
 - 1 cup, if you want 1 coffee (fig. 8);
 - 2 cups, if you want 2 coffees;
- Lower the spouts as near as possible to the cup. This makes a creamier coffee (fig. 13).
- Press the icon corresponding to the number of coffees required (1 cup or 2 cups) (fig. 9 and 14).
- Preparation begins. One or two cups appear on the display and gradually fill as preparation progresses.

Once the coffee has been made, the appliance prepares for use again.



Please Note:

- While the machine is making coffee, delivery can be interrupted at any moment by pressing the icon selected previously.
- At the end of delivery, to increase the quantity of coffee in the cup, just press (within 3 seconds) the icon selected previously.

- For hotter coffee, see the section “Tips for a hotter coffee”.



Important!

If the coffee is delivered a drop at a time, too fast and not creamy enough or too cold, read the tips in the “Troubleshooting” section on page 22.

Various alarm messages could be displayed while the machine is in use. Their meaning is explained in the section “Displayed messages” (page 21).

Making coffee using pre-ground coffee



Important!



- Never add pre-ground coffee when the machine is off or it could spread through the inside of the machine and dirty it. This could damage the appliance.
- Never use more than one level measure or it could dirty the inside of the machine or block the funnel.



Please Note!

If you use pre-ground coffee, you can only make one cup of coffee at a time.



1. Repeatedly press the selection icon (C4) corresponding to the “taste” bar until “Ground” and  flash on the display.
2. Put one level measure of pre-ground coffee into the funnel (fig. 15).
3. Place a cup under the coffee spouts (fig. 8).
4. Press the 1 cup coffee icon  (fig. 9).
5. Preparation begins. A cup appears on the display and gradually fills as preparation progresses.

Once the coffee has been made, the appliance prepares for use again.

MAKING DRINKS WITH MILK



Please Note!

If “Energy Saving” mode is enabled, you may have to wait a few seconds before the drink is delivered.

Filling and attaching the milk container

1. Turn the lid of the milk container clockwise until it becomes noticeably difficult to turn, then remove the lid (fig. 16).
2. Fill the milk container with a sufficient quantity of milk, not exceeding the MAX level marked on the handle (fig. 17).



Please Note!

For a richer denser froth, use skim or 2% milk at refrigerator temperature (about 41°F / 5°C).

To avoid milk with poor froth or large bubbles, always clean the milk lid and hot water nozzle as described in the section “Cleaning the milk container” on page 16 and 18.

3. Make sure the milk intake tube is correctly inserted in the bottom of the milk container lid (fig. 18).
4. Replace the milk container lid and turn anticlockwise as far as it will go.
5. Remove the hot water spout from the nozzle (fig. 19).
6. Attach the container to the nozzle and push as far as it will go (fig. 20). The machine emits a beep (if the beep function is enabled).
7. Place a sufficiently large cup under the coffee spouts and frothed milk spout (fig. 21). To use particularly tall cups/glasses, raise the lid of the special compartment in the cup tray (fig. 22).
8. Follow the instructions below for each function.

Making caffelatte

1. After attaching the milk container (see previous section), position the froth regulator on **CAFFELATTE** (fig. 23) printed on the milk container lid.
2. Press the **CAFFELATTE** icon (fig. 24).
A cup is displayed and gradually fills as preparation progresses. After a few seconds, frothed milk is delivered from the milk spout into the cup below. Milk delivery stops automatically and coffee delivery begins.
3. At the end of delivery, the machine is automatically ready for use again.



Please Note!

If during delivery you want to stop preparing milk, press the **CAFFELATTE** icon or interrupt preparation of the coffee by pressing the  icon.

Making cappuccino

1. After attaching the milk container (see previous section), position the froth regulator on **CAPPUCCINO** printed on the milk container lid (fig. 25).
The quality of froth can be adjusted during delivery by moving the regulator slightly towards **LATTE MACCHIATO** for a denser froth.
2. Press the **CAPPUCCINO** icon (fig. 26). A cup is displayed and gradually fills as preparation progresses. After a few seconds, frothed milk flows out of the milk spout into the cup below. Milk delivery stops automatically and coffee delivery begins.

 *Please Note!*

If during delivery you want to stop preparing milk, press the **CAPPUCCINO** icon or interrupt preparation of the coffee by pressing the  icon.

Making macchiato

1. After attaching the milk container (see previous section), position the froth regulator on LATTE MACCHIATO (fig. 27) printed on the milk container lid.
2. Press the LATTE MACCHIATO icon (fig. 28). A glass is displayed and gradually fills as preparation progresses. After a few seconds, frothed milk flows out of the milk spout into the glass below. Milk delivery stops automatically and coffee delivery begins.
3. At the end of delivery, the machine is automatically ready for use again.

 *Please Note!*

If during delivery you want to stop preparing milk, press the LATTE MACCHIATO icon or interrupt preparation of the coffee by pressing the  icon.

Making milk

1. After attaching the milk container (See section: "Filling and attaching the milk container"), position the froth regulator according to the quantity of froth you require (pos. 3 caffelatte = little froth; pos. 1 cappuccino = abundant froth).
2. Press the MILK icon (fig. 29). A glass is displayed and gradually fills as preparation progresses. After a few seconds, frothed milk is delivered from the milk spout into the cup below.
3. After delivery, the machine is automatically ready for use again.

 *Please Note!*

If during delivery you want to stop preparing milk, press the **MILK** icon once.

Cleaning the milk container after use

 *Important! Danger of burns*

When cleaning the internal tubes of the milk container, a little hot water leaks out of the frothed milk tube (B5). Avoid contact with splashes of water.

When "Press CLEAN button" flashes on the display (each time you use a milk function):

1. Leave the milk container in the machine (you do not need to empty it);
2. Place a cup or other recipient under the frothed milk spout

(fig. 21).

3. Press the CLEAN button (fig. 30) and keep pressing until the progress bar which appears on the display together with the message "Cleaning..." is complete.
4. Remove the milk container and always clean the nozzle with a sponge (fig. 31).





 *Please Note!*

- When "Press CLEAN button" flashes on the display, you can still prepare any type of coffee or milk. If you have to make a number of drinks with milk, wait until you have delivered the last cup before cleaning the container.
- The milk left in the container can be kept in the refrigerator.
- In some cases, to clean you must wait for the appliance to heat up, holding the CLEAN button down.

Programming the quantities of coffee and milk in the cup

The appliance is set by default to automatically deliver standard quantities.

To change these quantities, proceed as follows:

1. Place a cup/glass under the coffee spouts and milk spout (fig. 21).
2. Press the icon corresponding to the function you want to program until "Program Quantity Milk For..." is displayed together with the  or  icon according to the function selected.
3. Release the icon. The appliance starts delivering milk.
4. When the required quantity of milk has been delivered into the cup, press the icon again.
5. After a few seconds, the appliance starts delivering coffee into the cup and the message "Coffee for... Program quantity" is displayed (with the exception of the MILK function) and the  icon flashes.
6. As soon as the coffee in the cup reaches the required level, press the  icon. Coffee delivery stops.

The machine is now reprogrammed with the new quantities.

HEATING WATER

Preparation



 *Important! Danger of burns.*

Never leave the machine unsupervised while delivering hot water.

The hot water spout becomes hot while water is delivering and must be handled by the handle only.

1. Make sure the hot water spout is attached correctly (fig. 4).
2. Place a container under the spout (as close as possible to

avoid splashes).

3. Press the  icon (fig. 32). Preparation begins. "Hot Water" and the corresponding animation are displayed.
4. Water flows out of the spout. Delivery stops automatically after 250 ml / 0.25 liters.
5. To interrupt delivery of hot water manually, press the  icon again.





Please Note!

- If energy saving has been enabled, delivery could be delayed a few seconds.

Changing the quantity

The appliance is set by default to automatically deliver about 250ml / 0.25 liters.. To modify these quantities, proceed as follows:

1. Position a container under the spouts.
2. Press the  icon (the appliance starts delivering hot water) until the message "Hot Water Program Quantity" is displayed and the  icon flashes, then release.
3. When the hot water in the cup reaches the required level, press the  icon again.

The machine is now reprogrammed with the new quantities.

CLEANING

Cleaning the coffee maker

The following parts of the machine must be cleaned regularly:

- coffee grounds container (A9),
- drip tray (A12),
- inside the machine, accessible after opening the service door (A13),
- water tank (A7),
- coffee spouts (A15) and hot water nozzle (A16),
- pre-ground coffee funnel (A4),
- infuser (A8),
- milk container (B)
- touch screen (C)



Important!

- Do not use solvents, abrasive detergents or alcohol to clean the coffee maker. With De'Longhi superautomatic coffee makers, you need not use chemical products to clean the machine.
- None of the components of the appliance can be washed in a dishwasher with the exception of the milk container (B).
- Do not use metal objects to remove encrustations or coffee deposits as they could scratch metal or plastic surfaces.

Cleaning the coffee grounds container

When "EMPTY GROUNDS CONTAINER" is displayed, the grounds container must be emptied and cleaned.

Until the grounds container has been cleaned, the appliance continues to display the message and coffee cannot be made. Even if not full, the empty grounds container message is displayed 72 hours after the last coffee has been prepared. For the 72 hours to be calculated correctly, the machine must never be turned off with the main switch in the 0 position.

To clean (with the machine on):

- Open the service door on the front of the appliance (fig. 33), extract the drip tray (fig. 34), empty and clean.
- Empty the grounds container and clean thoroughly to remove all residues left on the bottom. This can be done with the spatula on the brush (A23) provided.



Important!

When removing the drip tray, the grounds container must be emptied, even if it contains few grounds.

If this is not done, when you make the next coffees, the grounds container may fill up more than expected and clog the machine.

Cleaning the drip tray



Important!

If the drip tray is not emptied regularly, the water could overflow from the edge and seep inside or around the machine.

This could damage the machine, the surface it rests on or the surrounding area.

The drip tray is fitted with a level indicator (red) showing the level of water it contains (fig. 35).

Before the indicator protrudes from the cup tray, the drip tray must be emptied and cleaned.

To remove the drip tray:

1. Open the service door (fig. 33);
2. Remove the drip tray and the grounds container (fig. 34);
3. Empty the drip tray and grounds container (A9) and wash them;
4. Replace the drip tray complete with grounds container;
5. Close the service door.

Cleaning the inside of the machine



Danger of electric shock!

Before cleaning internal parts, the machine must be turned off (see "Turning off") and unplugged from the mains power supply. Never immerse the coffee maker in water.

1. Check regularly (about every 100 coffees) that the inside

of the appliance (accessible after removing the drip tray) is not dirty. If necessary, remove coffee deposits with the brush provided and a sponge.

2. Remove the residues with a vacuum cleaner (fig. 36).

Cleaning the water tank

1. Clean the water tank (A13) regularly (about once a month) with a damp cloth and a little mild washing up liquid.
2. After cleaning the water tank rinse it thoroughly to remove all washing up liquid residues.

Cleaning the coffee spouts

1. Clean the coffee spouts with a sponge or cloth (fig. 37).
2. Check the holes in the coffee spout are not blocked. If necessary, remove coffee deposits with a toothpick (fig. 38).

Cleaning the pre-ground coffee funnel

Check regularly (about once a month) that the pre-ground coffee funnel is not blocked. If necessary, remove coffee deposits with the brush provided (A23).

Cleaning the infuser

The infuser (A8) must be cleaned at least once a month.



Important!

The infuser may not be extracted when the machine is on.

1. Make sure the machine is correctly turned off (see section: "Turning off").
2. Open the service door (fig. 33).
3. Remove the drip tray and grounds container (fig. 34).
4. Press the two red release buttons inwards and at the same time pull the infuser outwards (fig. 39).



Important!

RINSE WITH WATER ONLY

NO DISH SOAP - NO DISH WASHER

Do not use dish soap to clean the infuser as it could cause damage.

5. Soak the infuser in water for about 5 minutes, then rinse under the tap.
6. After cleaning, replace the infuser by sliding it onto the internal support and pin at the bottom, then push the PUSH symbol fully in until it clicks into place.

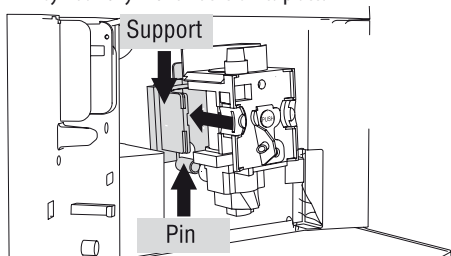

Please Note!

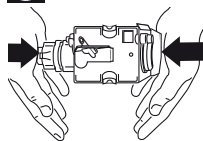

If you encounter difficulty inserting the infuser, before inserting it you must adapt it to the right dimension by pressing it forcefully from the bottom and top as shown in the figure.

shown in the figure.

7. Once inserted, make sure the two red buttons have snapped out.
8. Replace the drip tray and grounds container.
9. Close the service door.

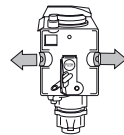

Cleaning the milk container

Clean the milk container each time you prepare milk as described below:

1. Turn the lid of the milk container clockwise then remove it.
2. Remove the milk spout and intake tube.
3. Remove the froth regulator by pulling it outwards.
4. Wash all the components thoroughly with hot water and mild dish soap.

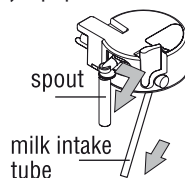

All components can be washed in a dishwasher, placing them in the top basket of the dishwasher.

Make sure there are no milk residues left inside the holes and the groove on the fine end of the froth regulator.

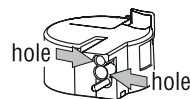
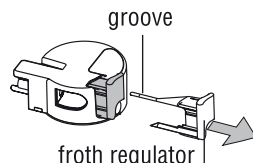

5. Use the brush supplied (certain models only) or another brush (not metal) to remove residues from the milk hole.
6. Check that the intake tube and spout are not clogged with milk residues.
7. Replace the froth regulator, milk spout and intake tube.
8. Replace the lid on the milk container, turning it anti-clockwise to hook it in place.

Cleaning the graphic touch screen

1. If the machine is on, turn off by pressing the  button (fig. 5) to avoid starting it accidentally during cleaning.
2. Clean the graphic touch screen with a damp cloth. Do not use solvents, aggressive detergents and/or sharp objects as they could damage the surface of the screen.

DESCALING

Descal the machine when the message "DESCALE!" flashes on the display.



Descaler contains acids which may irritate the skin and eyes. It is vital to respect the manufacturer's safety warnings given on the descaler pack and the warnings relating to the procedure to follow in the event of contact with the skin and eyes.



Use De'Longhi descaler only.

Under no circumstances should you use sulphamic or acetic based descalers. Their use invalidates the guarantee. Failure to descale the appliance as described also invalidates the guarantee.

1. Turn the machine on.
2. Choose the "MAINTENANCE" section as described in the section "Menu settings".
3. Press the selection icons until "Descal" is displayed.
4. Press the icon to confirm. "OK to confirm" is displayed. Press the icon again to enable the function.
5. The message "Add descaler Press OK" is displayed.
6. Before confirming, empty the water tank (A7).
Pour the descaler diluted with water (respecting the proportions indicated on the descaler pack) into the water tank and replace it in the appliance.
Place an empty container with a minimum capacity of 1.5 liters under the hot water spout.



Hot water containing acid flows out of the hot water spout. Avoid contact with splashes of water.

7. Press the selection icon corresponding to OK to start the descaling program.
8. The message "Descaling..." is displayed.
The descaling program starts and the descaler liquid comes out of the water spout.
The descale program automatically performs a series of rinses and pauses to remove limescale deposits from inside the machine.

After about 30 minutes, the message "Rinsing FILL TANK!" is displayed.

9. The appliance is now ready for rinsing through with clean water.
Remove the water tank, empty, rinse under running water, fill with clean water and replace. "Rinsing... Press OK" is displayed.
10. Empty the container used to collect the descaler solution

and replace it under the hot water spout.

11. Press the selection icon corresponding to OK to start rinsing. Hot water flows out of the spout and the message "Rinsing..." is displayed.
12. When the water tank is completely empty, the message "Rinsing Complete... Press OK" is displayed.
13. Press the selection icon corresponding to **OK**. The appliance goes off.

To use it again, turn the appliance on by pressing the button.

SETTING WATER HARDNESS

The DESCALE message is displayed after a period of time established according to water hardness.

The machine is set by default for a hardness value of 4.

The machine can also be programmed according to the actual hardness of the main water supply in the various regions, varying the frequency with which the message is displayed.

Measuring water hardness

1. Remove the "TOTAL HARDNESS TEST" indicator paper from its pack.
2. Immerse the paper completely in a glass of water for one second.
3. Remove the paper from the water and shake lightly. After about a minute, 1, 2, 3, or 4 red squares form, depending on the hardness of the water. Each square corresponds to one level.

soft water

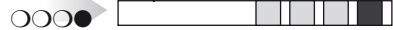

slightly hard water



hard water



very hard water









Set water hardness

1. Choose the "SETTINGS" section as described in the section "Menu settings".
 2. Press the selection icons until "Water Hardness" is displayed.
 3. Press the icon to confirm.
 4. Press the selection icons to set the level corresponding to the water hardness identified by the indicator paper (see figure (see figure above)).
 5. Press the icon to confirm the setting.
 6. Press the **P** icon a number of times to exit the menu.
- The machine is now reprogrammed with the new water hardness setting.

TECHNICAL SPECIFICATION

Voltage:	120 V~ 60 Hz max. 10A
Absorbed power:	1350W
Pressure:	15 bar
Water tank capacity:	1,8 L
Size: LxHxD:	282x380x441 mm
Cable length:	1,5 m
Weight:	11,5 Kg
Beans container capacity	250 g

DISPLAYED MESSAGES

DISPLAYED MESSAGE	POSSIBLE CAUSE	SOLUTION
FILL TANK! 	<ul style="list-style-type: none"> Insufficient water in the tank. 	<ul style="list-style-type: none"> Fill the tank with water and/or insert it correctly, pushing it as far as it will go until it clicks into place.
GROUND TOO FINE ADJUST MILL! Insert water spout and press OK	<ul style="list-style-type: none"> The grinding is too fine and the coffee is delivered too slowly or not at all. 	<ul style="list-style-type: none"> Repeat coffee delivery and turn the grinding adjustment dial one click clockwise towards "7" while the coffee mill is in operation. If after making at least 2 coffees delivery is still too slow, repeat the correction procedure, turning the grinding adjustment dial another click until delivery is correct. If the problem persists, press the icon corresponding to OK and deliver water from the spout until it flows out normally.
INSERT WATER SPOUT!	<ul style="list-style-type: none"> The water spout is not inserted or is inserted incorrectly. 	<ul style="list-style-type: none"> Insert water spout as far as it will go.
EMPTY GROUNDS CONTAINER! 	<ul style="list-style-type: none"> The grounds container is too full or more than 3 days have passed since you last made coffee (this guarantees correct hygiene of the machine). 	<ul style="list-style-type: none"> Empty the grounds container and clean, then replace. Important: when removing the drip tray, the grounds container must be emptied, even if it contains few grounds. If this is not done, when you make the next coffees, the grounds container may fill up more than expected and clog the machine.
INSERT GROUNDS CONTAINER 	<ul style="list-style-type: none"> After cleaning, the grounds container has not been replaced. 	<ul style="list-style-type: none"> Open the service door, remove the drip tray and insert the grounds container.
ADD PRE-GROUND COFFEE 	<ul style="list-style-type: none"> The "ground coffee" function has been selected without placing any pre-ground coffee in the funnel. The funnel is clogged. 	<ul style="list-style-type: none"> Place pre-ground coffee in the funnel or deselect the "ground coffee" function. Empty the funnel with the help of the spatula on the cleaning brush provided, as described in the section "Cleaning the pre-ground coffee funnel".
DESCALE!	<ul style="list-style-type: none"> The machine must be descaled. 	<ul style="list-style-type: none"> The descaling procedure described in the "Descaling" section needs to be performed as soon as possible.
LESS COFFEE! 	<ul style="list-style-type: none"> Too much coffee has been used. 	<ul style="list-style-type: none"> Select a milder taste or reduce the quantity of pre-ground coffee and then request the coffee again.
FILL BEANS CONTAINER! 	<ul style="list-style-type: none"> The coffee beans have run out. The pre-ground coffee funnel is clogged. 	<ul style="list-style-type: none"> Fill the beans container Empty the funnel with the help of a brush as described in the section "Cleaning the pre-ground coffee funnel".
INSERT INFUSER ASSEMBLY! 	<ul style="list-style-type: none"> The infuser has not been replaced after cleaning. 	<ul style="list-style-type: none"> Insert the infuser as described in the paragraph "Cleaning the infuser".

DISPLAYED MESSAGE	POSSIBLE CAUSE	SOLUTION
INSERT MILK CONTAINER	<ul style="list-style-type: none"> The milk container is not inserted correctly. 	<ul style="list-style-type: none"> Insert the milk container as far as it will go.
CLOSE DOOR! 	<ul style="list-style-type: none"> The service door is open 	<ul style="list-style-type: none"> Close the service door.
PRESS CLEAN BUTTON	<ul style="list-style-type: none"> Milk has been delivered recently and the tubes inside the milk container must be cleaned. 	<ul style="list-style-type: none"> Press the CLEAN button and keep it pressed until the progress bar which appears on the display together with the message "Cleaning..." is complete.
Energy Saving	<ul style="list-style-type: none"> The function is active and reduces electricity consumption. 	<ul style="list-style-type: none"> Disable the function in the menu (see section: "Energy Saving").
GENERAL ALARM!	<ul style="list-style-type: none"> The inside of the appliance is very dirty. 	<ul style="list-style-type: none"> Clean the inside of the appliance thoroughly, as described in the section "Cleaning". If the message is still displayed after cleaning, contact a service center.

TROUBLESHOOTING

Below is a list of some of the possible malfunctions.

If the problem cannot be resolved as described, contact a Service Center.

PROBLEM	POSSIBLE CAUSE	SOLUTION
The coffee is not hot	<ul style="list-style-type: none"> The cups were not preheated. 	<ul style="list-style-type: none"> Enable the cup warmer, leave the cups at least 20 minutes to warm up. Warm the cups by rinsing them with hot water (using the hot water function).
	<ul style="list-style-type: none"> The infuser has cooled down because 2/3 minutes have elapsed since the last coffee was made. 	<ul style="list-style-type: none"> Before making the coffee, heat the infuser by pressing the  icon (see the sections "Tips for a hotter coffee").
	<ul style="list-style-type: none"> A low coffee temperature is set. 	<ul style="list-style-type: none"> Set a high coffee temperature in the menu.
The coffee is not creamy enough.	<ul style="list-style-type: none"> The coffee is ground too coarsely. 	<ul style="list-style-type: none"> Turn the grinding adjustment dial one click anticlockwise towards "1" while the coffee mill is in operation (fig. 10). Continue one click at a time until coffee delivery is satisfactory. The effect is only visible after delivering 2 coffees.
	<ul style="list-style-type: none"> Wrong type of coffee 	<ul style="list-style-type: none"> Use a type of coffee for espresso coffee makers.
The coffee is delivered too slowly or a drop at a time.	<ul style="list-style-type: none"> The coffee is ground too finely. 	<ul style="list-style-type: none"> Turn the grinding adjustment dial one click clockwise towards "7" while the coffee mill is in operation (fig. 10). Continue one click at a time until coffee delivery is satisfactory. The effect is only visible after delivering 2 coffees.
The coffee does not come out of the spouts, but from around the service door.	<ul style="list-style-type: none"> The holes in the spouts are clogged with dry coffee dust. 	<ul style="list-style-type: none"> Clean the spouts with a toothpick, sponge or hard bristled kitchen brush.
	<ul style="list-style-type: none"> The coffee guide inside the service door is blocked and cannot swing. 	<ul style="list-style-type: none"> Thoroughly clean the coffee guide, particularly near the hinges.

PROBLEM	POSSIBLE CAUSE	SOLUTION
The coffee is delivered too quickly.	<ul style="list-style-type: none"> The coffee is ground too coarsely. 	<ul style="list-style-type: none"> Turn the grinding adjustment dial one click anticlockwise towards "1" while the coffee mill is in operation (fig. 10). Avoid turning the grinding adjustment dial excessively otherwise when you select two cups, the coffee may be delivered a drop at a time.
Coffee does not come out of one of the spouts.	<ul style="list-style-type: none"> The spouts are blocked. 	<ul style="list-style-type: none"> Clean the spouts with a toothpick (fig. 38).
Water comes out of the spouts instead of coffee.	<ul style="list-style-type: none"> The pre-ground coffee may be blocked in the funnel (A4). 	<ul style="list-style-type: none"> Empty the funnel with the help of the spatula on the cleaning brush provided, as described in the section "Cleaning the pre-ground coffee funnel".
The milk contains bubbles or squirts out of the milk spout.	<ul style="list-style-type: none"> The milk is not cold enough or is not skim or 2% milk. 	<ul style="list-style-type: none"> You should ideally use skim or 2% milk at refrigerator temperature (about 41°F / 5°C). If the result is not as you wished, try changing brand of milk.
	<ul style="list-style-type: none"> The froth regulator is incorrectly adjusted. 	<ul style="list-style-type: none"> Adjust following the instructions in the section on preparing drinks with milk.
	<ul style="list-style-type: none"> The milk container lid is dirty. 	<ul style="list-style-type: none"> Clean the milk container lid as described in the section "Cleaning the milk container".
The milk is not frothed.	<ul style="list-style-type: none"> The froth regulator is incorrectly adjusted. 	<ul style="list-style-type: none"> Adjust following the instructions in the section on preparing drinks with milk.
	<ul style="list-style-type: none"> The milk container lid is dirty. 	<ul style="list-style-type: none"> Clean the milk container lid as described in the section "Cleaning the milk container".
The appliance does not come on.	<ul style="list-style-type: none"> It is not plugged into the mains socket. 	<ul style="list-style-type: none"> Plug into the mains socket.
	<ul style="list-style-type: none"> The main switch is not turned on. 	<ul style="list-style-type: none"> Place the main switch in the I position (fig. 1).
The milk does not come out of the milk spout.	<ul style="list-style-type: none"> The milk container lid is dirty. 	<ul style="list-style-type: none"> Clean the milk container lid as described in the section "Cleaning the milk container".
"Energy Saving" mode is enabled, but the cup warmer is hot.	<ul style="list-style-type: none"> A number of drinks have been prepared in rapid succession. 	

LIMITED WARRANTY

This warranty applies to all products with De'Longhi or Kenwood brand names.

What does the warranty cover?

We warrant each appliance to be free from defects in material and workmanship. Our obligation under this warranty is limited to repair at our factory or authorized service center of any defective parts or part thereof, other than parts damaged in transit. In the event of a products replacement or return, the unit must be returned transportation prepaid. The repaired or new model will be returned at the company expense.

This warranty shall apply only if the appliance is used in accordance with the factory directions, which accompany it, and on an Alternating current (AC) circuit.

How long does the coverage last?

This warranty runs for two years (2) from the purchase date found on your receipt and applies only to the original purchaser for use.

What is not covered by the warranty?

The warranty does not cover defects or damage of the appliance, which result from repairs or alterations to the appliance outside our factory or authorized service centers, nor shall it apply to any appliance, which has been subject to abuse, misuse, negligence or accidents. Also, consequential and incidental damage resulting from the use of this product or arising out of any breach of contract or breach of this warranty are not recoverable under this warranty. Some states do not allow the exclusion or limitation of incidental or consequential damage, so the above limitation may not apply to you.

How do you get service?

If repairs become necessary, see contact information below:

U.S. Residents: Please contact our toll free hotline at 1-866-528-8323 (1-866-Latte-Best) or log onto our website at www.delonghi.com

Residents of Canada: Please contact our toll free hotline at 1-888-335-6644 or log onto our website at www.delonghi.com

Residents of Mexico: Please contact our toll free number 01-800-711-8805 for assistance or log onto our website at www.delonghi.com

The above warranty is in lieu of all other express warranties and representations. All implied warranties are limited to the applicable warranty period set forth above. This limitation does not apply if you enter into an extended warranty with De'Longhi. Some states/countries do not allow limitations on how long an implied warranty lasts, so the above exclusions may not apply to you. De'Longhi does not authorize any other person or company to assume for it any liability in connection with the sale or use of its appliance.

How does country law apply?

This warranty gives you specific legal rights, and you may also have other rights, which vary from state to state/country to country.