



FH2133

IDEAL FRY



DeLonghi

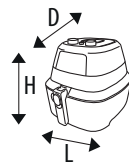
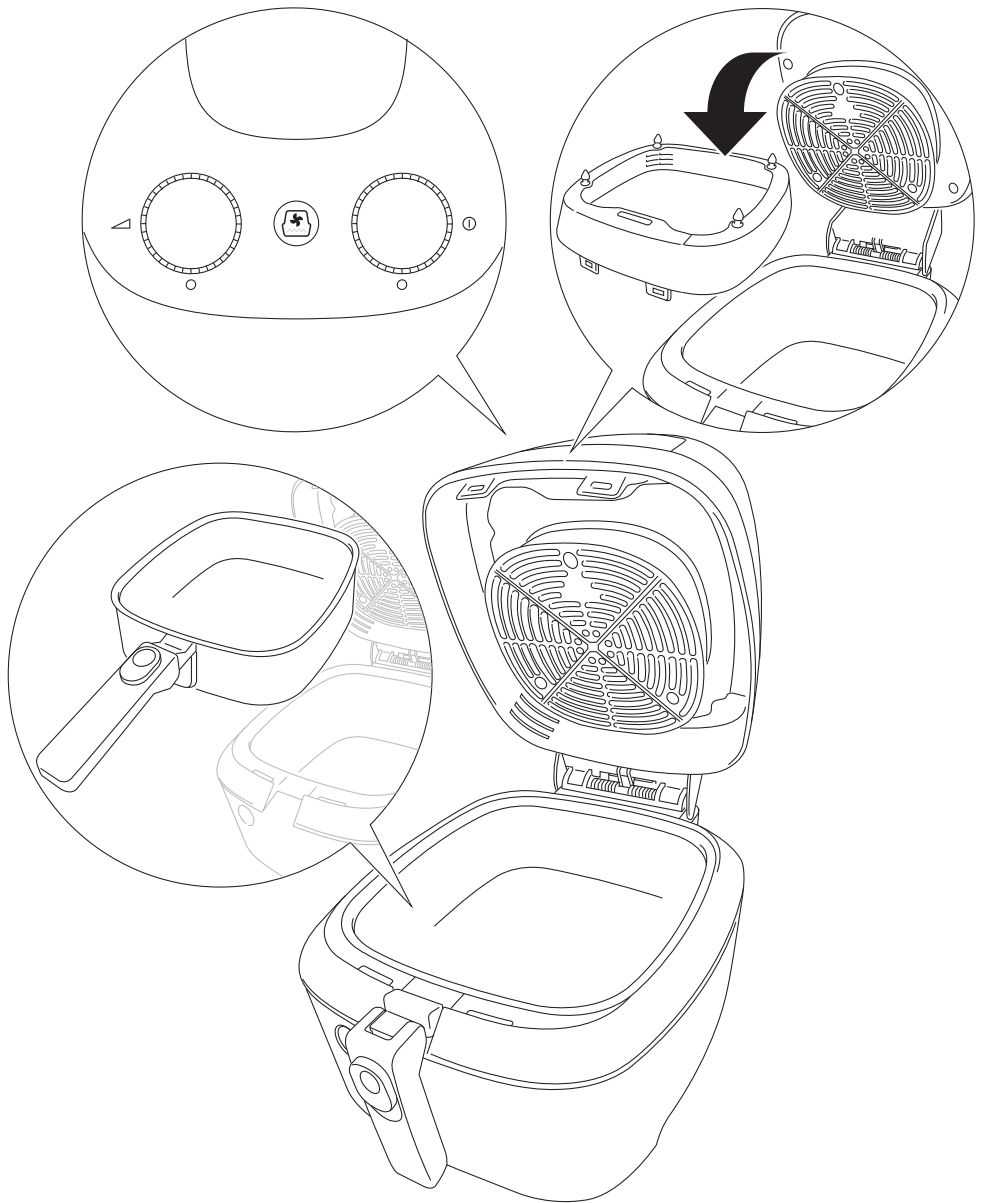

(LxHxD): 290x290x390 mm



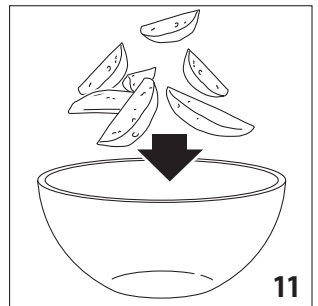
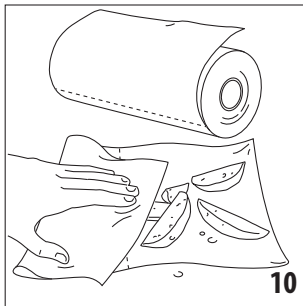
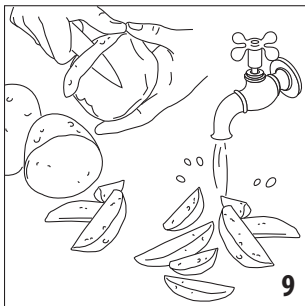
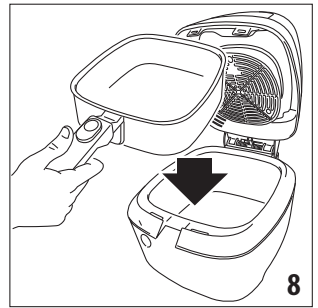
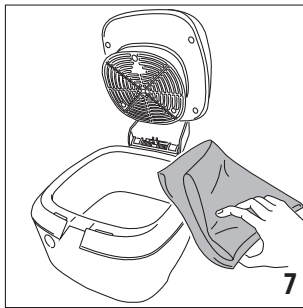
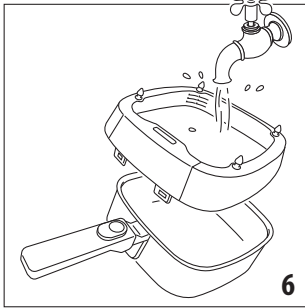
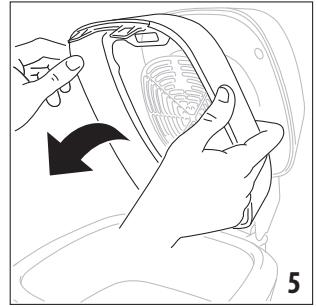
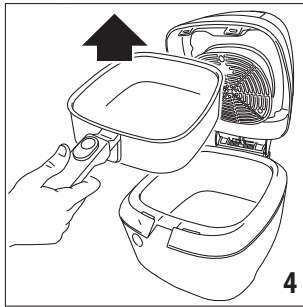
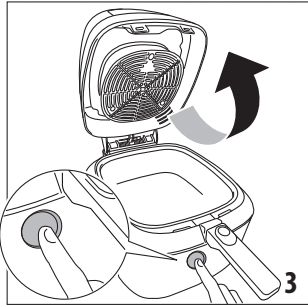
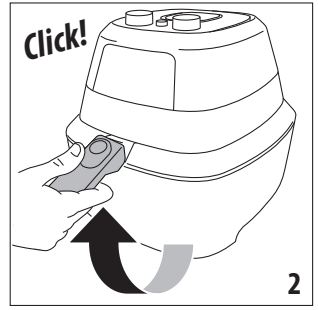
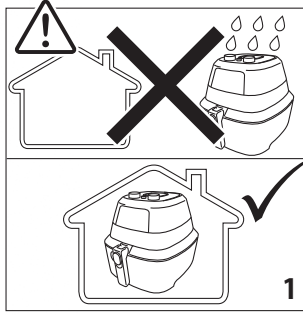

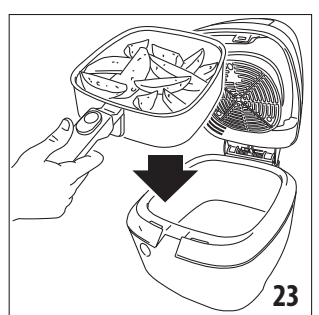
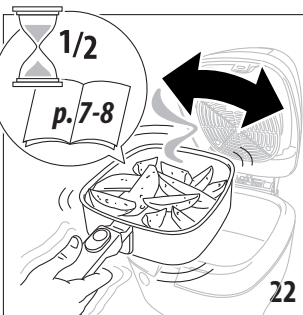
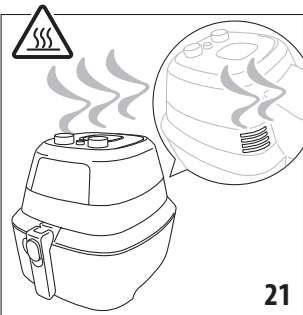
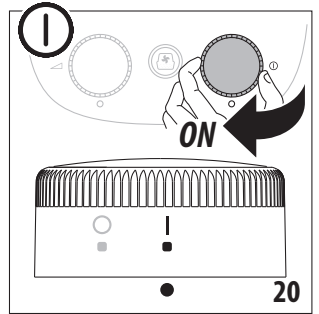
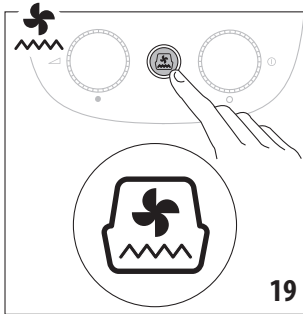
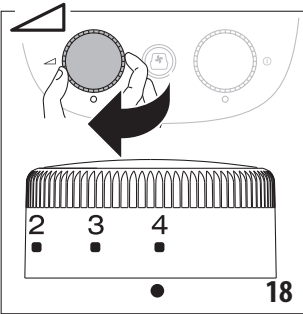
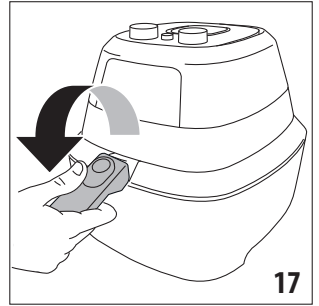
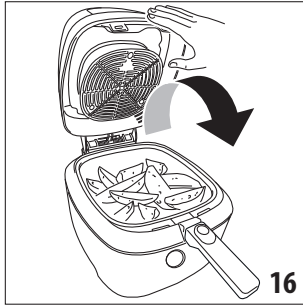
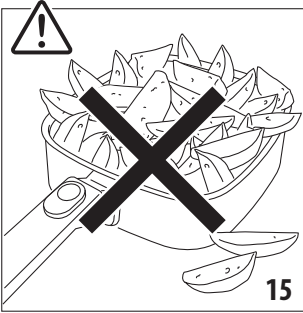
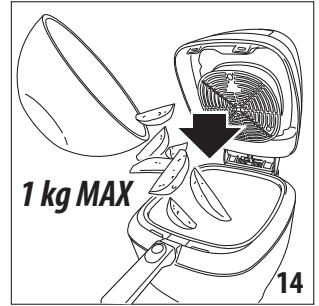
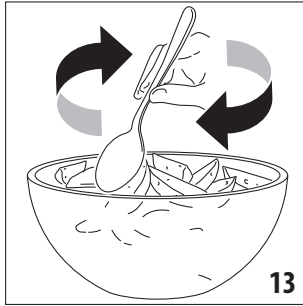
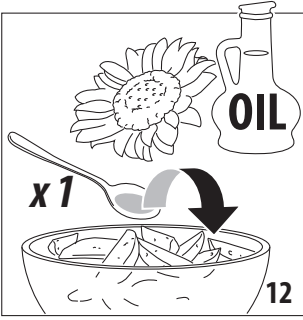

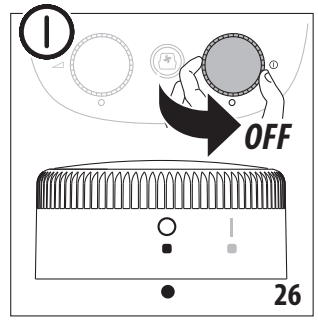
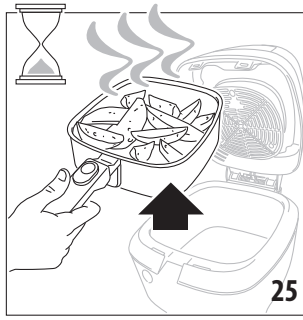
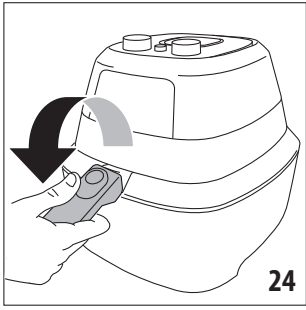

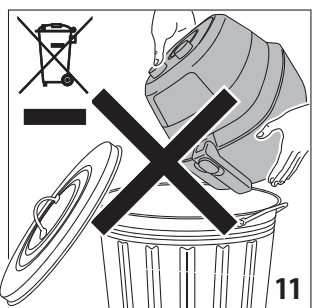
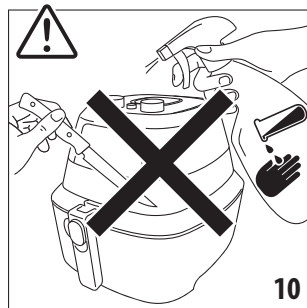
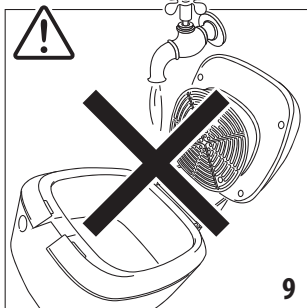
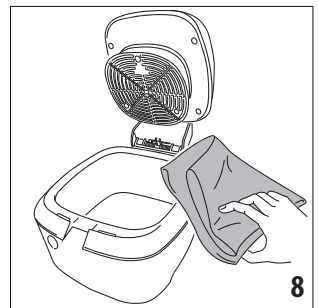
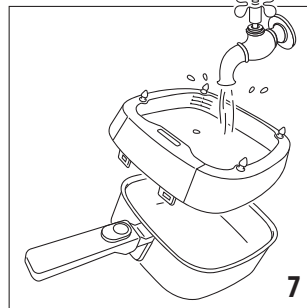
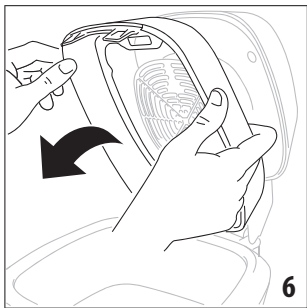
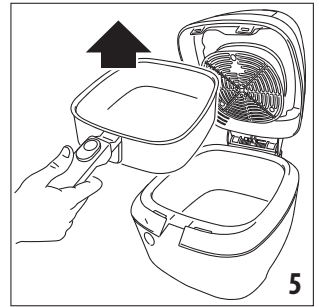
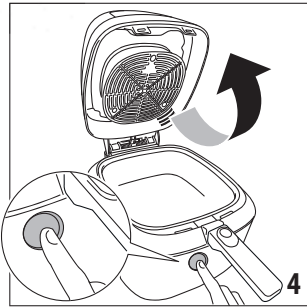
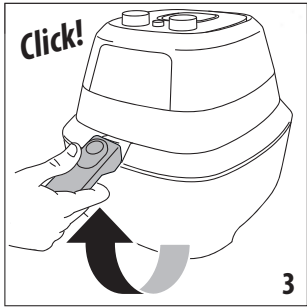
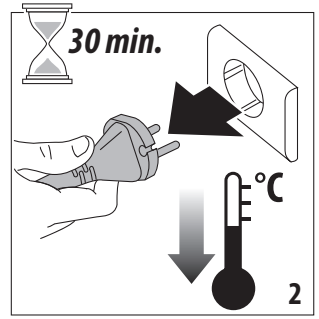
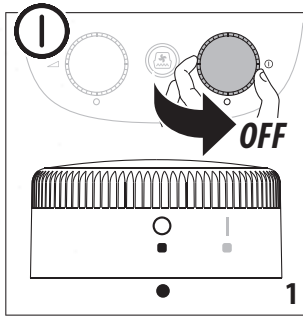



 5.3 kg



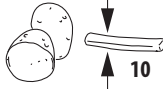



























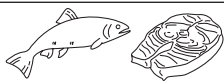











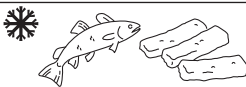



		 min.				
	1.25 (*)	28-30	4	√	√	√
	1 (*)	23-25	4	√	√	√
	0.75 (*)	20	4	√	√	1/2
	0.5 (*)	15	4	√	√	1/2
	1	25-28	4	√	√	-
	0.75	20-22	4	√	√	-
	0.5	17	4	√	√	-
	0.25	12	4	√	√	-
	1	23-26	4	√	√	-
	0.75	18-20	4	√	√	-
	0.5	15	4	√	√	-
	0.25	10	4	√	√	-
	1.25 (*)	25-30	4	√	√	-
	0.75	22-27	4	√	√	-
	0.6	20-25	4	√	√	-

(*) da pelare - un-peeled potato weight - à éplucher - ungeschält - te schillen - para pelar - a serem descascadas - για καθάρισμα - следует очистить - hámozandó - k loupání - je potrebné ich očistiť - do obrania - må skrelles - skalad - skal skrælles - kuorittuina - neoguljen - olupiti - за бeленe - präjiti - kabukları soyulmuş - سبب زمینی معمولی - يجب تقشيرها

		 min.				
	0.8	30-35	3	√	√	-
	0.45	18-20	4	-	√	-
	0.4	13-15	4	-	√	1
	1.2	40-45	3	√	-	-

		 min.				
	0.6	15-20	3	√	-	-
	0.45	13-15	3	√	-	1

		 min.				
	0.4	20-25	3	√	-	1
	0.7	30-35	2	√	-	-
	0.3	15	3	√	-	-
	0.25	12	3	√	-	-
	0.15	8-10	3	√	-	-

		 min.				
	0.75	30-35	2	√	-	-
	(x 4) 0.25	25-30	2	√	-	-
	0.3	16-18	2	√	-	-