

Register Now 
www.delonghi.com/register

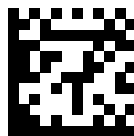

FS3061



FRIGGITRICE ELETTRICA
ELECTRIC FRYER
FRITEUSE ELECTRIQUE
ELEKTRONISCHE FRITTEUSE
FRITEUSE
FREIDORA ELÉCTRICA
FRITADEIRA ELÉCTRICA
НАЛЕКТРИКН ФРИТЕЗА
ЭЛЕКТРИЧЕСКАЯ ФРИТЮРНИЦА
ELEKTROMOS OLAJSÜTŐ
ELEKTRICKÁ FRITÉZA
ELEKTRICKÁ FRITÉZA
FRYTOWNICA ELEKTRYCZNA
ELEKTRISK FRITYRGRYTE
ELEKTRISK FRITTÖS
ELEKTRISK FRITUREGRYDE
ELEKTRONINEN RASVAKEITIN
ELEKTRIČNA FRITEZA
ELEKTRIČNI CVRTNIK
ЭЛЕКТРИЧЕСКИ ФРИТЮРНИК
FRITEUZĂ ELECTRICĂ
ELEKTRIKLI FRITÖZ
ЭЛЕКТРЛИК ҚУЫРМА ҮДЫС
سرخ کن برقی
مقلدة كهربائية

DeLonghi

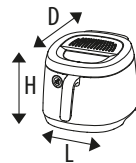
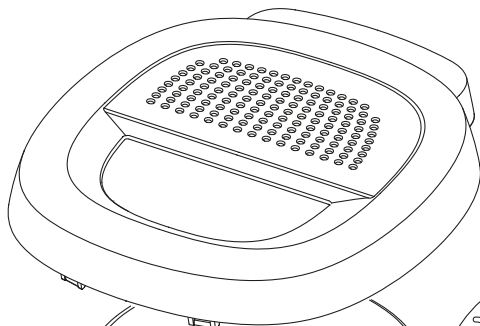

(LxHxD): 293x232x417 mm

 FS3061 2.65 kg

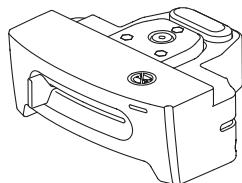
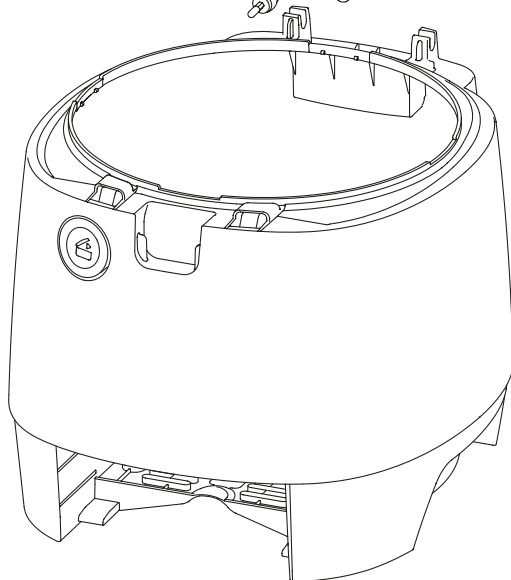
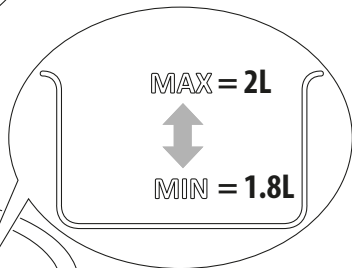
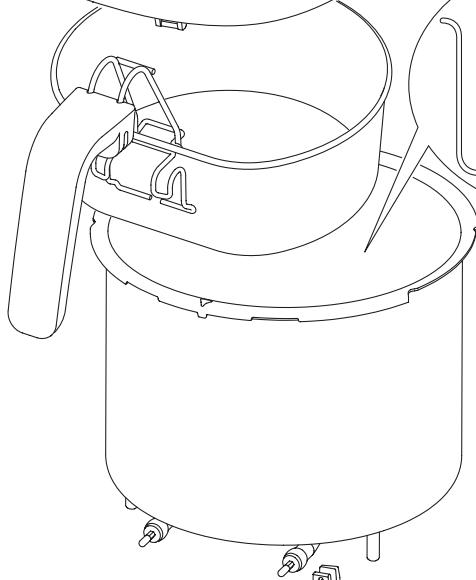

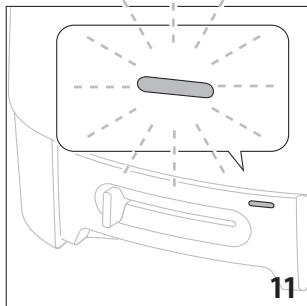
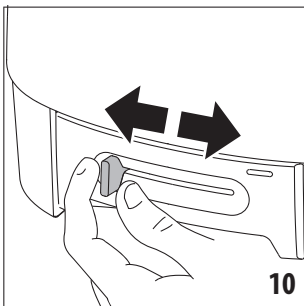
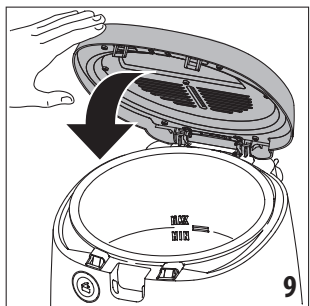
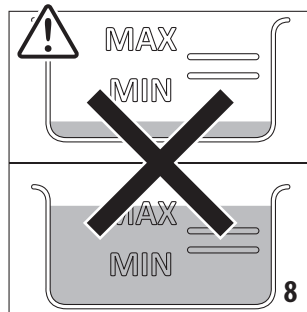
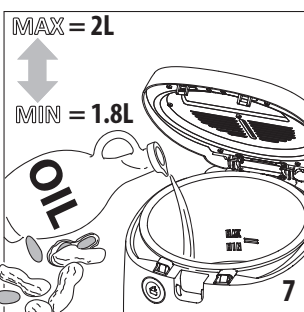
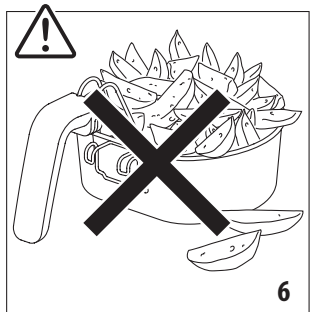
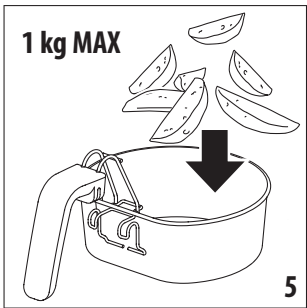
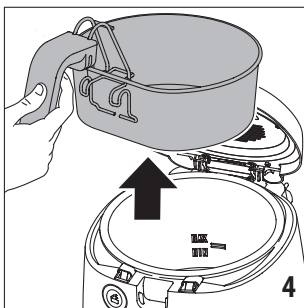
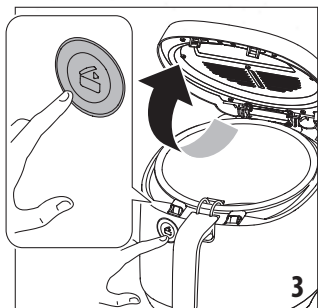
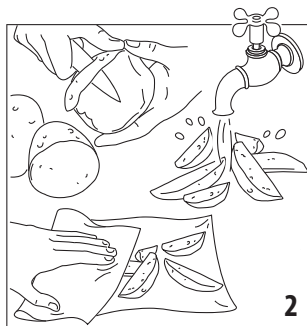
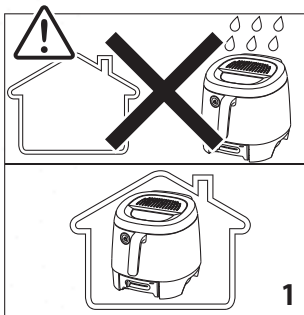

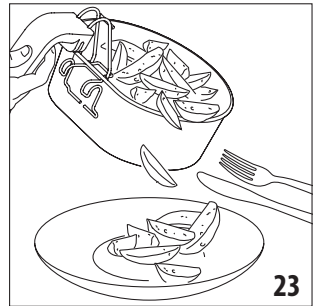
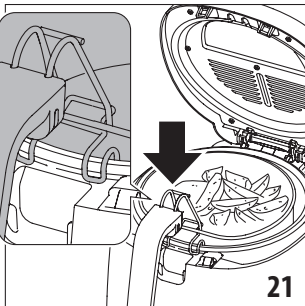
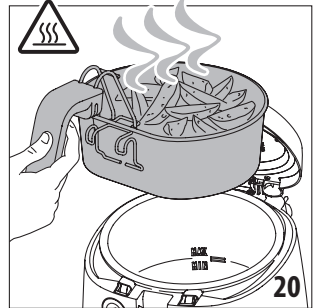
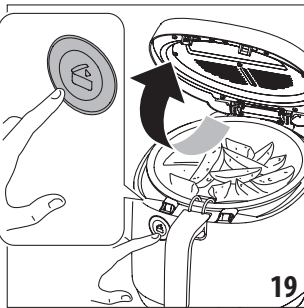
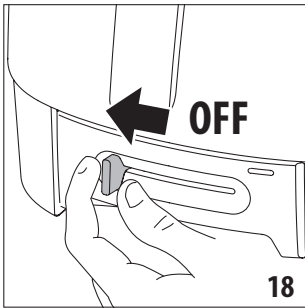
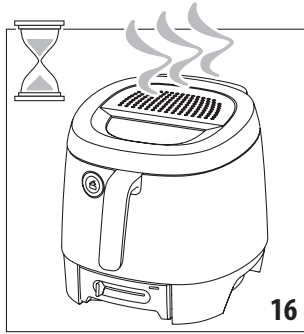
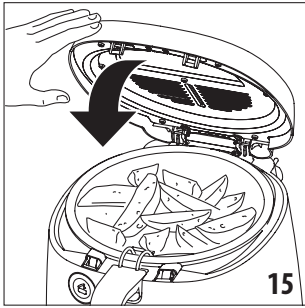
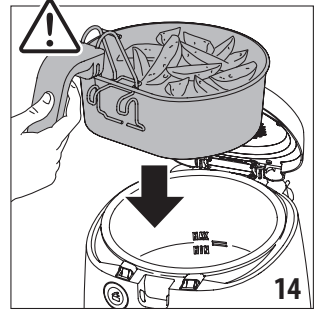
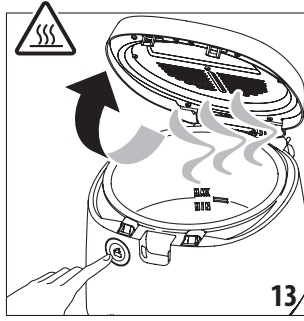
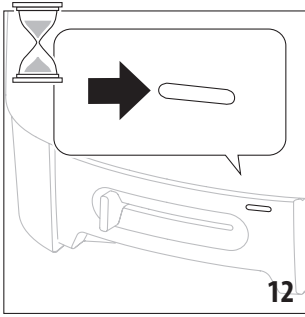

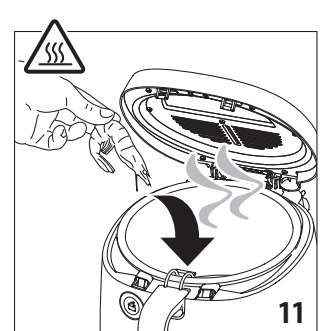
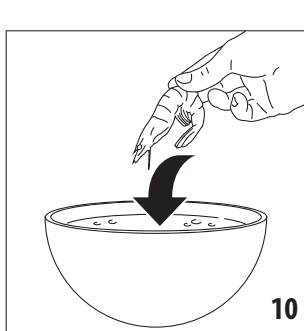
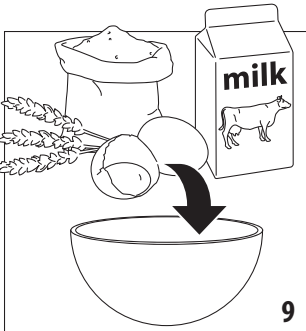
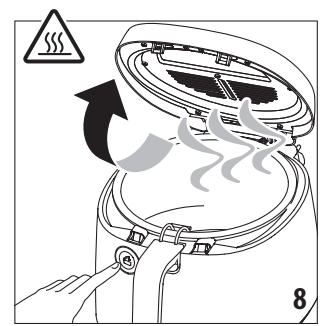
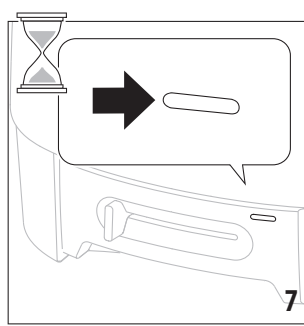
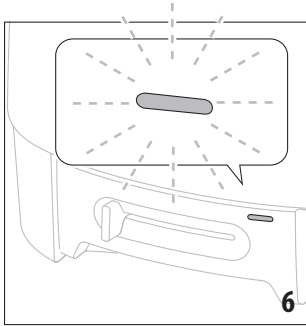
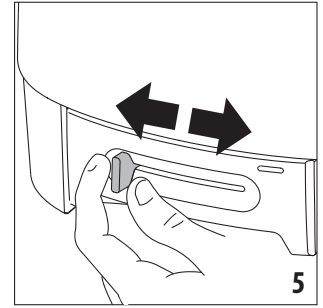
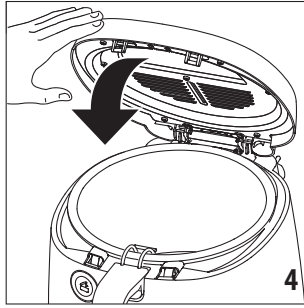
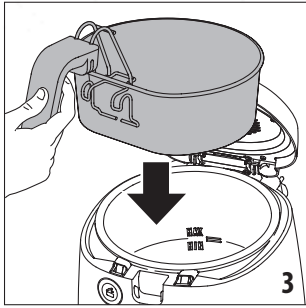
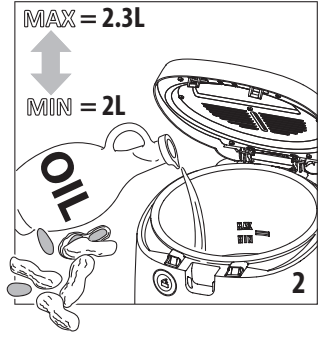
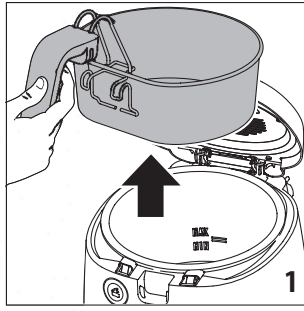

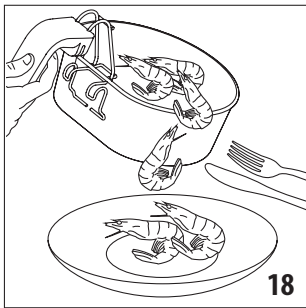
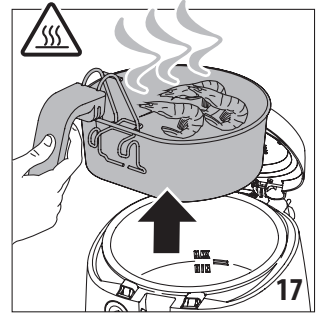
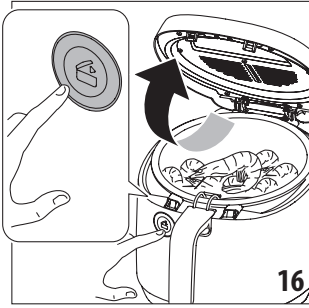
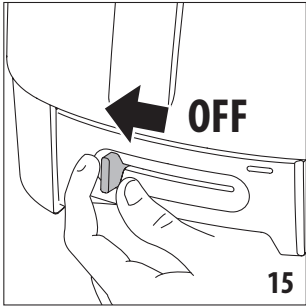
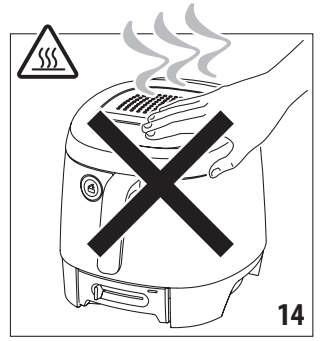
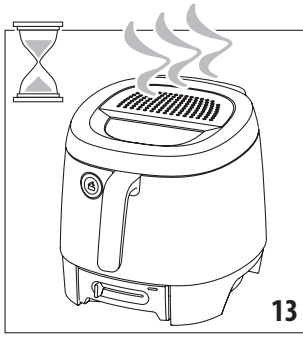
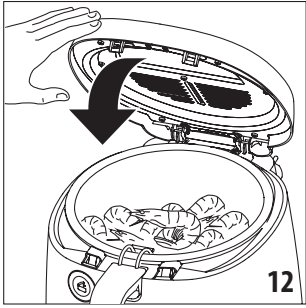





















							
		 °C		 °C			
	1.2 (max) (*)	-	-	190	16-18		
	0.75 (*)	-	-	190	9-11		
	1 (max)	190	14-16	-	-		
	0.5	190	6-8	-	-		
	3 pz	-	-	160	20-25	√	
	0.35	190	4-5	-	-		
	0.35	-	-	170	4-5	√	
	0.3	190	4-5	170	6-8	√	
	0.4	190	4-5	170	5-7	√	
	0.3	-	-	170	6-8	√	
	0.2	-	-	170	3-5	√	
	0.4	190	3-4	-	-		
	0.2	-	-	160	5-6	√	
	0.3	190	4-5	160	4-6	√	
	4 pz	-	-	180	5-6		

(*) da pelare - un-peeled potato weight - à éplucher - ungeschält - te schillen - para pelar - a serem descascadas - για καθάρισμα - следует очистить - hámozandó - k loupání - je potřebné ich očistiť - do obrania - mǎ skrelles - skalad - skal skrælles - kuorittuina - neoguljen - olupiti - за белене - pražiti - bakukları soyulmuş - یجب زبيني معمولی - سیب زمینی معمولی

