

Register Now 
www.delonghi.com/register

De'Longhi Appliances via Seitz, 47 31100 Treviso Italia www.delonghi.com

5713238051_01_0618

ICM16 series

COFFEE MAKER
MACHINE À CAFÉ

جهاز إعداد القهوة



DeLonghi

EN

page 6

FR

page 10

AR

2

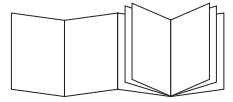

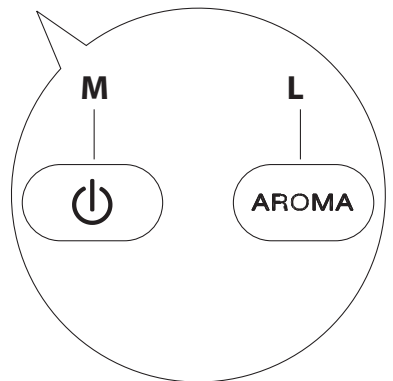
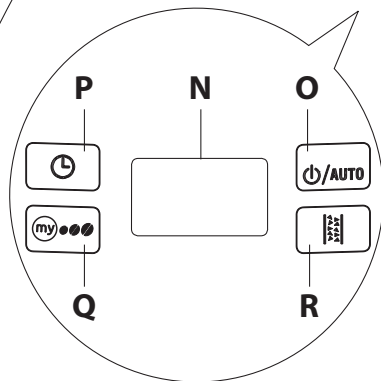
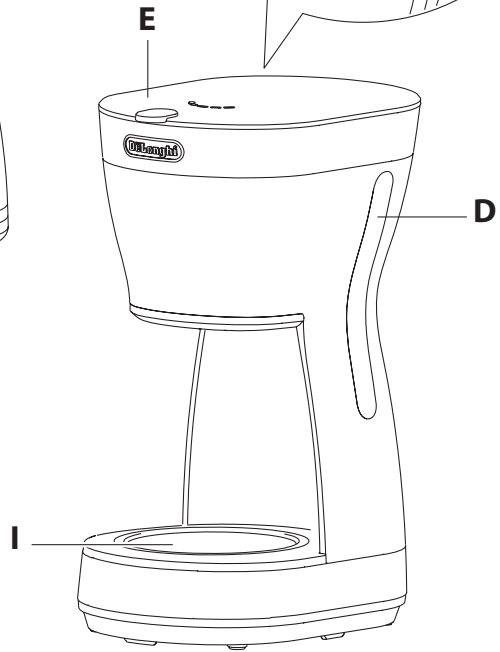
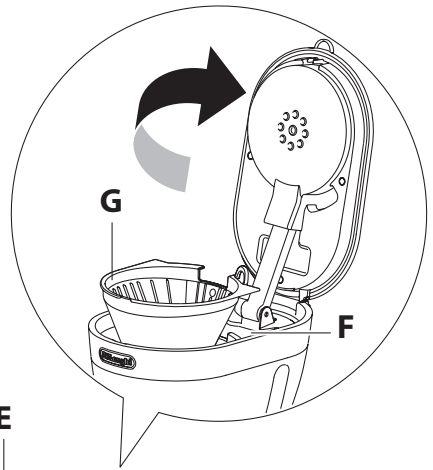
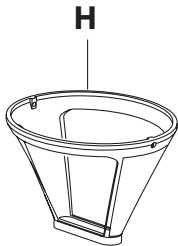
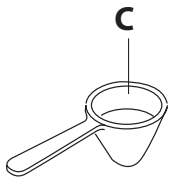
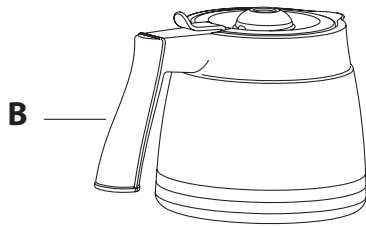
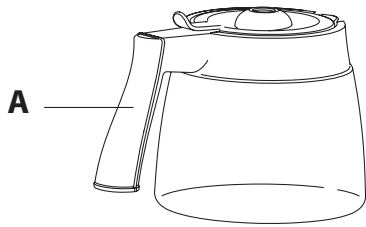

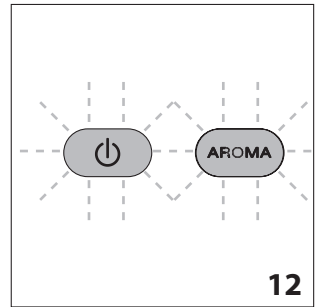
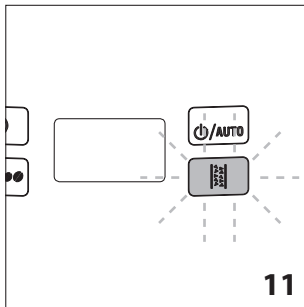
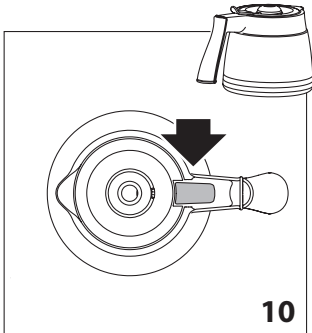
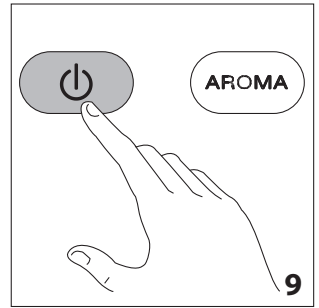
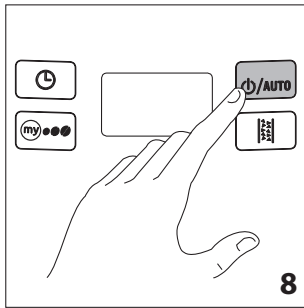
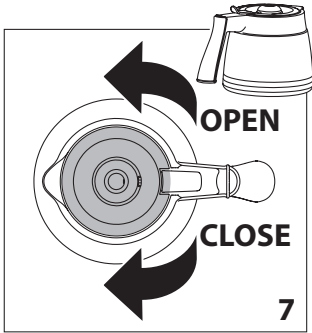
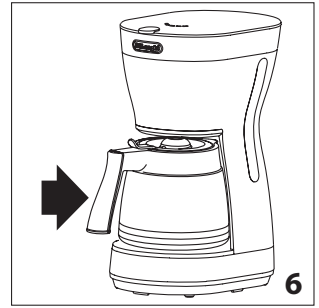
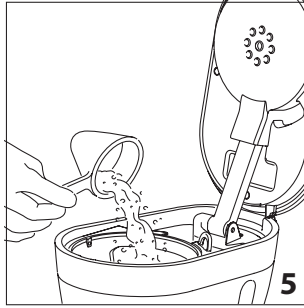
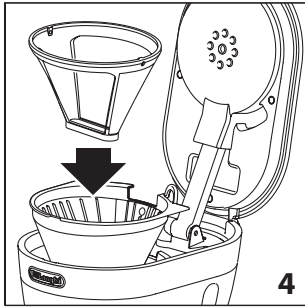
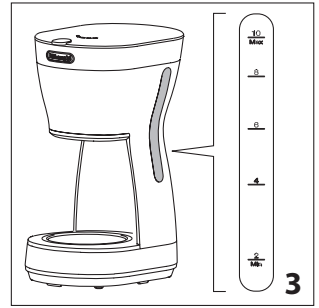
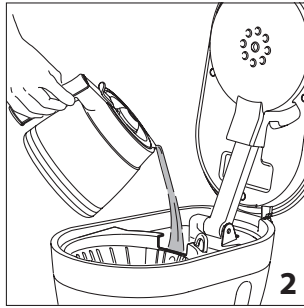
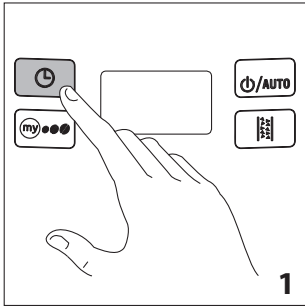

IMPORTANT SAFEGUARDS

Danger!

Failure to observe the warning may result in life threatening injury by electric shock.

- The power cable of this appliance must not be replaced by the user as the operation requires the use of special tools.

If it is damaged or must be replaced, contact De'Longhi Customer Services to avoid all risk.

- Never immerse the coffee maker in water. It is an electrical appliance.
- Unplug the appliance and turn off the main switch when not in use. Do not leave the appliance switched on unnecessarily.
- As with all electrical appliances, use the coffee maker with care and common sense, particularly in the presence of children.
- Check that the voltage of the mains power supply corresponds to the value indicated on the appliance rating plate. Connect the appliance to an efficiently earthed electrical socket with a minimum rating of 10A only. The manufacturer declines all liability for any accidents caused by the absence of an efficient earth system.
- If the power socket does not match the plug on the appliance, have the socket replaced with a suitable type by a qualified electrician.
- When filling the water tank or removing the jug from the machine, avoid spilling liquid on the plug or power cable.

Danger of burns!

Failure to observe the warning could result in scalds or burns.

- This appliance is designed and made to "prepare coffee". Be careful to avoid being scalded by spraying water or steam or due to improper use of the appliance.
- When using the appliance do not touch the hot surfaces. Use the knobs or handles.
- Never touch the appliance with wet or damp hands or feet.
- The plate remains hot after the appliance has been used.

Important!

Failure to observe the warning could result in injury or damage to the appliance.

- The manufacturer is not liable for damage caused by inappropriate, incorrect or irresponsible use.
- In the event of failure or malfunction, unplug the appliance from the mains. If it requires repair, contact De'Longhi Customer Services only and ask for original spare parts to be used. Failure to respect the above could jeopardise the safety of the appliance.

- This appliance can be used by children aged from 8 years and above and persons with reduced physical, sensory or mental capabilities or lack of experience and knowledge if they have been given supervision or instruction concerning use of the appliance in a safe way and understand the hazards involved.

Children shall not play with the appliance.

Cleaning and user maintenance shall not be made by children without supervision. Keep the appliance and its cord out of reach of children aged less than 8 years.

- After removing the packaging, make sure the appliance is complete and undamaged. If in doubt, do not use the appliance and contact qualified personnel only.
- The packing elements (plastic bags, polystyrene foam, etc.) should be kept out of reach of children as they are a safety hazard.
- Place the appliance on a work surface far away from water taps, basins and sources of heat.
- Never install the appliance in environments where the temperature may reach 0°C or lower (the appliance may be damaged if the water freezes).

Please note:

This symbol identifies important advice or information for the user.

- Read this instruction booklet carefully before installing and using the appliance. This is the only way to ensure the best results and maximum safety for the user.

- This is a household appliance only.

It is not intended to be used in: staff kitchen areas in shops, offices and other working environment; farm houses; by clients in hotels, motels and other residential type environments; bed and breakfast type environments

Any other use is considered improper and thus dangerous.



- This appliance conforms to EC Regulation 1935/2004 on materials and articles intended to come into contact with food.
- After positioning the appliance on the work top, leave a space of at least 5 cm between the surfaces of the appliance and the side and rear walls and at least 20 cm above the coffee maker.

DESCRIPTION OF APPLIANCE

- A. Glass jug (certain models only)
- B. Thermal jug (certain models only)
- C. Measure
- D. Water level indicator
- E. Lid
- F. Water fill compartment
- G. Filter holder for drip coffee
- H. Permanent filter (if provided) or paper filter
- I. Plate (heats up in models with glass jug only)

Models with switch:

- L. AROMA button
- M. ⏻ On/stand by button

Electronic models:

- N. Display
- O. ⏻/AUTO button with light
- P. ⌚ Set timer/clock button
- Q. My aroma button
- R. Descale button
- S. Water tank filter

SETTING THE CLOCK (CERTAIN MODELS ONLY)

When turning on the appliance for the first time, the clock will show 12:00. To setup the clock keep pressed the ⌚ Timer/clock button (P) for more than 2s.

A single pressure of ⌚ Timer/clock button (P) increase with a step of one minute, keep pressing increase with more speed. After 3 seconds that the user doesn't press any button the clock is set and appliance turn to active mode.

SETTING THE TIMER (CERTAIN MODELS ONLY)

If the timer is not set the default timer is 6:00.

To setup the timer press the ⌚ Timer/clock button (P). When is enable the timer setup mode the clock icon will be on.

A single pressure of ⌚ Timer/clock button (P) increase with a step of one minute, keep pressing increase with more speed. After 3 seconds that the user doesn't press any button the timer is set and appliance turn to active mode, clock icon turn off.

HOW TO MAKE DRIP COFFEE

Please note: the first time the appliance is used, all accessories and the internal circuits must be washed through by making at least two jugs of coffee without using pre-ground coffee.

- Open the lid (E) at the top and use the jug to pour clean cold water into the water fill compartment (F) (fig. 2) up to the level indicated for the number of cups of coffee you want to make. Check the level of water in the tank through the level window (D) (fig. 3). You are recommended to use the jug provided as a measure as the maximum capacity of the jug and the tank are the same.
- Position the permanent filter (H) (if present) in the filter holder (G) (fig. 4). In versions without permanent filter, use the paper filter (size 1x4).
- Place the pre-ground coffee in the filter using the measure (C) provided and level evenly (fig. 5). See the table for recommended quantities. Use good quality, medium pre-ground coffee for drip coffee makers.

Recommended quantities:

No. cups	No. measures (*)
10	10
8	8
6	6
4	4
2	2





(*) 1 level measure = 1 tablespoon (5 g)





The quantities given in the table are indicative and should be adapted to your personal taste and the type of coffee. Never exceed the maximum quantity of 10 measures. The type of blend has a considerable influence on the coffee you make. You should therefore try various types of coffee to find the one best suited to your taste.

- **Models with glass jug (A):** close the lid (E) at the top of the appliance and place the closed jug on the plate (fig. 6).
- **Models with thermal jug (B):** before placing the jug on the plate, make sure the lid is closed (fig. 7).
- **Models with electronic controls:** The taste of the coffee can be optimized by pressing the My aroma button (Q). This function enables a process of percolation

which releases the water in the filter more slowly or quickly. Filtering a little at a time improves the flavour and aroma of the coffee. To select a different taste, press  My aroma button (Q) and you can loop between three different options.

To start the BREW press the /AUTO button (O) (fig. 8). The white light indicates that the coffee maker is operating and "BREW" appears on the display. The appliance emits a beep when delivery begins, then three beeps when it ends.

	
	Light
	Medium
	Strong

- **AUTO mode:** From the active mode the user can activate the AUTO mode with a long pressure, more than 2 seconds, of the /AUTO button (O) (fig. 8). The clock icon will turn on. The BREW will start at preset timer.
- **Models with switch:** Press the  On/stand by button (M) (fig. 9). The light on the switch indicates that the coffee maker is operating. Coffee delivery will start after a few seconds. The coffee maker emits a beep when delivery begins, then three beeps when it ends. The taste of the coffee can be optimised by pressing the AROMA button (L). This function enables a process of percolation which releases the water in the filter more slowly. Filtering a little at a time improves the flavour and aroma of the coffee. To enable the function, press the aroma button (the light on the button comes on). To disable the function, press the button again. You are recommended to use the AROMA button when you do not want to make a full jug of coffee.
- **In models with glass jug:** if you leave the  On/stand by button (M) pressed after percolation has finished, the plate will keep the coffee at the ideal temperature. The appliance goes off automatically 40 minutes after coffee delivery ends. To turn the plate off press the  On/stand by button (M) button again.
- It is completely normal for the appliance to give off steam while the coffee is percolating.
- For a new brewing cycle switch off the appliance pressing on/off button and restart .
- **Models with thermal jug:** to pour the coffee, press the button as shown in fig. 10. To remove the lid completely, turn the lid as shown in fig. 7. After percolation has ended, the appliance goes off automatically.
- For a new brewing cycle switch off the appliance pressing  On/stand by button (M) button and restart .

 **Please note:** removing the jug before all the coffee re-

quested has been delivered does not interrupt coffee making, but merely blocks flow into the jug. If you want to pour out a little coffee immediately, you should do so as rapidly as possible in order to avoid the coffee overflowing.

CLEANING AND MAINTENANCE

Before maintenance or cleaning of the appliance, turn off, unplug from the mains socket and allow to cool.



- Do not use solvents or abrasive detergents to clean the coffee maker. Just wipe with a soft damp cloth.
- Never immerse the coffee maker in water. It is an electrical appliance.
- The water tank filter (S) can be reached through the lid (E). Clean when necessary.

DESCALING

If the water in your area is hard, limescale builds up over time. These deposits may affect correct operation of the appliance. You are recommended to descale the coffee maker every 40 coffee making cycles.

Models with electronic controls only: When  Descal button (R) flashes (fig. 11), (about every 40 cycles) you have to descale the appliance.

Models with switch: When AROMA button (L) and  On/stand by button (M) flashes simultaneously (fig. 12), (about every 40 cycles) you have to descale the appliance.

- The appliance resets automatically after descaling.
- To descale, always use special commercially available descaling products for drip coffee makers.
- Dilute the product in the jug, following the instructions on the descaler pack;
- Pour the solution into the water fill compartment;
- Place the jug on the warming plate;
- Press the  Descal button (R) and then press /AUTO button (O) (in models with electronic controls)
or
press simultaneously the  On/stand by button (M) and AROMA button (L) for more than 1,5s (in models with switch), percolate the equivalent of one cup then turn the appliance off;
- Rinse by operating the appliance with water only at least 2 times (2 complete tanks of water).
- Failure to clean as described above invalidates the guarantee.

TECHNICAL DATA

Mains voltage:	220-240V-50-60Hz	
Absorbed power:	ICM16710	1200W
	ICM16210	1000W
	ICM16731	1200W
Weight:	ICM16	2.3 kg

low. The blue wire must be connected to the terminal marked with the letter N or coloured black. The brown wire must be connected to the terminal marked with the letter L or coloured red.

DISPOSING OF THE APPLIANCE



The appliance must not be disposed of with household waste, but taken to an authorised waste separation and recycling centre.

FAULT CONDITIONS

Display	Description	Solution
E1	Error water level	Fill water tank
E2	Timeout error	Descale

ELECTRICAL CONNECTION (UK ONLY)

A) If your appliance comes fitted with a plug, it will incorporate a 13 Amp fuse. If it does not fit your socket, the plug should be cut off from the mains lead, and an appropriate plug fitted, as below.

WARNING: Very carefully dispose of the cut off plug after removing the fuse: do not insert in a 13 Amp socket elsewhere in the house as this could cause a shock hazard. With alternative plugs not incorporating a fuse, the circuit must be protected by a 15 Amp fuse. If the plug is a moulded-on type, the fuse cover must be re-fitted when changing the fuse using a 13 Amp Asta approved fuse to BS 1362. In the event of losing the fuse cover, the plug must NOT be used until a replacement fuse cover can be obtained from your nearest electrical dealer. The colour of the correct replacement fuse cover is that as marked on the base of the plug.

B) If your appliance is not fitted with a plug, please follow the instructions provided below:

WARNING - THIS APPLIANCE MUST BE EARTHED

IMPORTANT

The wires in the mains lead are coloured in accordance with the following code:



Green and yellow: Earth
Blue: Neutral
Brown: Live

As the colours of the wires in the mains lead may not correspond with the coloured markings identifying the terminals in your plug, proceed as follows: The green and yellow wire must be connected to the terminal in the plug marked with the letter E or the earth symbol  or coloured green or green and yel-