

## INTRODUCTION

Thank you for choosing this De'Longhi product. Please take a few minutes to read these instructions. This will prevent running any risks or damaging the appliance.

### Symbols used in these instructions

Important warnings are identified using the symbols listed below. It is absolutely necessary to pay close attention to these warnings.

Failure to follow the indications given could lead to electrical shocks, serious injury, burns, fire or damage to the appliance.



Failure to comply could lead to injury from electrical shock and risk of death.



Failure to comply could lead to injury or damage to the appliance.



This symbol highlights advice and important information for the user.

### Problems and repairs

For any repairs, always consult the Technical Service Centres authorised by the manufacturing company. Always request original replacement parts. Repairs performed by unqualified personnel can be dangerous and void the warranty.

## WARNINGS

### Essential safety requirements

Only use the room air conditioner according to the instructions in this manual. These instructions do not cover every possible condition and situation that could occur. Common sense and prudence must always be followed during installation, operation and storage of any electrical appliance. This appliance was built for household use and must not be used for other purposes.



- This appliance can be used by children aged from 8 years and above and persons with reduced physical, sensory or mental capabilities or lack of experience

and knowledge if they have been given supervision or instruction concerning use of the appliance in a safe way and understand the hazards involved. Children shall not play with the appliance. Cleaning and user maintenance shall not be made by children without supervision.

- Do not set heavy or hot objects on the appliance.



Since the appliance uses electricity, the following safety instructions must be followed:

- Modifying or changing the characteristics of the appliance in any way is dangerous.
  - The appliance must be installed according to national laws governing electrical systems.
  - For any repairs, always consult the Technical Service Centres authorised by the manufacturing company. Repairs performed by incompetent individuals can be hazardous.
  - This appliance must be earthed. Have the electrical system checked by a qualified electrician.
  - Avoid using extension cords.
  - Before any cleaning or maintenance operation, always unplug from the mains.
  - Do not pull on the electrical cord to move the appliance.
  - Do not install the appliance in areas where the air may contain gas, oil or sulphur or near heat sources.
  - If the power cable is damaged, it must be replaced by the manufacturer or the manufacturer's Customer Services in order to avoid all risk.
- Please note:**
- Clean the air filter at least once a week.
  - When transporting, the appliance must be kept upright or resting on one side. Before transporting, drain all the water from the appliance. After transporting, wait at least one hour before turning on the appliance.
  - Do not cover the appliance with plastic bags when stored.
  - The packaging materials are recyclable. Please place them in the appropriate recycling collection containers.
  - At the end of its life, deliver the air conditioner to the appropriate collection centres.



**Check the plate for the type of refrigerant gas used in your appliance.**

### Specific information regarding appliances with R410A refrigerant gas

R410 is a refrigerant gas that complies with EC ecology regulations. Do not puncture the refrigerant circuit on the appliance.

**Environmental information:** This unit contains fluorinated greenhouse gases covered by the Kyoto Protocol. Maintenance and disposal must only be performed by qualified personnel (R410A, GWP=2088).

### Specific information regarding appliances with R290 refrigerant gas

- Thoroughly read all of the warnings.
- When defrosting and cleaning the appliance, do not use any tools other than those recommended by the manufacturing company.
- The appliance must be placed in an area without any continuous sources of ignition (for example: open flames, gas or electrical appliances in operation).
- Do not puncture and do not burn.
- Refrigerant gases can be odourless.
- The appliance must be installed, used and stored in an area that is greater than 15 m<sup>2</sup>.
- This appliance contains 270 g of R290 refrigerant gas.
- R290 is a refrigerant gas that complies with the European directives on the environment. Do not puncture any part of the refrigerant circuit.
- If the appliance is installed, operated or stored in a non-ventilated area, the room must be designed to prevent the accumulation of refrigerant leaks resulting in a risk of fire or explosion due to ignition of the refrigerant caused by electric heaters, stoves, or other sources of ignition.
- The appliance must be stored in such a way as to prevent mechanical failure.
- Individuals who operate or work on the refrigerant circuit must have the appropriate certification issued by an accredited organisation that ensures competence in handling refrigerants according to a specific evaluation recognized by associations in the industry.
- Repairs must be performed based on the recommendations from the manufacturing company.  
Maintenance and repairs that require the assistance of other qualified personnel must be performed under the supervision of an individual specified in the use of flammable refrigerants.

## WARRANTY AND TECHNICAL ASSISTANCE

Warranty and technical assistance conditions are indicated in the documentation provided with your appliance.

### TECHNICAL DATA

Power supply	See characteristic plate
Max absorbed power in air conditioning	"
Refrigerant	"
Cooling capacity	"
<b>Limit operating conditions:</b>	
Temperature in the room being cooled	21 ÷ 35°C

### Disposal of the appliance

 In compliance with European directive 2002/96/EC, the appliance must not be disposed of with household waste but taken to an authorised waste separation and recycling centre.

### Electrical Connection

Before plugging into the mains, check the following:

- the mains voltage is the same as that indicated on the plate on the back of the appliance;
- the socket and electrical line are sized to support the load required;
- the socket is the proper type for the plug, otherwise, replace the socket;
- the socket is connected to an efficient earthing system. The manufacturer is not responsible in the event of non-compliance with these injury prevention standards.
- **The power cable must only be replaced by specialised technicians.**

Below you will find all the information necessary for operating your air conditioner.

The appliance must be placed where there are no obstacles to air intake and output.

## DESCRIPTION

### Description of the appliance (See page 3 - A)

- A1** Air outlet grille
- A2** Control panel
- A3** Handles
- A4** Wheels
- A5** Filter
- A6** Air intake grille
- A7** Air exhaust hose housing
- A8** Air intake grille

- A9** Power supply cable
- A10** Drainage hose with 2 caps
- A11** Remote control signal receiver

**Description of accessories (See page 3 - B)**

- B1** Wall flange with cap
- B2** Air exhaust hose
- B3** Hose adapter (2 pieces)
- B4** Wall mounting accessory
- B5** Crosspiece grille
- B6** Cap for crosspiece hole
- B7** Crosspiece
- B8** Screws
- B9** Window outlet
- B10** Remote control

**AIR CONDITIONING WITHOUT INSTALLATION**

Just a few simple steps and your air conditioner will ensure your comfort:

- Screw a hose adapter **B3** to one end of the air exhaust hose **B2**.
- Fit the other adapter **B3** in the air exhaust hose housing **A7** on the back of the appliance (see fig. 1).
- Screw the end of the hose without an adaptor to the adaptor previously attached to the appliance (see fig. 1).

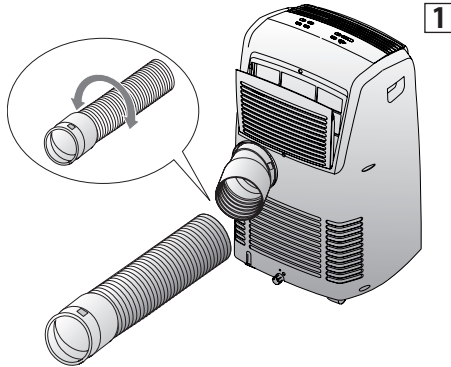

**Sash window**

- Fit the crosspiece grille **B5** to the crosspiece **B7** and attach it using the 4 screws provided **B8** (fig. 2).

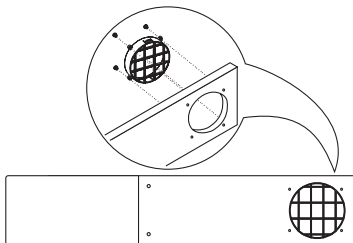

- Open the window.
- Put the crosspiece **B7** in the window, extending it the entire width of the window (fig. 3).
- Once the crosspiece has been extended, it can be attached by screwing in the remaining two screws provided.
- Lower the window (fig. 4).

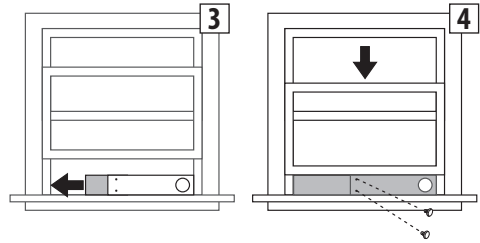

- Set the air conditioner near the window. Insert the air exhaust hose **B2** previously assembled in the grille on the crosspiece **B7** (fig. 5). Make sure the air exhaust hose is not obstructed.
- When not using the appliance, the crosspiece hole can be covered with the cap **B6** provided.

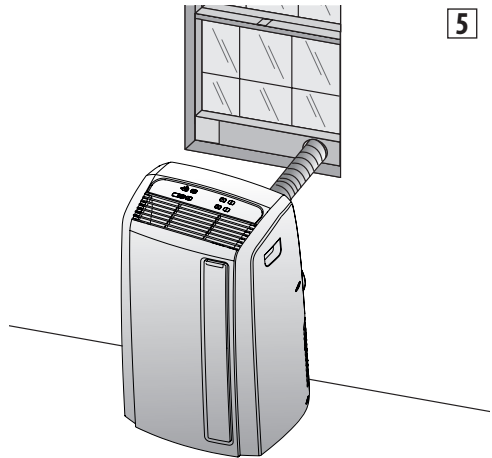

**Double casement window**

- Apply the window outlet **B9** to the air exhaust hose **B2** that was previously assembled, as shown in fig. 6.

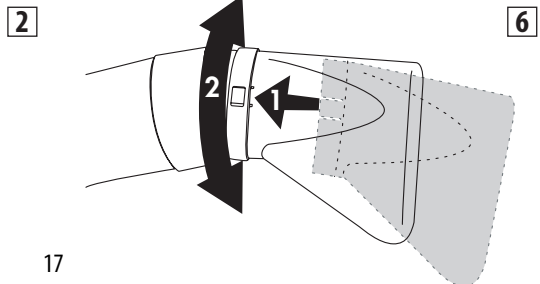

- Open the window or French door slightly and set the outlet **B9** in place as shown in figure 7.

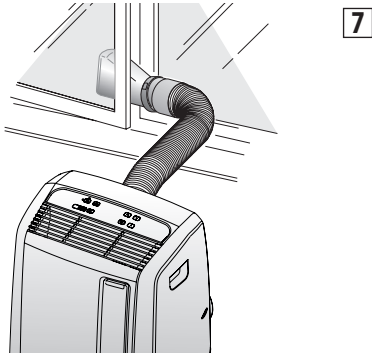

**Limit the length and curves of the air hose as much as possible, avoiding any obstruction.**

### AIR CONDITIONING WITH INSTALLATION

If desired, your appliance can also be installed semi-permanently (Fig.8), following the distances shown in the figure.

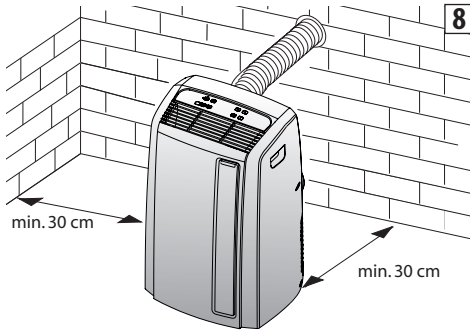

In this case, the following steps are necessary:

- Drill a hole (134 mm diam.) in an outside wall or through the glass in a window. Follow the height (see fig. 11) and sizes of the hole indicated in figure 9.

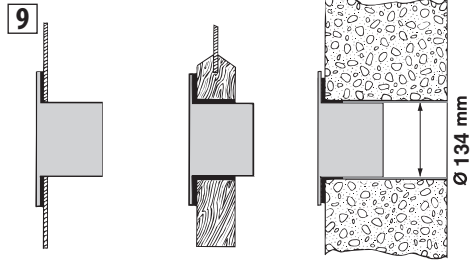

in the window  
glass

in the wood  
base of the  
French door

in the wall: we  
r e c o m m e n d  
i n s u l a t i n g  
t h e  
s e c t i o n  
o f t h e  
w a l l  
w i t h  
a  
s u i t a b l e  
i n s u l a t i o n  
m a t e r i a l

**Limit the length and curves of the air hose as much as possible, avoiding any obstruction.**

- Attach the flange accessory **B1** provided to the hole.
- Fit the adapter **B3** in the air exhaust hose housing **A7** on the back of the appliance (see fig. 1).
- Screw the wall mounting accessory **B4** on the air exhaust hose **B2**. If necessary, remove the other adapter **B3** from the air exhaust hose **B2** by unscrewing it (fig. 10).
- Screw the hose on the machine.

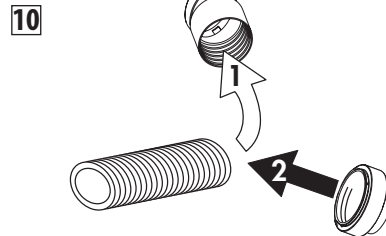

- Fit the end of the hose **B2** to the flange **B1** as shown in fig. 11.

Whenever the hose **B2** is not attached, the hole can be closed using the cap for the flange **B1**.

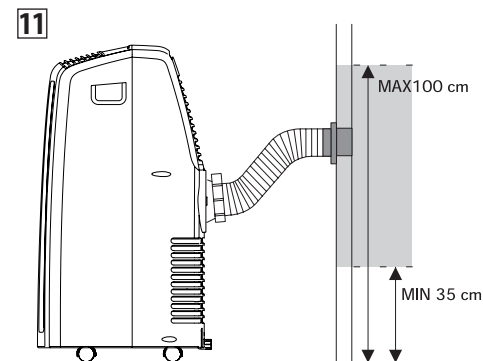

**NOTE:** for semi-permanent installations, we recommend leaving a door slightly open (even just 1 cm) to ensure the proper air exchange.

## CONTROL PANEL

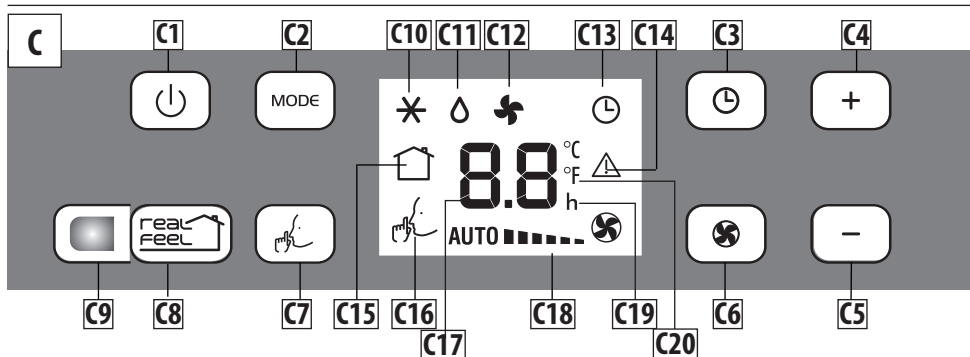

### CONTROL PANEL DESCRIPTIONS (C)

- C1** ON/STAND-BY (on/off) key
- C2** Function selection key **MODE** (air conditioner, dehumidifier, fan)
- C3** Timer key
- C4** Temperature increase/programmed operation time key
- C5** Temperature decrease/programmed operation time key
- C6** Fan speed selection key (MIN/MED/MAX/AUTO)
- C7** SILENT function selection key
- C8** REAL FEEL function selection key (optimal environmental conditions)
- C9** REAL FEEL status indicator
- C10** Air conditioner symbol
- C11** Dehumidifier symbol
- C12** Fan symbol
- C13** Timer symbol
- C14** Alarm symbol
- C15** REAL FEEL symbol (optimal environmental conditions)

- C16** SILENT symbol
- C17** Set temperature values, programmed on/off time
- C18** Fan speed indicator
- C19** Timer indicator
- C20** Selected temperature scale indicator

**Note:** The control panel keys are backlit. For each function, only the keys that can be used are lit. After the keypad has been unused for a few seconds, the panel lighting dims automatically and dims further as the minutes pass.

## CONTROL PANEL OPERATION

### TURNING THE APPLIANCE ON AND OFF



Insert the plug in the socket. Two dashes appear on the display indicating that the appliance is in stand-by and the and keys light up.

Touch the (C1) key to turn on the appliance.

When the appliance comes on, the last function set before it was shut off is activated.

**Note:** If start-up is not continued, after a few minutes the and keys go off and the display light dims in order to reduce energy consumption.

To turn the appliance off, touch the key and then pull the plug.

**NOTE:** Never turn off the air conditioner by simply pulling the plug. Touch the key and wait a few minutes before pulling the plug. In this manner, the appliance can perform the operating status checks.

### FUNCTION



REAL FEEL is a De'Longhi technology that checks the relative humidity and regulates the temperature at the same time. These are the two most important elements for comfort.

Compare to traditional air conditioning, REAL FEEL maintains comfort conditions over time, automatically modulating the compressor and fan speed.

To activate the function, touch the key.

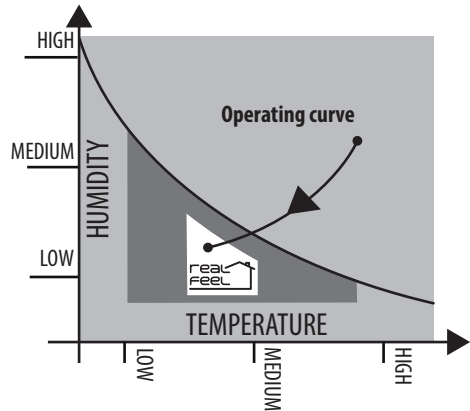

The "REAL FEEL" status indicator (C9) changes colour as it approaches comfort conditions (see graph below).

**ORANGE LIGHT:** Environmental conditions differ significantly from comfort conditions

**GREEN LIGHT:** Environmental conditions satisfactory for most people, almost perfect.

**BLUE LIGHT:** Perfect environmental conditions  
**Perfect!**

- Comfort is subjective. Consequently, different individuals can judge the same environmental conditions differently.
- In particularly severe environmental conditions (large room size, high outdoor temperature or humidity, little room insulation, many people or large thermal loads in the room, exposure to the sun, etc.), the appliance may not be able to reach comfort conditions.

### AIR CONDITIONER MODE

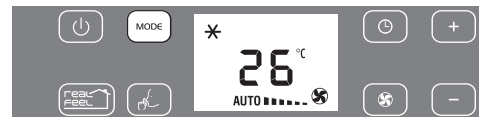

This is ideal for hot and humid weather when the room needs to be both cooled and dehumidified.

To correctly set this mode:

- Touch the **MODE** key until the air conditioning symbol appears. The display will show the desired temperature.
- To change the temperature to be reached, touch the + (C4) key or the - (C5) key.
- Select the desired fan speed by touching the key.

The speeds available are:

--- **Minimum speed:** when maximum silent operation is desired.

---- **Medium speed:** when the noise level needs to be low but with a good comfort level.

----- **Maximum speed:** to reach the desired temperature as soon as possible.

**AUTO** ----- The appliance automatically chooses the best fan speed based on the temperature selected and the environmental conditions.

*The most suitable temperatures during the summer range from 24 to 27°C. However, setting the temperature significantly lower than the outdoor temperature is not recommended.*

### **SILENT FUNCTION (CAN ONLY BE ACTIVATED IN AIR CONDITIONER MODE)**

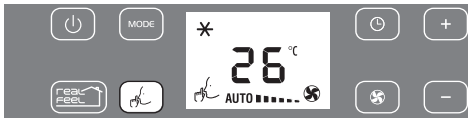

By activating this function in air conditioner mode, the noise level of the appliance is further reduced.

To activate, touch the (C7) key.

The display shows the related indicator light (C16).

### **DEHUMIDIFIER MODE**

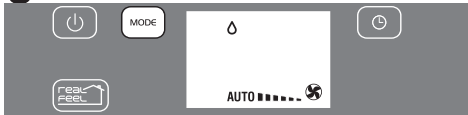

This is ideal for reducing humidity in the room (spring and autumn, damp rooms, rainy periods, etc.) For this type of use, the appliance must be set up as for air conditioner mode. That is, the air exhaust hose (B2) must be fitted to the appliance to allow the humidity to be discharged outside.

To correctly set this mode:

- Touch the **MODE** key until the dehumidifier symbol appears.

### **FAN MODE**



When using this mode, the air exhaust hose (B2) does not need to be attached to the appliance.

To correctly set this mode:

- Touch the **MODE** key until the fan symbol appears.
- Select the desired fan speed by touching the key.

The speeds available are:

--- **Minimum speed:** when maximum silent operation is desired.

---- **Medium speed:** when the noise level needs to be low but with a good fan level.

----- **Maximum speed:** for maximum fan power.

### **SELECT THE TEMPERATURE SCALE**



The temperature can be displayed in °C or °F.

To change the temperature unit of measure, exit the operating mode by pressing the key and hold down the **MODE** key for about 20 seconds. The appliance will beep.

### **PROGRAMMING THE TIMER**



The timer allows for the delayed start up or shut down of the appliance. This function will prevent wasting electricity by optimising the operating periods.

#### **How to program delayed start up**

- Plug in the appliance and set to standby.
- Touch the timer key (C3). The timer symbol (C13) and hours light up.
- Use the + (C4) or - (C5) key to set the number of hours until the appliance should start up.
- The appliance will start to operate in the same operating mode that was previously set.

Start up can be programmed at any time within the 24 hours that follow. A few seconds after the timer is set, the setting is acquired. The timer symbol stays lit and the display returns to standby.

To cancel the timer program, touch the timer key (C3) twice. The timer symbol (C13) will go off.

#### **How to program delayed shut down.**

- While the appliance is on in any operating mode, delayed shut down can be programmed.
- Touch the timer key (C3). The timer symbol (C13) and hours light up.

- Use the + (C4) or - (C5) key to set the number of hours until the appliance should shut down.

A few seconds after the timer is set, the setting is acquired, the display shows the operating mode and the timer symbol stays lit.

At the pre-set time, the air conditioner goes into Standby. To cancel the timer program, touch the timer key (C3) twice. The timer symbol (C13) will go off.

### OPERATION USING THE REMOTE CONTROL

- Aim the remote control at the receiver (A11) on the air conditioner. The maximum distance between the remote control and the appliance is 5 metres (with no obstacles between the remote and the receiver).
- The remote control should be handled with extreme care, without dropping it or exposing it to direct sunlight and keeping it away from heat sources.

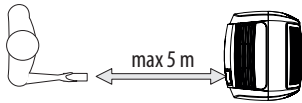

### DESCRIPTION OF THE REMOTE CONTROL (D)

- D1) "ON/STAND-BY" button
- D2) Temperature increase/decrease / programmed operation button
- D3) "MODE" button
- D4) Fan speed selection button (  )
- D5) REAL FEEL selection button
- D6) SILENT operation button
- D7) °C/°F selection button
- D8) TIMER button

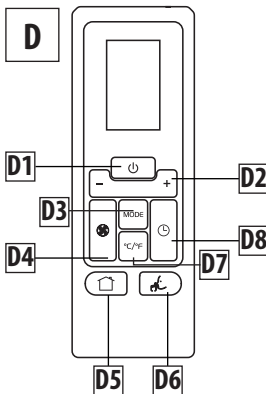



### INSERTING OR REPLACING BATTERIES

- Remove the cover on the back of the remote
- Insert two LR03 "AAA" 1.5 V batteries in the proper position (see the indications inside the battery compartment). If the batteries are low, replace them with the same type.
- Replace the cover.

**When replacing or disposing of the remote control, the batteries must be removed and disposed of according to current legislation as they are damaging to the environment. Do not mix alkaline batteries, standard (zinc-carbon) batteries or rechargeable (nickel cadmium) batteries. Do not throw the batteries in the fire as they could explode or release hazardous liquids.**

### TURNING THE APPLIANCE ON AND OFF

- Insert the plug in the socket.
- Press the  (D1) button on the remote control (when the air conditioner is turned on, the last function set before it was shut down will start).
- To turn the appliance off, press the  (D1) button on the remote control then pull the plug.

**NOTE:** Never turn off the air conditioner by only pulling the plug. Press the  key and wait a few minutes before pulling the plug. In this manner, the appliance can perform the operating status checks.



### SELECTING THE OPERATING MODES

The commands available on the remote control correspond to those on the appliance control panel (C). Therefore, refer to the instructions in the previous chapters. The D7 button, on the other hand, allows the temperature scale to be easily changed from °C to °F and vice versa.



## SELF-DIAGNOSIS

The appliance has a self-diagnosis system that identifies some operating errors. The error messages appear on the appliance display.

IF THE FOLLOWING APPEARS ON THE DISPLAY...	IF THE FOLLOWING APPEARS ON THE DISPLAY...	IF THE FOLLOWING APPEARS ON THE DISPLAY...
 <p data-bbox="219 466 367 517">"Low Temperature" (Antifreeze)</p> <p data-bbox="200 551 385 577"><b>... DO THE FOLLOWING</b></p> <p data-bbox="139 585 447 722">The appliance has a defrosting device that prevents excessive ice build ups. The appliance automatically starts operating again once the defrosting process is complete.</p>	 <p data-bbox="545 466 681 517">"Probe Failure" (Probe damaged)</p> <p data-bbox="527 551 712 577"><b>... DO THE FOLLOWING</b></p> <p data-bbox="465 585 773 637">If this appears, consult the nearest authorised service centre.</p>	 <p data-bbox="866 466 1001 517">"High Level" (Inner tray full)</p> <p data-bbox="847 551 1032 577"><b>... DO THE FOLLOWING</b></p> <p data-bbox="786 585 1094 722">Empty the inner safety tray by following the instructions in the paragraph "END OF SEASON OPERATIONS". If the error occurs again, consult the nearest authorised service centre.</p>

## TIPS

There are some recommendations to follow to achieve maximum air conditioner performance:

- close the windows and doors in the room to be cooled. The only exception is in the event of installation through a hole in the wall. In this case, it is recommended to leave a small opening through a door or window in order to ensure the proper air exchange.

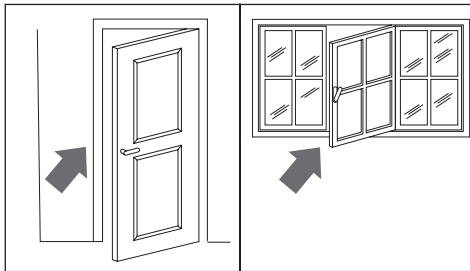

Close doors and windows

- Do not use the appliance in areas with a high degree of humidity (laundries for example).
- Protect the room from direct sunlight by pulling the drapes and/or partially closing the shutters for extremely economical operation.

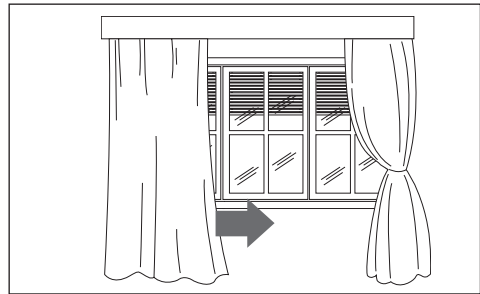

Close shutters or drapes

- Do not use the appliance outdoors.
- Make sure there are no heat sources in the room.
- Make sure the air conditioner is level on the floor.

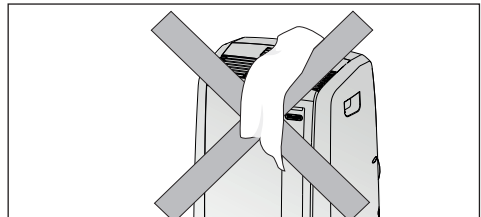

Do not cover

- Do not place objects on the air conditioner.
- Do not obstruct the air intakes.

## CLEANING

Before every cleaning or maintenance operation, shut down the appliance using the  key. Then pull the plug.

### CLEANING THE APPLIANCE

We suggest cleaning the appliance with a damp cloth and then drying it. For safety reasons, do not wash the air conditioner with water.

#### Precautions

Do not use gasoline, alcohol or solvents for cleaning. Do not spray liquid insecticides or similar substances.

### CLEANING THE AIR FILTER

To maintain the efficiency of the air conditioner, it is recommended to clean the dust filter after every week of use. The filter is located near the intake grille and the grille is located on the filter housing.

To clean the filter, it must be removed as shown in figure 12.

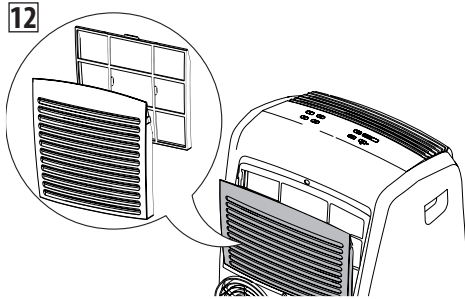

Use a vacuum cleaner to remove any dust. If it is very dirty, submerge it in warm water and rinse it several times. The water temperature must be kept below 40° C.

After washing the filter, allow it to dry.

To replace, put the filter back in its housing.

### CHECKS AT THE START OF THE SEASON

Make sure the power cable and socket are in perfect condition and make sure the earthing system is efficient. Comply strictly with the installation standards.

### END OF SEASON OPERATIONS

To completely drain the water from the internal circuit, remove the cap from the outside of the drainage hose, turning it counter clockwise. Then remove the internal cap (figure 13).

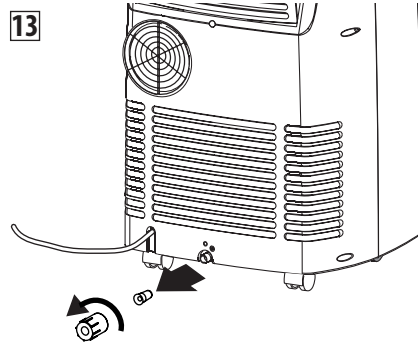

Drain the water completely into a basin. When it is completely drained, replace the caps, making sure they are completely closed.

Clean the filter as indicated previously. The filter must be completely dry before reinserting it.

**Transporting, loading, cleaning, recovery and disposal of the refrigerant must only be performed by technical service centres authorised by the manufacturing company. The appliance must only be disposed of by specialised personnel authorised by the manufacturing company.**

## TROUBLESHOOTING

Check the following points before calling the authorised Technical Service Centre in your area.

PROBLEMS	CAUSES	SOLUTIONS
The air conditioner does not turn on	it is not plugged in	plug it in
	there is no power	wait
	the internal protection device was triggered	call the help centre
The air conditioner works for a short period of time	the air exhaust hose is obstructed or bent	correctly position the air exhaust hose, limiting the length and curves as much as possible and avoiding any obstructions
	an obstruction is impeding air exhaust outside	identify and remove the obstacles that impede air exhaust outside
The air conditioner runs but does not cool the room	windows, doors, drapes open	close the windows, doors and drapes, keeping in mind the "recommendations for proper use"
	there is some heat source in the room (oven, hair dryer, etc.)	eliminate the heat source
	the air exhaust hose is disconnected from the appliance	attach the air exhaust hose to the housing on the back of the appliance (fig.1)
	dust filters clogged	clean or replace the filters as previously described
	the technical characteristics of the appliance are not suitable for cooling the room where it is located	
During operation there is an unpleasant odour in the room	dust filters clogged	clean or replace the filters as previously described
The air conditioner does not work for about 3 minutes from restart	to protect the compressor there is an internal device that delays startup for about 3 minutes from restart	wait; this time delay from restart is normal
The display shows the  symbol with one of the following messages: <i>HL/PF</i>	The appliance has a self-diagnosis system that identifies some operating errors.	refer to the SELF-DIAGNOSIS chapter