

# Important safeguard

- Use this appliance only as described in this instruction manual.

As with any electrical appliance, the instructions aim to cover as many situations as possible. Caution and common sense should be used when operating and installing this air conditioner.

- This appliance has been manufactured to cool and dehumidify domestic environments and must not be used for other purposes.
- It is dangerous to alter or modify the unit's characteristics in any way.
- The appliance must be installed in accordance with the relevant national legislation.
- Should repairs be necessary, contact the nearest authorized Repair Service Center. Unauthorized servicing can be dangerous.
- The appliance is not intended for use by persons (including children) with reduced physical, sensory or mental capabilities, or lack of experience and knowledge, unless they have been given supervision or instruction concerning use of the appliance by a person responsible for their safety.  
Children should be supervised to ensure that they do not play with the appliance.
- If the power cable is damaged, it must be replaced by the manufacturer or an authorized technical service centre in order to avoid all risk.
- Always ensure the appliance is plugged into a grounded 3-prong outlet. If you have any doubts check with a qualified electrician.
- Do not use extension cables.
- Before cleaning or maintenance operations, always unplug the unit from the outlet.
- Do not pull on or place strain on the power cord when moving the appliance.
- The appliance should not be installed where the atmosphere may contain combustible gases, oil or sulphur, or near heat sources.
- Do not rest hot or heavy objects on the appliance.
- Clean the filters at least once a week.
- Avoid using heaters near the unit.

- The unit should be transported in a vertical position. If this is not possible secure the unit at an angle, do not lie it horizontally.
- Before transporting the unit, drain the unit. After transportation, wait at least 6 hours before switching the unit on.
- The packaging materials can be recycled. You are therefore recommended to place them in the special containers for differentiated waste collection.
- This appliance is fitted with a special safety device. When the compressor switches off, this device prevents it from switching on again for at least 3 minutes.
- **WARNING:** Changes or modifications not expressly approved by the party responsible for compliance could void the user's authority to operate the equipment.

## Specific warnings for appliances with R410A refrigerant gas

R410A refrigerant gas conforms to EC regulations on the environment.

Avoid perforating the refrigerant circuit of the appliance.

## ENVIRONMENTAL INFORMATION:

This unit contains fluorinated greenhouse gases covered by the Kyoto Protocol.

Maintenance and disposal must be carried out by qualified personnel only (R410A, GWP=1975).

# Save these instructions

## This product is for household only

## INTRODUCTION

Thank you for choosing a De'Longhi product. Please take a few moments to read the instructions to avoid risks or damage to the appliance.

## DESCRIPTION

**Description of the appliance (see page 3 - Fig. A)**

- A1** air outlet grille
- A2** control panel
- A3** handles
- A4** castor wheels
- A5** BioSilver filter
- A6** air intake grille
- A7** air exhaust hose housing
- A8** air intake grille
- A9** power cable
- A10** drainage hose with cap
- A11** remote control signal receiver
- A12** remote control compartment

**Description of the accessories (see page 3 - Fig. B)**

- B1** wall flange with cap
- B2** assembled air exhaust hose
- B3** window outlet
- B4** window bracket with pins
- B5** additional window bracket with pins
- B6** water drain hose with cap
- B7** remote control
- B8** end of season dust cover
- B9** end of season accessories bag

### Electrical connection

Before plugging the appliance into the electrical receptacle, check that:

- The outlet's power supply corresponds to the value indicated on the rating label on the back of the appliance;
- The outlet and electrical circuit are adequate for the appliance;
- The outlet is a 3-hole grounded outlet (⏏). If this is not the case, you must choose another outlet. Failure to follow these important safety instructions absolves the manufacturer of all liability.

**If it becomes necessary, the power cable must be replaced by a qualified professional only.**

The instructions below will enable you to prepare your air conditioner for operation as efficiently as possible. Before use, make sure the air intake and outlet grilles are unobstructed.

## USE

### AIR CONDITIONING WITHOUT INSTALLATION

**For optimal results set-up in a double-hung window:**

- 1) Place the bracket in the window sill, extend the bracket fully within the window frame, fix the bracket by using the pin then lower the window onto the bracket. (Should the window bracket be too large for the window. The plastic can be cut with a saw by a qualified professional.)
- 2) Fit the air exhaust hose **B2** in the housing at the back of the appliance. Insert it as shown in figure 1.

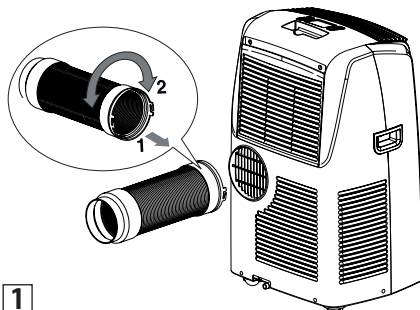

- 3) Connect the window outlet **B3** to the other end of the exhaust hose.
- 4) Insert the window outlet end of the exhaust hose into the slot of the window bracket (fig. 2).



### Other set-up methods:

- Thanks to the locking pins, it's possible to use the window bracket also for sliding windows. Position the hole of the bracket so to allow a correct installation of the exhaust hose (see figure 3).

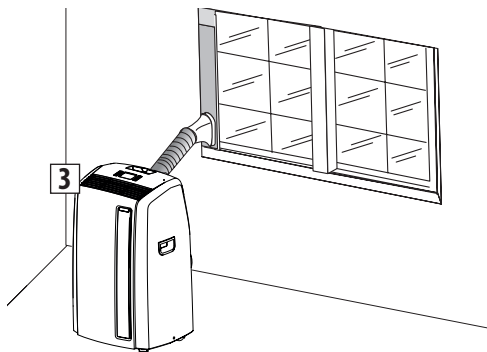

- If you have a casement window (figure 4) follow steps 2 & 3 and place the window outlet **B3** outside the window to exhaust the hot air.

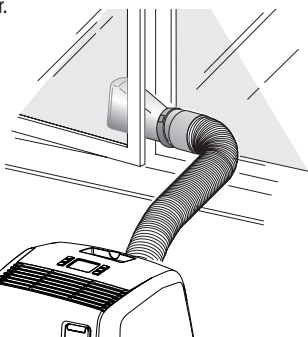

4

- If the windows are large, use the additional window bracket **B5** (if provided) to cover your window aperture, extending it to the required length, then blocking it with the locking pins supplied (see figure 5). Make sure you do not cover the hole for the window outlet.

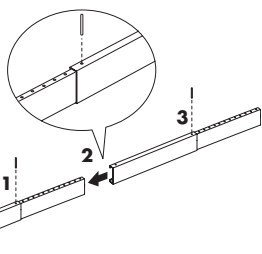

5

For help with installation, operation, and for all accessories and spare/replacement parts, please contact our toll free customer service call center at:

**1-800-322-3848** [US only]

**1-888-335-6644** [Canada only]

**01-800-711-8805** (Mexico only)

or log onto our website at [www.delonghi.com](http://www.delonghi.com)

## SEMI-PERMANENT INSTALLATION

If required, your appliance can also be installed semi-permanently (fig. 6).

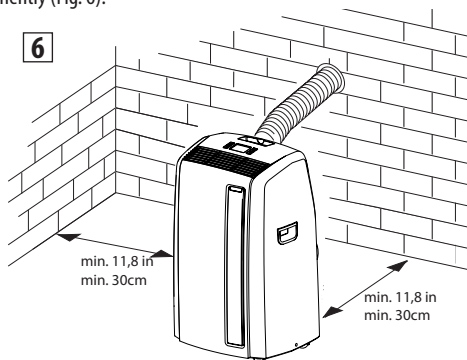

6

Proceed as follows:

- Drill a hole  $\varnothing 5,25$  inches (134 mm) in an outside wall or through a window pane. Respect the dimensions and height of the hole given in figure 7 and 8.

7

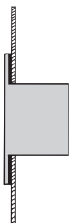

in the window panel



in the wooden kickboard of a French window

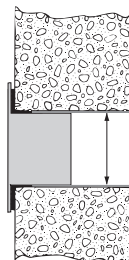

in the wall: you are recommended to insulate the section of wall using suitable insulation.

- Fit the wall flange **B1** into the hole.
- Fit the air exhaust hose **B2** in the relevant housing located on the rear side of the appliance. (fig. 1).
- Fit the end of the hose **B2** to the wall flange **B1** as shown in fig. 8.
- When the hose **B2** is not connected, the drilled hole can be closed with the flange cap **B1**.

8

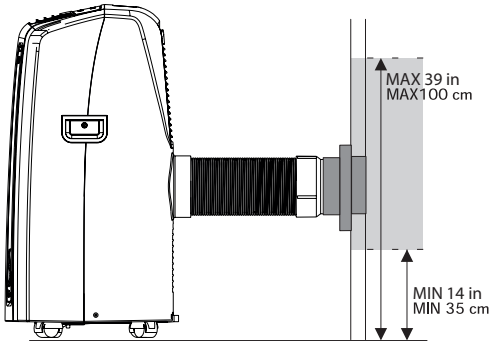

**NOTE:** As special tools are required for installation, we suggest you have the appliance installed by specialized personnel.

**NOTE:** When installing the air conditioner semi-permanently, you should leave a door slightly open little as 1/2" (1 cm) to guarantee correct ventilation and room pressure.

**NOTE:** Keep the air hoses as short and free of curves as possible to avoid constrictions.

## CONTROL PANEL

C

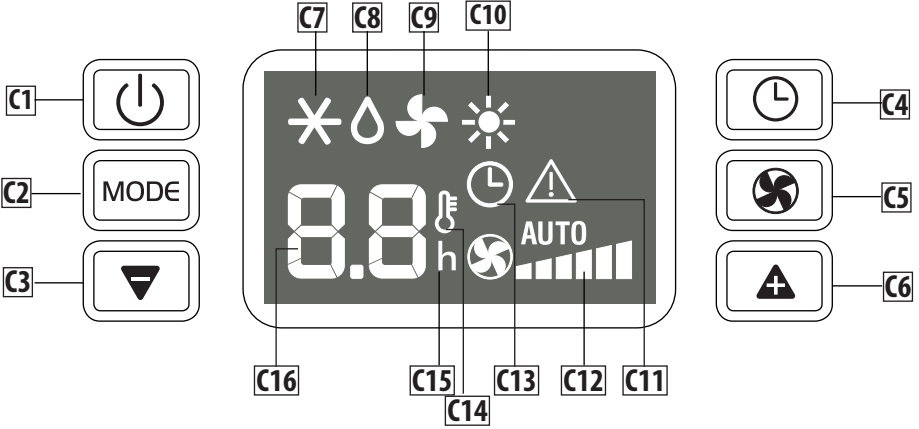

### DESCRIPTION OF THE CONTROL PANEL ( Fig. C)

- C1** ON/STAND-BY button
- C2** **MODE** selection button (conditioning, dehumidifying, fan, heating)
- C3** Decrease temperature/programmed operation time button
- C4** Timer button
- C5** Fan speed selection button (LOW/MED/HIGH/AUTO)
- C6** Increase temperature/programmed operation time button
- C7** Air-conditioning symbol
- C8** Dehumidifying symbol
- C9** Fan symbol
- C10** Heating symbol

- C11** Alarm symbol
- C12** Fan speed indicator
- C13** Timer symbol
- C14** Set temperature symbol
- C15** Time indicator
- C16** Temperature value set, programmed delayed ON/OFF time

**Note:**  
After few seconds of the control panel inactivity, its brightness will be automatically reduced.  
When in stand-by after few minutes it will be further reduced.

## OPERATING FROM THE CONTROL PANEL

### TURNING THE APPLIANCE ON/OFF



**Before plugging the appliance check the cap on back of the unit are correctly inserted on drainage hose A10.**

Plug the appliance into the electrical receptacle. Two lines appear on the display indicating that the appliance is in stand-by. Press  button (C1) to switch the appliance on. When turned on, the air conditioner starts operating in the same mode as when it was turned off.

To turn off the appliance, press the  button, then unplug the appliance.

**Note:** Never switch off the appliance by unplugging it: always press the  button, wait a few minutes and then unplug. Doing so, the appliance will run a check of the operating conditions.



### AIR CONDITIONING MODE





Ideal for hot muggy weather when you need to cool and dehumidify the room. To set this mode:

- Press repeatedly the **MODE** button (C2) until the conditioning symbol is displayed: the display shows the desired temperature.
- Press + (C6) or - (C3) buttons to adjust the desired temperature.
- Select the fan speed by pressing the  button (C5).

You can choose:

-  **Minimum speed:** for silent operation.
-  **Medium speed:** reduces noise levels while maintaining a comfortable temperature.

•  **Maximum speed:** to achieve the target temperature as rapidly as possible.

**AUTO**  the appliance automatically selects the most suitable fan speed in relation to the temperature set on the digital display and current room temperature.

*The most suitable indoor temperature for the room during the summer varies from 75°F to 81°F (24 to 27°C). You are recommended, however, not to set a temperature much below the outdoor temperature.*

### DEHUMIDIFYING MODE



Ideal to reduce room humidity (spring and autumn, damp rooms, rainy periods, etc). In dehumidifying mode, the appliance **MUST** be set-up in the same way as for air conditioning, with the air exhaust hose (B2) attached to enable the moisture to be discharged outside. To set this mode:

- Press repeatedly the **MODE** button until the dehumidifying symbol is displayed.

### FAN MODE

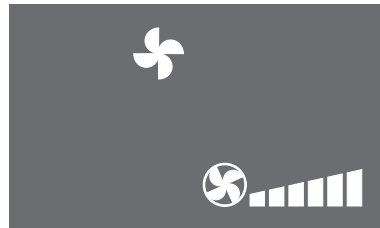



When using the appliance in this mode, the air exhaust hose (B2) does not need to be connected.

To set this mode:

- Press repeatedly the **MODE** button until the fan symbol is displayed.
- Select the fan speed by pressing the  button (C5).

You can choose:

-  **Minimum speed:** for silent operation.
-  **Medium speed:** reduces noise levels but still maintains a good level of comfort.

Maximum speed: for maximum fan power.

## HEATING MODE

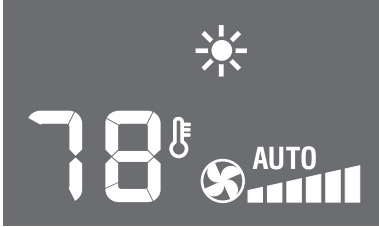

This is ideal in spring and autumn when outdoor temperatures are not particularly severe. For this mode, the appliance should be prepared in the same way as for air conditioning, with the air exhaust hose (B2) attached to enable the moisture to be discharged outside. To set this mode:

- Press repeatedly the **MODE** button until the heating symbol is displayed.
- Press + (C3) or - (C6) buttons to adjust the desired temperature.

### Note:

- In this mode, fan speed is selected automatically by the appliance and cannot be set manually.
- When operating in very cold rooms, the appliance defreezes automatically, momentarily interrupting normal operation. "Lt" appears on the display. During this operation, it is normal for the noise made by the appliance to change.
- In this mode, you may have to wait a few minutes before the appliance starts giving out hot air.
- In this mode, the fan may operate for short periods, even though the set temperature has already been reached.
- It may happen that the display shows "HL" alarm. In this case, empty the internal safety tank following the instruction in the Section "End of Season operators". At the end, press again the  button to restore the heating function.

## SETTING THE TIMER



The timer can be used to delay appliance start up or shutdown. This avoids wasting electricity by not operating the appliance when it is not needed.

### How to program delayed start up

- Plug the appliance into the electrical receptacle and turn the unit to standby.
- Press the timer button (C4): the timer symbol (C13) and the number of hours come on.
- Use the + (C6) or - (C3) buttons to set the number of hours delay before the appliance comes on.
- A few second after set, the setting is memorised, the timer symbol is lit and the display shows that the appliance is in standby.
- The appliance will start working using the mode previously set. The appliance can be set to come on within the next 24 hours.

To delete the setting, press two times the timer button (C4). The timer symbol (C13) switches off.

### How to program delayed shutdown

- With the air conditioner on, in every mode, it is possible to set the delayed shutdown.
- Press the Timer (C4) button: the timer symbol (C13) and the hours switch on.
- Use the + (C6) or - (C3) buttons to set the number of hours delay before the appliance turns off. A few second after set, the setting is memorised, the timer symbol is lit and the display shows the current mode.

At the end of the set time the appliance automatically turns in standby mode.

To delete the setting, press two times the timer button (C4). The timer symbol (C13) switches off.

## OPERATING FROM THE REMOTE CONTROL

### USING THE REMOTE CONTROL

- Point the remote control at the receiver (A11) on the air conditioner. The remote control must be no more than 16 ft (5 meters) away from the appliance (without obstacles between the remote control and the receiver).
- The remote control must be handled with extreme care. Do not drop it or expose it to direct sunlight or sources of heat.

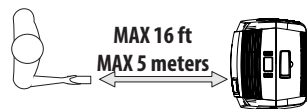

**NOTE:** The remote control can be safely stored in the appropriate compartment A12 (see figure).

## DESCRIPTION OF THE REMOTE CONTROL (FIG. D)

- D1) ON/STAND-BY button
- D2) Increase/decrease temperature/programmed operation
- D3) "MODE" selection button
- D4) Fan speed selection button
- D5) Switch button °C/°F
- D6) TIMER button

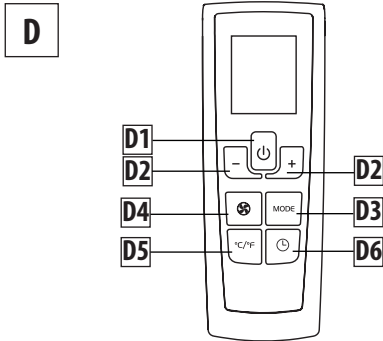



## INSERTING OR REPLACING THE BATTERIES

- Remove the cover on the rear of the remote control;
- Replace the old batteries with two new R03 "AAA" 1.5V batteries, inserting them correctly (see the instructions inside the battery compartment);
- Replace the cover.

**If the remote control unit is replaced or discarded, the batteries must be removed and disposed of in accordance with current legislation as they are harmful to the environment. Do not mix old and new batteries.**

**Do not mix alkaline, standard (carbon-zinc) or rechargeable (nickel-cadmium) batteries. Do not dispose of batteries in fire. Batteries may explode or leak. If the remote control is not be used for a certain length of time, remove the batteries.**

## TURNING THE APPLIANCE ON

- Plug into the electrical receptacle.
- Press the  button (D1) (when turned on, the air conditioner starts operating in the same mode as when it was turned off) .
- To switch the appliance off, press button  (D1), then remove the plug.

**NOTE:** Never switch the appliance off by removing the plug. Always switch it off by pushing on the  button and waiting few minutes before removing the plug. Only in this way the appliance will perform the standard checkings.

## FUNCTIONS SELECTION

The controls on the remote control are the same as those on the control panel of the appliance (C). You should therefore refer to the instructions in the chapter "OPERATING FROM THE CONTROL PANEL" to select the desired functions. Press button D5 to switch the temperature display from °C to °F and vice versa.

### Note:

- This equipment has been tested and found to comply with the limits for a Class B digital device, pursuant to part 15 of the FCC Rules. These limits are designed to provide reasonable protection against harmful interference in a residential installation.
  - This equipment generates, uses and can radiate radio frequency energy and, if not installed and used in accordance with the instructions, may cause harmful interference to radio communications. However, there is no guarantee that interference will not occur in a particular installation. If this equipment does cause harmful interference to radio or television reception, which can be determined by turning the equipment off and on, the user is encouraged to try to correct the interference by one or more of the following measures:
    - Reorient or relocate the receiving antenna.
    - Increase the separation between the equipment and receiver.
    - Connect the equipment into an outlet on a circuit different from that to which the receiver is connected.
    - Consult the dealer or an experienced radio/TV technician for help.
- Changes or modifications not expressly approved by the party responsible for compliance could void the user's authority to operate the equipment.
- This device complies with Part 15 of the FCC Rules. Operation is subject to the following two conditions: (1) this device may not cause harmful interference, and (2) this device must accept any interference received, including interference that may cause undesired operation.
  - This Class B digital apparatus complies with Canadian CAN ICES-3 (B) / NMB-3 (B).

## SELF-DIAGNOSIS

The appliance has a self diagnosis system to identify a number of malfunctions. Error messages are displayed on the appliance display.

IF ... IS DISPLAYED,	IF ... IS DISPLAYED,	IF ... IS DISPLAYED,
<div data-bbox="140 225 333 357" data-label="Image"> </div> <p data-bbox="165 379 308 432">"Low Temperature" (frost prevention)</p> <p data-bbox="146 469 327 491"><b>..WHAT SHOULD I DO?</b></p> <p data-bbox="85 497 389 635">The appliance is fitted with a frost protection device to avoid excessive formation of ice. The appliance starts up again automatically when the defrosting process is completed.</p>	<div data-bbox="461 225 655 357" data-label="Image"> </div> <p data-bbox="493 379 622 432">Probe Failure (Probe damaged)</p> <p data-bbox="468 469 648 491"><b>..WHAT SHOULD I DO?</b></p> <p data-bbox="406 497 711 550">If this is displayed, contact your local authorized service center.</p>	<div data-bbox="785 225 978 357" data-label="Image"> </div> <p data-bbox="815 379 944 432">"High Level" (Internal tray full)</p> <p data-bbox="789 469 969 491"><b>..WHAT SHOULD I DO?</b></p> <p data-bbox="726 497 1034 663">Empty the internal safety tank following the instructions in the section "End of season operations". If HL alarm reoccurs frequently in Air Conditioning, Dehumidifying or Heating mode, contact your local authorized service center.</p>

## TIPS FOR CORRECT USE

To ensure optimal results from your air conditioner, follow these recommendations:

- close the windows and doors in the room to be air conditioned. When installing the air conditioner semi-permanently, you should leave a door slightly open (as little as 1/2 inch (1 cm)) to guarantee proper ventilation.

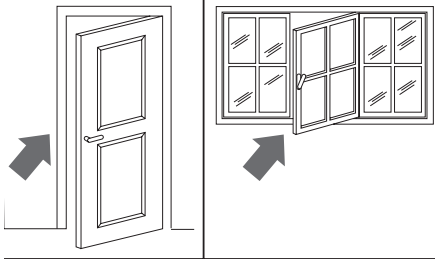

### Close doors and windows

- Never use the appliance in very damp rooms (laundries for example).
- Protect the room from direct exposure to the sun by partially closing curtains and/or blinds to make the appliance much more economical to run.

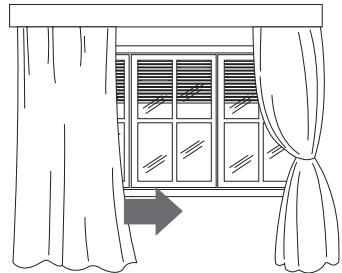

### Close blinds or curtains

- Never use the appliance outdoors.
- Make sure there are no heat sources in the room.
- make sure the air conditioner is standing on a level surface.

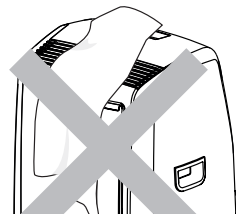

### do not cover the appliance

- Never rest objects of any kind on the air conditioner.
- Never obstruct the air intake or outlet grilles.



## CLEANING

Before cleaning or maintenance, turn the appliance off by pressing the  button, then unplug from electrical receptacle.

### CLEANING THE CABINET

You should clean the appliance with a slightly damp cloth then dry with a dry cloth. For safety reasons, never wash the air conditioner with water.

#### Precautions

Never use petrol, alcohol or solvents to clean the appliance. Never spray insecticide liquids or similar.

### CLEANING THE BIO SILVER AIR FILTER

If the filter is dirty, air circulation is compromised and the efficiency of the dehumidifying and air purifying functions decreases.

It is therefore good practice to clean the filter at regular intervals. The frequency depends on the duration and conditions of operation.

If the unit is used constantly or systematically, you are recommended to clean the filter once a week.

The filter is housed in the intake grille.

To clean the filter, extract as shown in fig. 9.

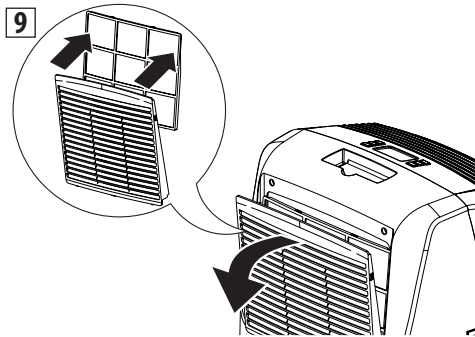

Use a vacuum cleaner to remove the dust collected on the filter. If it is very dirty, immerse in warm water and rinse a number of times. The water should never be hotter than 104°F (40°C). After washing the filter, allow it to dry completely before repositioning it.

The BioSilver filter helps capture dust and pollen and helps reduce the growth of bacteria and mold on the filter.

### START OF SEASON CHECKS

Make sure the power cable and plug are undamaged and the ground connection is efficient.

Follow the installation instructions precisely.

### END OF SEASON OPERATIONS

To drain all water from the circuit, remove the cap **A10** from the drainage on the back of the appliance and allow the water to drain out into a basin (fig. 10).

To facilitate this operation, at the start of the season, it's possible to apply the water drain hose with cap **B6**.

In order to properly storage the appliance at the end of the season, we suggest you cover it with the supplied end of season dust cover **B8** and you put the accessories in the relevant end of season accessories bag **B9**.

**10**

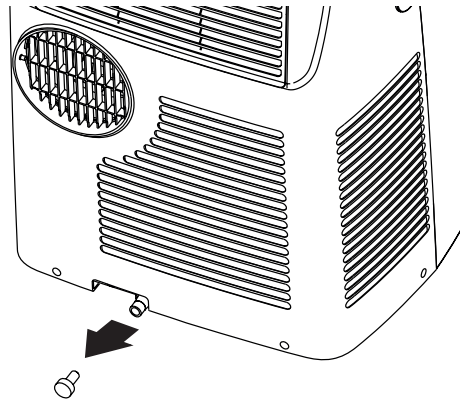

When the appliance is empty, replace the caps. Clean the filter and dry thoroughly before putting back.

### TECHNICAL SPECIFICATIONS

Power supply voltage	see rating label
Max. absorbed power during air conditioning	"
Refrigerant	"
Cooling capacity	"

### LIMIT CONDITIONS

Room temperature for air conditioning (with fans at maximum speed)	64 ÷ 104°F	18 ÷ 40°C
--	------------	-----------

**Transport, filling, cleaning, recovery and disposal of refrigerant should be performed by a technical service centre appointed by the manufacturer only.**

**The appliance should be disposed of by a specialist centre appointed by the manufacturer only.**

#### **TO AVOID DAMAGE TO THE UNIT:**

NEVER TRANSPORT OR TURN THE APPLIANCE UPSIDE DOWN OR ON ITS SIDE. IF THIS OCCURS, WAIT 6 HOURS BEFORE TURNING THE APPLIANCE ON, 24 HOURS IS RECOMMENDED. After the unit has been on its side, oil needs to return to the compressor to ensure proper function. Without allowing the unit this time (6-24 hours) the unit may function for only a short time, and then the compressor will break down from lack of oil.

#### **ELECTRICAL CONNECTION**

This appliance is equipped with a 3 prong grounded plug. The plug must be connected into an outlet that is properly installed and grounded in the accordance with all local codes and ordinances. Do not modify the plug provided with the appliance. If it will not fit the outlet, have a proper outlet installed by a qualified electrician or relocate the unit to a proper outlet. If the household electrical supply does not meet the above specifications, or if you are not sure your home has an effective electrical ground, have a qualified electrician or your local electrical utility company check it and correct any problems.

#### **SAFETY PLUG**

The appliance is fitted with a safety plug to protect the power cable.

If power is cut off, unplug from the outlet and make sure the power cable is undamaged.

If the cable is damaged, call the service center immediately.

If power cuts off frequently and the power cable is undamaged, contact a qualified electrician.

#### **OPERATION OF THE SAFETY PLUG**

If the safety device incorporated in the plug trips and cuts off the power supply, check that the power cable and plug are not damaged.

If the power cable is undamaged, to restore operation press the "RESET" button.

To verify correct operation of the plug, press the "TEST" button periodically and make sure the appliance disconnects. If this is not the case, contact the service center.

To restore operation, press the "RESET" button.

## TROUBLESHOOTING

PROBLEM	CAUSE	SOLUTION
The air conditioner does not come on	it is not plugged into the electrical receptacle	plug into the electrical receptacle
	there is no current	wait
	the internal safety device has tripped	call the Service Center
The air conditioner works for a short time only	there are bends or kinks in the air exhaust hose	position the air hose correctly, keeping it as short and free of curves as possible to avoid bottlenecks
	something is preventing the air from being discharged	check and remove any obstacles obstructing air discharge
The air conditioner works, but does not cool the room	windows, doors and/or curtains opened	close doors, windows and curtains, bearing in mind the "TIPS FOR CORRECT USE" given previously
	there are heat sources in the room (oven, hairdryer, etc)	eliminate the heat sources
	the air exhaust hose is detached from the appliance	fit the air exhaust hose in the housing at the back of the appliance (fig. 1).
	filter clogged	clean or replace the filter as previously described
	the technical specification of the appliance is not adequate for the room in which it is located.	
During operation, there is an unpleasant smell in the room	the filter is clogged	clean the filters as previously described
The air conditioner does not operate for about three minutes after restarting it	prevents the appliance from being restarted until three minutes have elapsed since it was last turned off	wait. This delay is part of normal operation.
The symbol  and one of the following messages: <i>HL/PF</i> appear on the display	the appliance has a self diagnosis system to identify a number of malfunctions.	see the SELF-DIAGNOSIS chapter

De'Longhi is the distributor of Kenwood home appliances.

**This warranty applies to all home appliances with De'Longhi or Kenwood brand names**

**LIMITED WARRANTY**

We warrant each De'Longhi AIR CONDITIONER to be free from defects in material and workmanship. From the purchase date, our obligation under this warranty is to provide two(2) year free parts and labor on the entire AIR CONDITIONER, with an additional four (4) years free on any part of the sealed system consisting of the compressor, evaporator, condenser and factory connected refrigerant tubing. Labor and all other parts during the additional four (4) year warranty are to be paid by the owner. All AIR CONDITIONERS in need of repair are to be shipped to an authorized De'Longhi service center at the owner's expense, and De'Longhi will then incur the return shipping costs. After the first six (6) years of ownership, all expenses (all parts, labor and shipping) are to be paid by the owner of the unit. This warranty shall apply only if the AIR CONDITIONER is used in accordance with the factory directions that accompany it, and on an Alternating Current (AC) circuit. This warranty is in lieu of all other warranties and representations, expressed or implied, and all other obligations or liabilities on our part. We do not authorize any other person or company to assume for us any liability in connection with the sale or use of our AIR CONDITIONER. This warranty shall not apply to any AIR CONDITIONER that has been repaired or altered outside our factory nor shall it apply to any AIR CONDITIONER that has been subjected to misuse, negligence or accidents.

If repairs become necessary, see contact information below:

**U.S. Residents:**

Please contact our toll free hotline at **1-800-322-3848**  
or log onto our website at [www.delonghi.com](http://www.delonghi.com)

**CANADA Residents:**

Please contact our toll free hotline at **1-888-335-6644**  
or log onto our website at [www.delonghi.com](http://www.delonghi.com)

**MEXICO Residents:**

Please contact our toll free hotline at **01-800-711-8805**  
or log onto our website at [www.delonghi.com](http://www.delonghi.com)

The above warranty is in lieu of all other express warranties and representations. All implied warranties are limited to the applicable warranty period set forth above. This limitation does not apply if you enter into an extended warranty with De'Longhi. Some states/countries do not allow limitations on how long an implied warranty lasts, so the above exclusions may not apply to you. De'Longhi does not authorize any other person or company to assume for it any liability in connection with the sale or use of its appliance.

**How does country law apply?**

This warranty gives you specific legal rights, and you may also have other rights, which vary from state to state/country to country.