



MADE IN CHINA / HECHO EN CHINA

5715112141\_00/11.15

[www.delonghi.com](http://www.delonghi.com)



**AIR CONDITIONER**  
INSTRUCTION MANUAL - SAVE THESE INSTRUCTIONS

**CONDITIONNEUR D'AIR PORTATIF**  
MODE D'EMPLOI - CONSERVEZ CETTE NOTICE

**AIRE ACONDICIONADO PORTÁTIL**  
INSTRUCCIONES DE USO  
CONSERVE ESTAS INSTRUCCIONES  
LEA CUIDADOSAMENTE ESTE INSTRUCTIVO ANTES DE  
USAR SU APARATO

**PAC N Serie**

Visit: [www.delonghiregistration.com](http://www.delonghiregistration.com)

Visit: [www.delonghi.com](http://www.delonghi.com) for a list of service centers near you.

Visitez: [www.delonghiregistration.com](http://www.delonghiregistration.com)

Visitez: [www.delonghi.com](http://www.delonghi.com) pour y voir une liste des centres de réparation proches de chez vous.

Visite: [www.delonghiregistration.com](http://www.delonghiregistration.com)

Visite: [www.delonghi.com](http://www.delonghi.com) para ver la lista de centros de servicios cercanos a usted.

**ELECTRICAL SPECIFICATIONS**  
**DONNEES ELECTRIQUES**  
**ESPECIFICACIONES ELECTRICAS**

115 V ~ 60 Hz 10 A



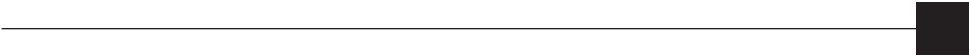

# Description - Description - Descripción

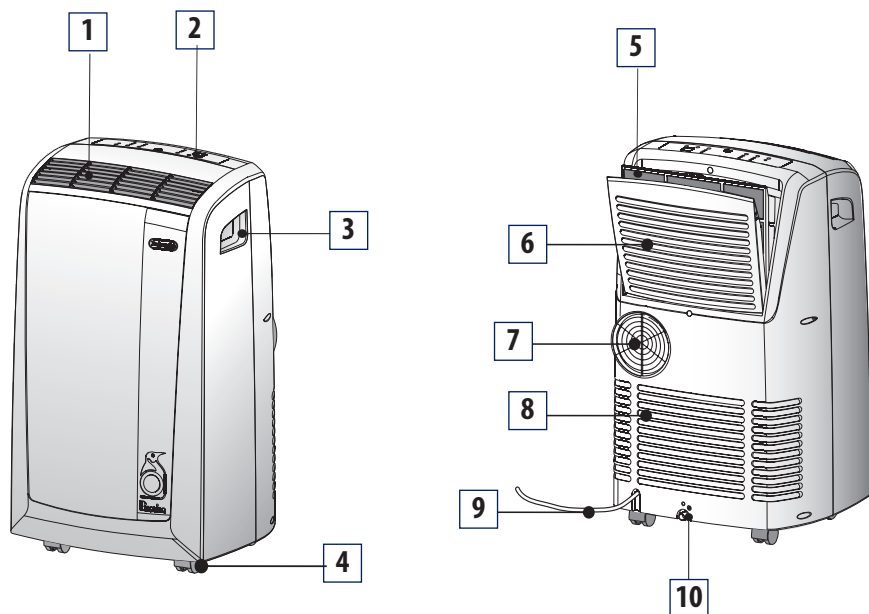

# Accessories - Accessoires - Accesorios

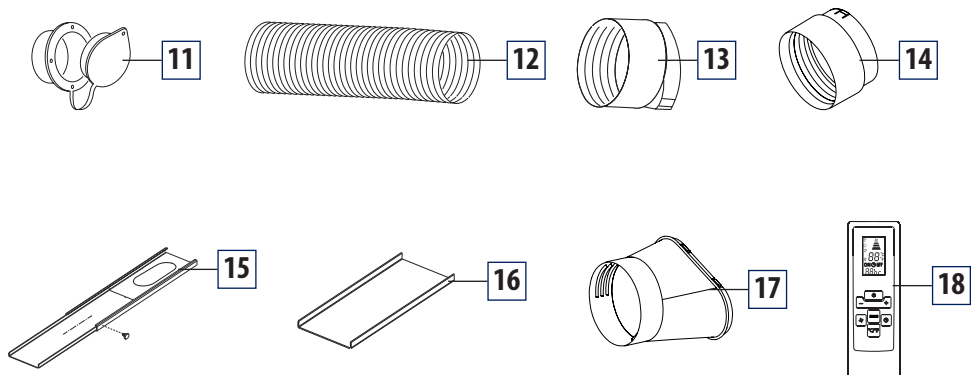

- Use this appliance only as described in this instruction manual.  
As with any electrical appliance, the instructions aim to cover as many situations as possible. Caution and common sense should be used when operating and installing this air conditioner.
- This appliance has been manufactured to cool and dehumidify domestic environments and must not be used for other purposes.
- It is dangerous to alter or modify the unit's characteristics in any way.
- The appliance must be installed in accordance with the relevant national legislation.
- Should repairs be necessary, contact the nearest authorized Repair Service Center. Unauthorized servicing can be dangerous.
- The appliance is not intended for use by persons (including children) with reduced physical, sensory or mental capabilities, or lack of experience and knowledge, unless they have been given supervision or instruction concerning use of the appliance by a person responsible for their safety.  
Children should be supervised to ensure that they do not play with the appliance.
- In the case that the power cord becomes damaged, this must be repaired only by specialized personnel authorized by the manufacturer in order to protect against fire.
- Always ensure the appliance is plugged into a grounded 3-prong outlet. If you have any doubts check with a qualified electrician.
- We strongly discourage the use of an extension cord due to potential safety hazards.
- Before cleaning or maintenance operations, always unplug the unit from the outlet.
- Do not pull on or place strain on the power cord when moving the appliance.
- The appliance should not be installed where the atmosphere may contain combustible gases, oil or sulphur, or near heat sources.
- Do not rest hot or heavy objects on the appliance.
- Clean the filters at least once a week.
- Avoid using heaters near the unit.
- The unit should be transported in a vertical position. If this is not possible secure the unit at an angle, do not lie it horizontally.
- Before transporting the unit, drain the unit. After transportation, wait at least 6 hours before switching the unit on.
- The packaging materials can be recycled. You are therefore recommended to place them in the special containers for differentiated waste collection.
- This appliance is fitted with a special safety device. When the compressor switches off, this device prevents it from switching on again for at least 3 minutes.
- **WARNING:** Changes or modifications not expressly approved by the party responsible for compliance could void the user's authority to operate the equipment.

## SAVE THESE INSTRUCTIONS THIS PRODUCT IS FOR HOUSEHOLD ONLY

### DESCRIPTION

- |   |                          |    |                             |
|---|--------------------------|----|-----------------------------|
| 1 | Air outlet grille        | 10 | Drainage hose with 2 caps   |
| 2 | Control panel            | 11 | Wall flange with cap        |
| 3 | Handles                  | 12 | Air exhaust hose            |
| 4 | Castors                  | 13 | Hose adaptor                |
| 5 | Filter                   | 14 | Accessory for wall mounting |
| 6 | Air intake grille        | 15 | Window bracket              |
| 7 | Air exhaust hose housing | 16 | Additional window bracket   |
| 8 | Air intake grille        | 17 | Window outlet               |
| 9 | Power cable              | 18 | Remote control              |

## ELECTRICAL CONNECTIONS

Before plugging the appliance into the the electrical receptacle, check that:

- The outlet's power supply corresponds to the value indicated on the rating label on the back of the appliance;
- The outlet and electrical circuit are adequate for the appliance;
- The outlet is a 3-hole grounded outlet (⚡). If this is not the case, you must choose another outlet.

**Failure to follow these important safety instructions absolves the manufacturer of all liability.**

**The power cable must be replaced by a qualified professional only.**

The instructions below will enable you to prepare your air conditioner for operation as efficiently as possible.

**Before use, make sure the air intake and outlet grilles are unobstructed.**

## AIR-CONDITIONING WITHOUT INSTALLATION

Just a few simple steps and your comfort is ensured with your air conditioner:

- Screw the hose adaptor **13** to the hose's end **12**.
- Fit the air exhaust hose in the housing at the back of the appliance. Insert it as shown in figure **A**.

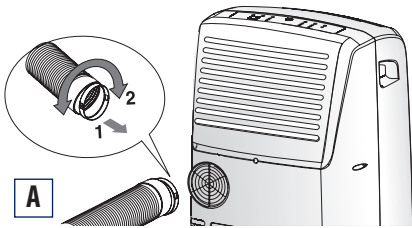

- Screw the window outlet **17** to the other end of the exhaust hose (see fig. **B**).

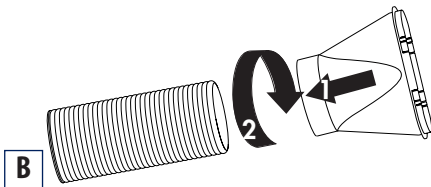

## Sash window

- Open the window.
- Place the window bracket **15** in the window, extending it to fit the width of the window (fig. **C**).
- Place the air conditioner near the window. Insert the assembled exhaust hose **12** into the window bracket hole **15**.
- Make sure the air exhaust hose is unobstructed.
- If you have a very large window, in order to cover your window aperture, use the additional window bracket without holes extending it to the desired dimension, then fix the bracket by using the locking pin provided. When extracting the window bracket and joining the two pieces pay attention you do not cover the hole.

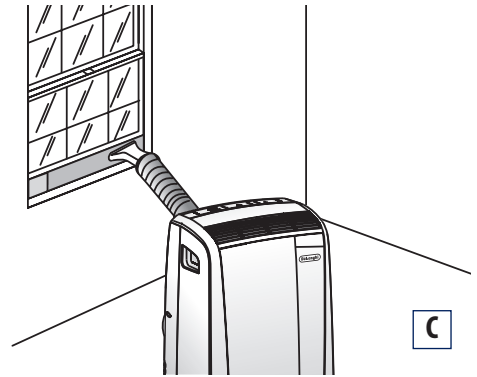

## Other set-up methods:

- Thanks to the locking pin, it's possible to use the window bracket also for sliding windows. Position the hole of the bracket so to allow a correct installation of the exhaust hose (see figure **D**).

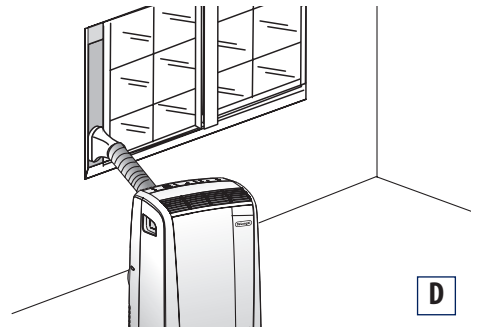

Keep the air hoses as short and free of curves as possible to avoid constrictions.

## French window

- After having screwed the window outlet **17** into the air exhaust hose **12**, open the French window slightly and position the window outlet **17** as shown in figure **E**.



## SEMI-PERMANENT INSTALLATION

If required, your appliance can also be installed semi-permanently (Fig. F).

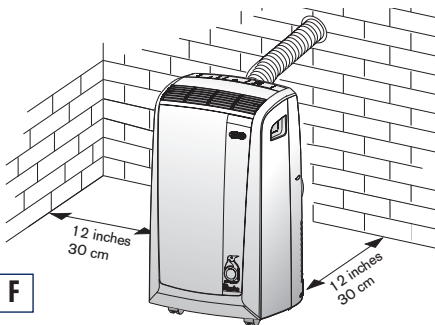

Proceed as follows:

- Drill a hole (ø134mm / 5.27 in.) in an outside wall or through a window pane.  
Respect the height and dimensions of the hole given in figures **F** and **G**.

**NOTE:** As special tools are required for installation, we suggest you have the appliance installed by specialized personnel.

**KEEP THE AIR HOSES AS SHORT AND FREE OF CURVES AS POSSIBLE TO AVOID CONSTRICTIONS.**

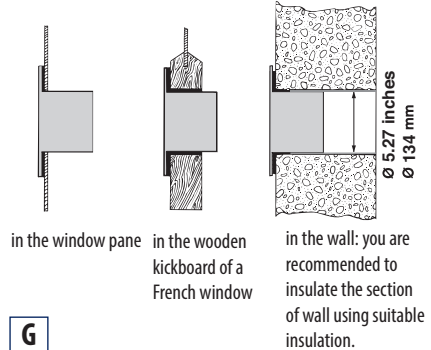

**G**

- Fit the wall flange **11** into the hole.
- Screw the hose adaptor **13** to the hose's end **12**.
- Fit the air exhaust hose in the housing at the back of the appliance as shown in figure **A**.
- Screw the wall mounting accessory **14** into the hose **12** (fig. **H**) and fit it into the wall flange **11** as shown in fig. **I**.

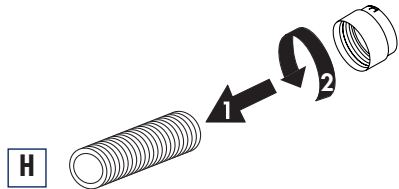

**H**

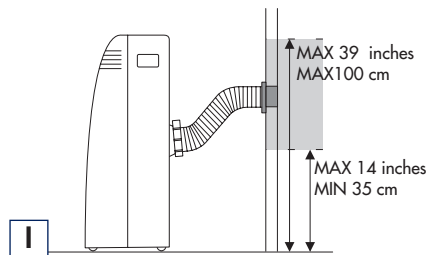

**I**

When the hose **12** is not fitted, the hole can be closed with the flange cap **11**.

**NOTE:** When installing the air conditioner semi-permanently, you should leave a door slightly open (as little as 1/2" (1 cm)) to guarantee correct ventilation.



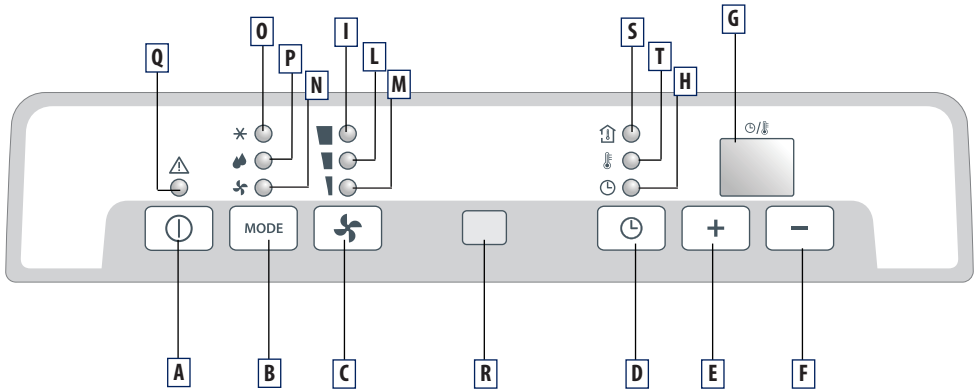

## DESCRIPTION OF THE CONTROL PANEL

- A ON/OFF button**
- B MODE selection button**  
Air conditioning, dehumidifying, fan.
- C Fan speed selection button (MAX/MED/MIN)**
- D Timer button**
- E Increase temperature/programmed operation time button**
- F Decrease temperature/programmed operation time button**
- G Display** Displays the temperature values and the programmed operating time
- H Timer in operation indicator light**
- I/L/M Fan speed lights**
- N Fan mode light**
- O Air-conditioning mode light**
- P Dehumidifying mode light**
- Q Alarm light**
- R Remote control receiver**
- S Light: the inner temperature is shown on the display**
- T Light: the outdoor temperature is shown on the display**

Never turn the air conditioner off by unplugging from the outlet. Always press the  button, then wait for a few minutes before unplugging. This allows the appliance to perform a cycle of checks to verify operation.

## TURNING THE APPLIANCE ON

**Before plugging the appliance check the caps on the back of the unit are correctly inserted and screwed on the drainage hose 10.**

Plug into the electrical receptacle. Two lines appear on the display indicating that the appliance is in stand-by. Press the **ON/OFF** button (A). When turned on, the air conditioner starts operating in the same mode as when it was turned off. Press the **MODE** button (B) until the light corresponding to the desired mode lights up:

- Light (O): **air-conditioning** mode
- Light (P): **dehumidifying** mode
- Light (N): **fan** mode

## AIR CONDITIONING MODE

Ideal for hot muggy weather when you need to cool and dehumidify the room.



The display shows the inner temperature: the light (S) turns on. To modify the set temperature, push the (E) or (F) button to reach the desired temperature. The (T) light turns on and the (S) light turns off.

To change from °F to °C or viceversa, press for few seconds both button E and F.

After 15 seconds, the inner temperature is shown on the display.

The (S) light turns on.

You can adjust the temperature only in air conditioning mode. Then select the fan speed by pressing the **FAN** button (C) until the light corresponding to the required fan speed lights up:

- MAX:**  the air conditioner operates at maximum to achieve the target temperature as rapidly as possible
- MED:**  reduces noise levels while maintaining a comfortable temperature
- MIN:**  for silent operation

*The most suitable indoor temperature for the room during the summer varies from 75°F to 81°F (24 to 27°C). You are recommended, however, not to set a temperature much below the outdoor temperature.*

## FAN MODE

Adjust fan speed by pressing the **FAN** button (C) as described for the air-conditioning mode.

Remember that the higher the speed, the more air is filtered. If you select “**MIN**” speed, less air is filtered but the appliance is also less noisy.

## DEHUMIDIFYING MODE

Ideal for reducing the humidity in a room without lowering or raising the temperature (spring or autumn, damp rooms, rainy spells, etc). When the dehumidifying mode is selected, the light (P) comes on. At the same time, the “**MIN**” fan speed light (M) comes on. In this mode, other speeds cannot be selected. In dehumidifying mode, the appliance **MUST** be set-up in the same way as for air conditioning, with the air exhaust hose **12** attached.

## PROGRAMMING THE TIMER

The timer can be used to delay appliance start up or shut down. This avoids wasting electricity by optimising operating periods.

### How to programme delayed start up

- Plug the appliance into an electrical receptacle and press the ON/OFF button (A), then select the required operating mode and other settings (temperature, fan speed, etc).
- Press the ON/OFF button (A) again to place the appliance in standby mode.
- Press the timer button (D). The timer light “**H**” flashes.
- Use the + (E) or - (F) buttons to set the number of hours delay before the appliance comes on. The time increases or decreases in steps of one hour.

The indicator light (H) flashes until the appliance starts up. You can set the appliance to come on with a delay of up to 12 hours. To cancel the timer programme, press the timer button (D) again. Light (H) stops flashing.

### How to programme delayed shut down

- Delayed shut down can be programmed in any operating mode (air conditioning/fan/dehumidifying).
- Press the timer button (D). The timer light “**H**” flashes.
- Use the + (E) or - (F) buttons to set the number of hours delay before the appliance goes off.

The time increases or decreases in steps of one hour.

The light (H) flashes until the appliance turns off as programmed. At the set time, the air conditioner shuts down and remains in standby. To cancel the timer programme, press the timer button (D) again. Light (H) stops flashing.

## USING THE REMOTE CONTROL

- Point the remote control at the receiver on the air conditioner. The remote control must be no more than 16,4ft (5 meters) away from the appliance (without obstacles between the remote

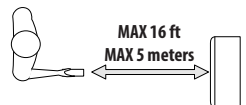

control and the receiver).

- The remote control must be handled with extreme care. Do not drop it or expose it to direct sunlight or sources of heat.

## DESCRIPTION OF THE REMOTE CONTROL

- 19) "ON/OFF" button
- 20) Increase/Decrease button for temperature/programmed use
- 21) "MODE" button
- 22) "TIMER" button
- 23) °F/°C scale button
- 24) Fan speed selection button (MAX/MED/MIN).

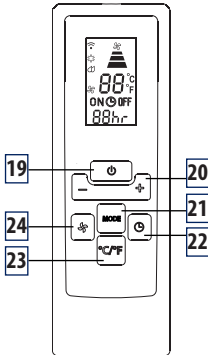

## Inserting or replacing the batteries

- Remove the cover on the rear of the remote control;
- Remove the old batteries, if present.
- Correctly insert two new L03 "AAA" 1,5V batteries (see the instructions inside the battery compartment);
- Replace the cover.

**If the remote control unit is replaced or discarded, the batteries must be removed and disposed of in accordance with current legislation as they are harmful to the environment. Do not mix old and new batteries. Do not mix alkaline, standard (carbon-zinc) or rechargeable (nickel-cadmium) batteries. Do not dispose of batteries in fire. Batteries may explode or leak. If the remote control will not be used for a certain length of time, remove the batteries.**

- **Note:** This equipment has been tested and found to comply with the limits for a Class B digital device, pursuant to part 15 of the FCC Rules. These limits are designed to provide reasonable protection against harmful interference in a residential installation.
- This equipment generates, uses and can radiate radio frequency energy and, if not installed and used in accordance with the instructions, may cause harmful interference to radio communications. However, there is no guarantee that interference will not occur in a particular installation. If this equipment does cause harmful interference to radio or television reception, which can be determined by turning the equipment off and on, the user is encouraged to try to correct the interference by one or more of the following measures:
  - Reorient or relocate the receiving antenna.
  - Increase the separation between the equipment and receiver.
  - Connect the equipment into an outlet on a circuit different from that to which the receiver is connected.
  - Consult the dealer or an experienced radio/TV technician for help. Changes or modifications not expressly approved by the party responsible for compliance could void the user's authority to operate the equipment.
- This device complies with Part 15 of the FCC Rules. Operation is subject to the following two conditions: (1) this device may not cause harmful interference, and (2) this device must accept any interference received, including interference that may cause undesired operation.
- This Class B digital apparatus complies with Canadian CAN ICES-3 (B) / NMB-3 (B).

## TURNING THE APPLIANCE ON

Plug the appliance into the the electrical receptacle.

Press the **ON/OFF** button (19) (when turned on, the air conditioner starts operating in the same mode as when it was turned off).

Press the **MODE** button (21) to select the required mode

### COOLING

### DEHUMIDIFYING

### FAN ONLY

On the control panel, the light corresponding to the selected mode comes on.

For air conditioning/dehumidifying/fan only settings and programming the timer, see page 8.

To get the best from your air conditioner, follow these recommendations:

- close the windows and doors in the room to be air conditioned.

The only exception is when the appliance is installed through a hole in the wall.

In this case, you are recommended to leave a slight draught through a door or window to guarantee correct ventilation.

- Protect the room from direct exposure to the sun by partially closing curtains and/or blinds to make the appliance much more economical to run;
- Never rest objects of any kind on the air conditioner;
- Never obstruct the air intake or outlet grilles **1-6-8**.
- Make sure there are no heat sources in the room.

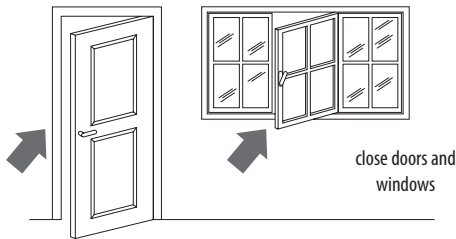

- Never use the appliance in very damp rooms (laundries for example).
- Never use the appliance outdoors.

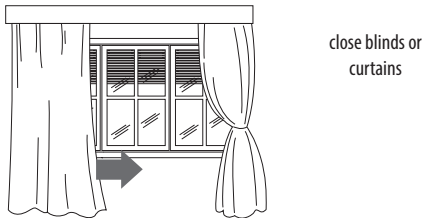

- Make sure the air conditioner is on a **level floor**.

**Before cleaning or maintenance, turn the appliance off by pressing the ON/OFF button (A) or in models with remote control unit, by pressing the ON/OFF button 19, then always unplug the appliance from the electrical receptacle.**

## CLEANING THE CABINET

You should clean the appliance with a slightly damp cloth then dry with a dry cloth.

For safety reasons, never wash the air conditioner with water.

## Precautions

Never use petrol, alcohol or solvents to clean the appliance. Never spray insecticide liquids or similar.

## CLEANING THE AIR FILTER

To keep your air conditioner working efficiently, you should clean the dust filter every week of operation.

The filter is housed in the intake grille.

To clean the filter, remove the filter as shown in figure L.

Use a vacuum cleaner to remove the dust collected on the filter.

If it is very dirty, immerse in warm water and rinse a number of times. The water should never be hotter than 104°F (40°C). After washing, leave the filter to dry. Put the filter back in its housing.

## START OF SEASON CHECKS

Make sure the power cable and plug are undamaged and the ground connection is efficient. Follow the installation instructions precisely.

## END OF SEASON OPERATIONS

To drain all water from the circuit, remove the external cap by unscrewing it in the anticlockwise direction then, remove the internal cap from the drain hose on the back of the appliance and allow the water to drain out into a basin (figure M). When the appliance is empty, replace the caps.

Clean the filter and dry thoroughly before putting back.

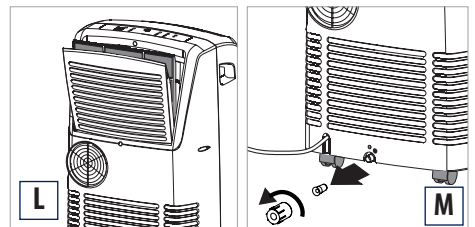



**NOTE:**

**NEVER TRANSPORT OR TURN THE APPLIANCE UPSIDE DOWN OR ON ITS SIDE. IF THIS OCCURS, WAIT 6 HOURS BEFORE TURNING THE APPLIANCE ON, 24 HOURS IS RECOMMENDED.** (After the unit has been on its side, oil needs to return to the compressor to ensure proper function. Without allowing the unit this time (6-24 hours) The unit may function for only a short time, and then the compressor will break down from lack of oil.

PROBLEM	CAUSE	REMEDY
<b>The air conditioning unit does not start.</b>	<ul style="list-style-type: none"> <li>No electricity.</li> <li>It is not plugged into the electrical receptacle.</li> <li>The safety device of the plug has tripped.</li> </ul>	<ul style="list-style-type: none"> <li>Wait.</li> <li>Plug into the electrical receptacle.</li> <li>Reset the safety device, if problem persists contact our toll free customer service.</li> </ul>
<b>The air conditioning unit works for a short time only.</b>	<ul style="list-style-type: none"> <li>The air exhaust hose has a constriction.</li> <li>The air exhaust hose is blocked.</li> <li>There are tight bends in the air exhaust hose.</li> </ul>	<ul style="list-style-type: none"> <li>Position the exhaust hose correctly.</li> <li>Check there are no obstacles that obstruct the air discharge.</li> <li>Eliminate the tight bends.</li> </ul>
<b>The air conditioner works, but does not cool the room.</b>	<ul style="list-style-type: none"> <li>Window open.</li> <li>The exhaust hose is detached.</li> <li>Air filter clogged.</li> </ul>	<ul style="list-style-type: none"> <li>Close the window.</li> <li>Connect the exhaust hose.</li> <li>Clean or replace the filter.</li> </ul>
<b>Unpleasant smell in the room</b>	<ul style="list-style-type: none"> <li>Air purifying filter clogged</li> </ul>	<ul style="list-style-type: none"> <li>Clean or replace the filters.</li> </ul>
<b>The air conditioner does not operate for about 3 minutes after turning it on</b>	<ul style="list-style-type: none"> <li>The safety device has tripped</li> </ul>	<ul style="list-style-type: none"> <li>Wait for three minutes.</li> </ul>
<b>The alarm light Q comes on</b>	<ul style="list-style-type: none"> <li>The tank inside the appliance is full.</li> </ul>	<ul style="list-style-type: none"> <li>Empty the tank (see "End of season operations" on page 10).</li> </ul>

**SELF-DIAGNOSIS**

The appliance has a self diagnosis system to identify a number of malfunctions. Error messages are displayed on the appliance display.

IF... IS DISPLAYED,	IF... IS DISPLAYED,	IF... IS DISPLAYED,
 <p>"Low Temperature" ...MEANS: room temperature is too low</p>	 <p>"High Temperature" ...MEANS: room temperature is too high</p>	 <p>"Probe Failure" (sensor damaged) ...MEANS: contact your local customer service</p>

## TECHNICAL SPECIFICATION

Power supply voltage	see rating label
Max. absorbed power during air conditioning	“
Refrigerant	“
Cooling capacity	“

## LIMIT CONDITIONS

Room temperature for air conditioning	64 ÷ 104°F 18 ÷ 40°C
---------------------------------------	----------------------

**Transport, filling, cleaning, recovery and disposal of refrigerant should be performed by a technical service centre appointed by the manufacturer only. The appliance should be disposed of by a specialist centre appointed by the manufacturer only.**

**NEVER TRANSPORT OR TURN THE APPLIANCE UPSIDE DOWN OR ON ITS SIDE. IF THIS OCCURS, WAIT 6 HOURS BEFORE TURNING THE APPLIANCE ON, 24 HOURS IS RECOMMENDED.** (After the unit has been on its side, oil needs to return to the compressor to ensure proper function. Without allowing the unit this time (6-24 hours) The unit may function for only a short time, and then the compressor will break down from lack of oil).

This appliance is equipped with a **3 prong grounded plug**. The plug must be connected into an outlet that is properly installed and grounded in the accordance with all local codes and ordinances. Do not modify the plug provided with the appliance. If it will not fit the outlet, have a proper outlet installed by a qualified electrician or relocate the unit to a proper outlet.

If the household electrical supply does not meet the above specifications, or if you are not sure your home has an effective electrical ground, have a qualified electrician or your local electrical utility company check it and correct any problems.

## SAFETY PLUG

The appliance is fitted with a safety plug to protect the power cable.

If power is cut off, unplug from the outlet and make sure the power cable is undamaged.

If the cable is damaged, call the service center immediately.

If power cuts off frequently and the power cable is undamaged, contact a qualified electrician.

## OPERATION OF THE SAFETY PLUG

If the safety device incorporated in the plug trips and cuts off the power supply, check that the power cable and plug are not damaged.

If the power cable is undamaged, to restore operation **press** the “**RESET**” button.

To verify correct operation of the plug, **press** the “**TEST**” button periodically and make sure the appliance disconnects. If this is not the case, contact the service center.

To restore operation, **press** the “**RESET**” button.