

MAGNIFICA — EVO —



QUICK START GUIDE

DeLonghi

Need help?



SCAN HERE

ECAM29084SB



EASILY REGISTER YOUR MACHINE & GET MORE OUT OF YOUR ESPRESSO EXPERIENCE

Register your Fully Automatic Espresso Machine and become De'Longhi Club Member. Join the De'Longhi Club to get more out of your coffee experience.



RECEIVE 1
ADDITIONAL YEAR
OF WARRANTY
FOR REGISTERING
PRODUCT



MEMBERSHIP
DISCOUNT ON
ACCESSORIES



PRIVATE
ONLINE SALES



DE'LONGHI
SPECIALIST
SUPPORT



EASY
ORDERING



EXCLUSIVE
COFFEE EVENTS
& NEWS

De'Longhi Club Member discount: Only members of the Club will receive special offers on coffee accessories.

STEP #1: TAKE A PHOTO

- Snap a photo of the camera icon, including the points.

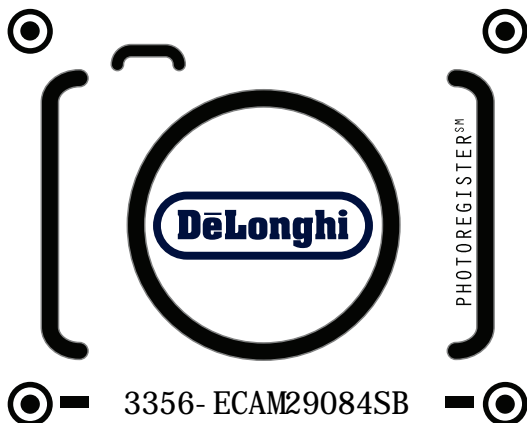

STEP #2: SEND PHOTO

- Send a photo via text, Facebook Messenger or upload online.



TEXT PHOTO
TO 71403



MESSANGER @
PHOTOREGISTER



ONLINE:
WWW.DELONGHI.PHOTO

NEED HELP?:

Visit photoregister.com/help
or text HELP to 71403.

CONTACT US

- Call 1-800-945-0929
- Online: Delonghi.com

VISIT US AT DELONGHI.COM



IN THE BOX

- A1. Beans container
- A2. Pre-ground coffee funnel lid
- A3. Beans container lid
- A4. Grinding adjustment dial
- A5. Pre-ground coffee funnel
- A6. Steam/hot water nozzle
- A7. Coffee spouts (adjustable height)
- A8. Condensate tray
- A9. Grounds container
- A10. Cup tray

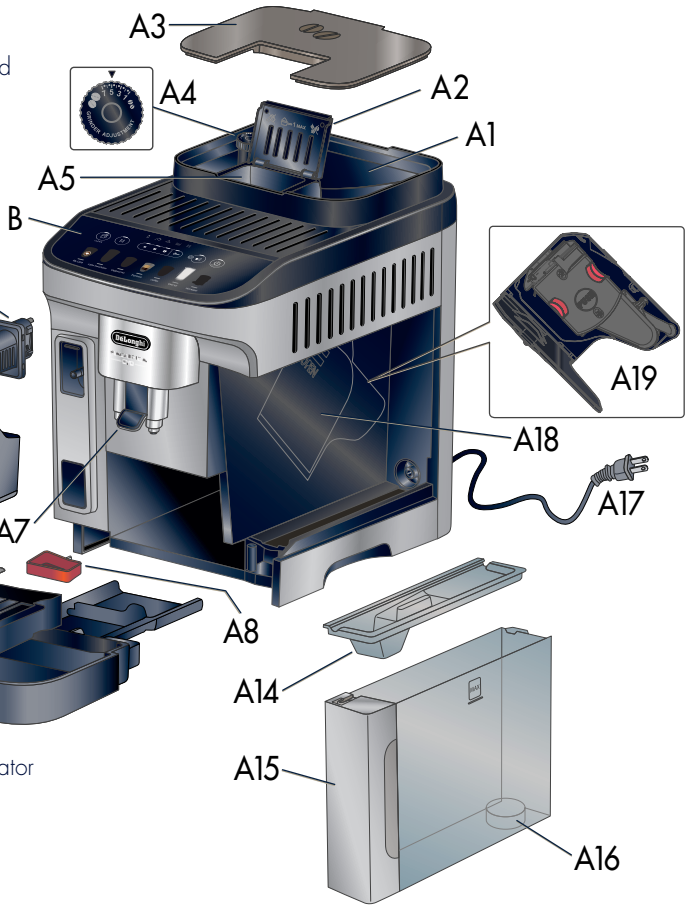

- A11. Drip tray water level indicator
- A12. Drip tray grille
- A13. Drip tray
- A14. Water tank lid
- A15. Water tank
- A16. Water filter housing
- A17. Power cord
- A18. Infuser door
- A19. Infuser

B. Control Panel



Get Started &
Owner's Instructions
Booklets

This short guide is not intended to explain all the functions of the appliance. Please read all the owner's instruction booklet before use.

ECAM29084SB

ACCESSORIES INCLUDED

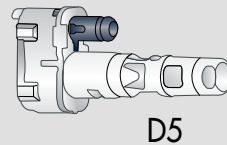
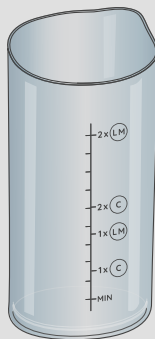
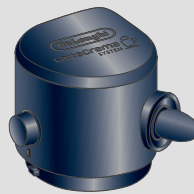
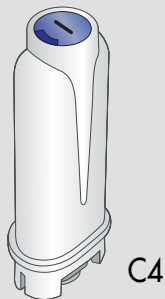
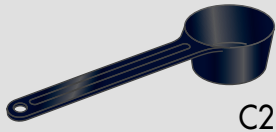
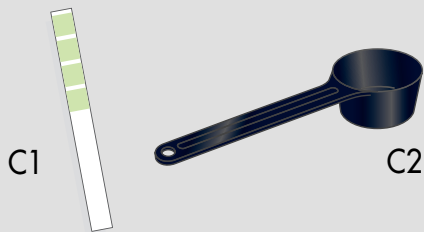

- C1. "Total Hardness Test" indicator paper
- C2. Pre-ground coffee measuring scoop
- C3. Descaler
- C4. Water softener filter (certain models only)

- D1. Milk Spout
- D2. Milk Container lid
- D3. Milk container
- D4. Milk intake tube
- D5. Milk container connector

CONTROL PANEL & DISPLAY

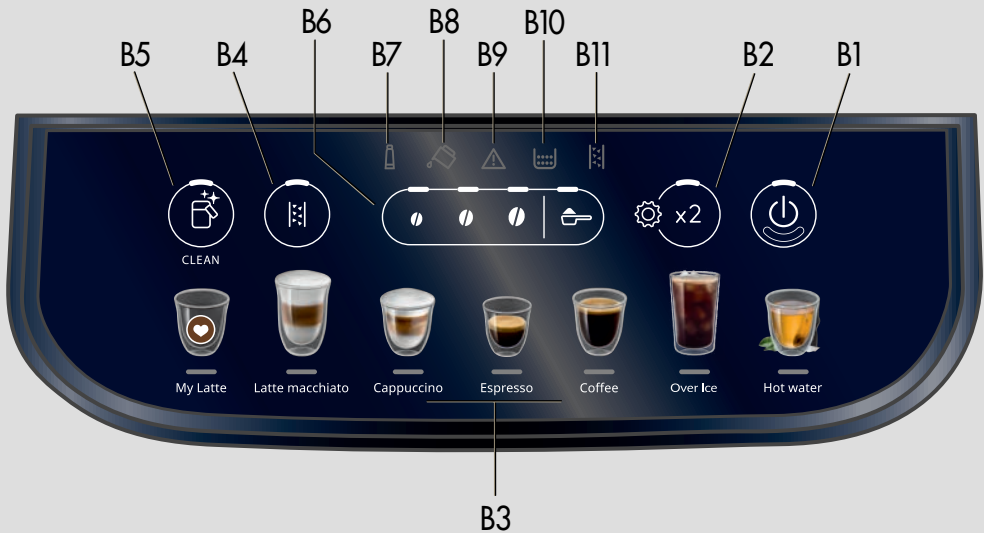

- B1. ON/Off Button
- B2. X2 button / Rinsing function (when pressed and hold for 5 seconds)
- B3. Direct recipes
- B4. Setting menu button
- B5. Milk Clean / Descaling button
- B6. Strength selection and pre-ground function buttons
- B7. Exhausted water filter indicator light
- B8. Water indicator light
- B9. General alarm indicator light
- B10. Ground container light
- B11. Descaling indicator light

GET READY

Remove all stickers and clean all accessories with warm water and mild detergent and dry them. Priming the machine is only required the first time out of the box.

1 Connect the machine to the mains socket. The Water indicator Light will turn on.

2 Fill the water tank with fresh water

3 General alarm and Hot water lights start blinking. Connect the Hot Water Spout to the machine.

4 Add a large water container under both the water/steam spout and coffee spouts. Press the Setting button, which is now blinking.

5 Hot water will be delivered by the water spout.

6 The machine is now primed: it heats up and delivers hot water by the coffee spouts. The machine is and ready for use.

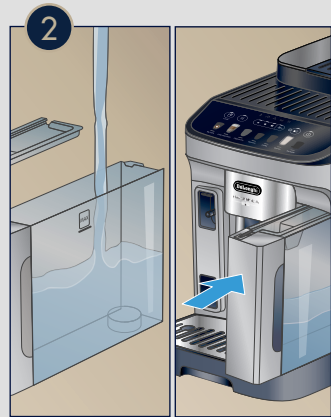
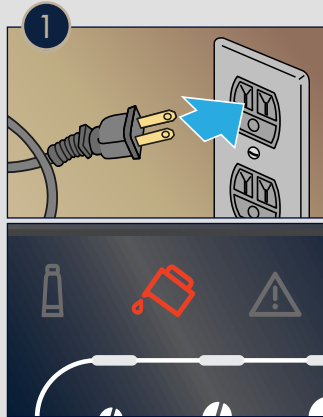

BREW ESPRESSO

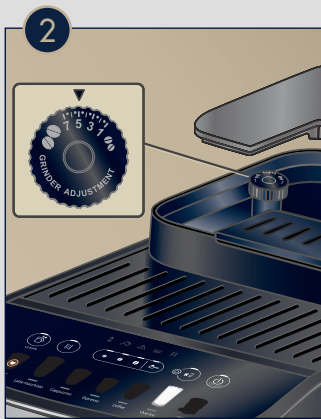

The first time using the machine, brew and dump the first 3-4 espressos. If you haven't been using the machine for 3-4 days, perform a rinsing cycle (press and hold **X2** Button for about 5 seconds).



2 To brew the perfect espresso set your grinder following the "Extraction Guidelines" on page 10.

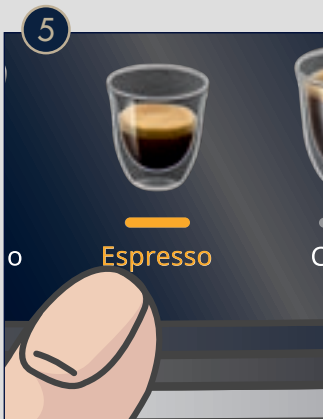

5 Select one of the recipes on the touch screen. Preparation will start with default strength and quantity, which can be changed by customizing your recipes.

6 To Brew doppio, first press the **X2** button and then select your espresso recipe.

MILK RECIPIES

To make a Milk recipe, use the provided milk container. Use cold cow milk or your preferred milk alternative. Whole milk or oat milk will give the best results.

1 Open the Milk container lid by twisting clockwise, in the direction of  and make sure the intake tube is correctly insert.

2 Fill the container with cold cow milk or your preferred plant based milk alternative. The graduated scale on the side of the container will give you indications on how much milk to use based on the different recipes.

3 Lock the milk container lid by twisting counterclockwise, in the direction of .

4 Remove the water spout and insert the milk container.

5 Place a cup under the milk and coffee spouts and press the desired milk recipe.

6 To clean the milk system, place an empty container under the milk spout and press the Milk Clean button.

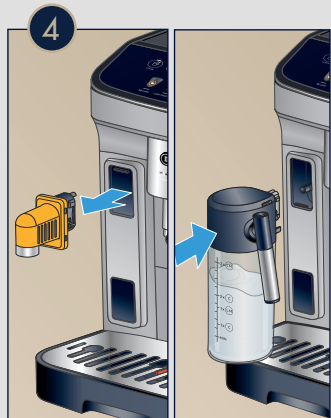
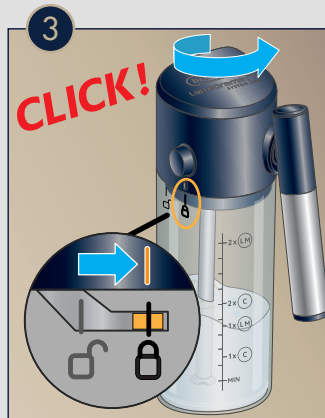
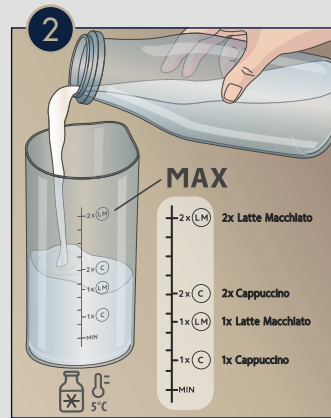
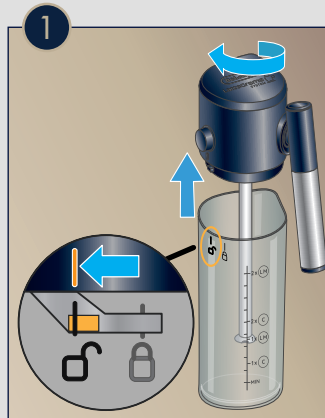

CUSTOMIZE RECIPES

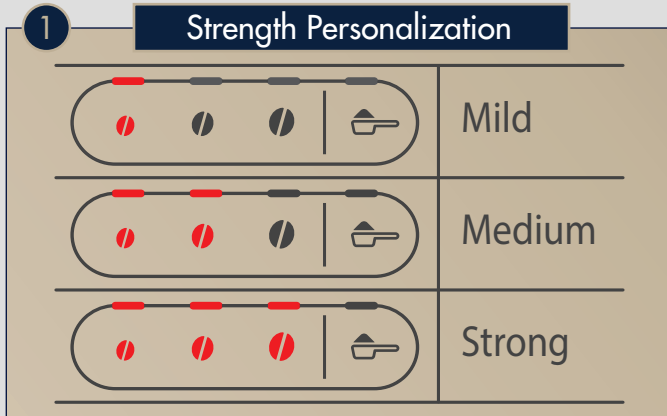

1 Strength Personalization:
Personalize the strength of recipes by selecting the desired option.



2 Quantity Personalization:
You can change the default quantity by pressing and holding the button of the recipe you want to modify until it blinks. Delivery begins. Press again to stop at the desired level. The new parameter is now saved.



3 Pre-ground:
To use pre-ground coffee, press the icon ☕ and add one measuring scoop of pre-ground coffee in the dedicated funnel, then select the desired recipe.

EXTRACTION GUIDELINES

Depending on your choice of beans, you might need to adjust the grinder setting to a finer or more coarse choice.



- Flow like warm honey
- Nut-brown Crema
- Well balanced and lingering taste

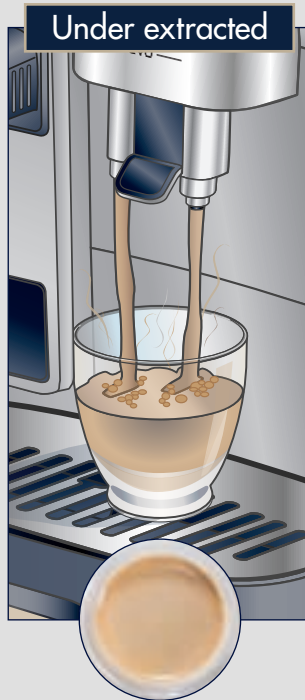

- Flowing fast like water
- Light and pale Crema

To make it perfect:

- Adjust grinding setting to a finer setting
- Select a higher strength

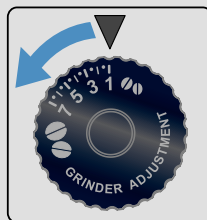

- Flowing in drips or not at all
- Crema very dark and not uniform

To make it perfect:

- Adjust grinding setting to a coarser setting
- Select a lower strength

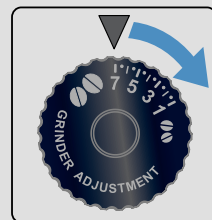

CLEANING

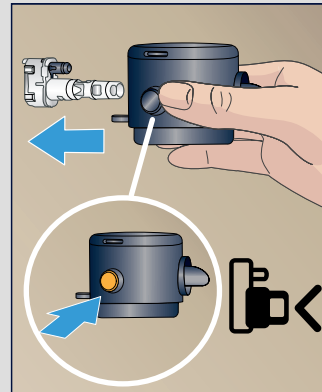
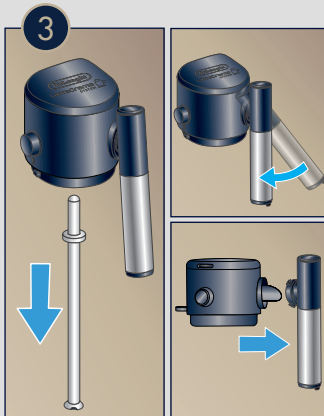
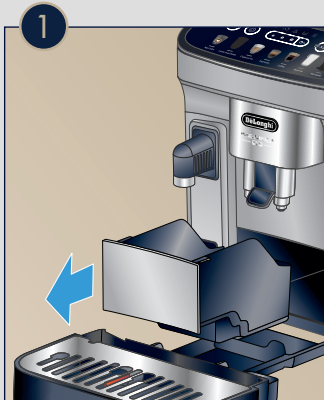

Keeping your machine clean will improve quality of the beverage and life span of the machine.

1 Empty drip tray daily and empty coffee ground container when lights come up.

2 Once a month, clean the inside of the machine. Follow User Manual detailed instructions.

3 Remove intake tube by simply pulling. Remove the Milk Spout by positioning it vertically and then pulling it out. Clean these parts by hand or dishwasher.

4 Press the button to extract the Milk lid connector and clean it by hand or dishwasher.

5 Promptly descale when indication light comes on. The frequency of the need to descale of the machine depends on the water hardness setting. See User Manual for more information and detailed instructions.

DESCALING



ECAM29084SB

INSERT WATER FILTER

To ensure better quality of the water install the provided water filter. Under normal use, filters last about 2 months. If coffee maker is left unused, the filter will last a maximum of 3 weeks*. You can purchase extra filters on www.delonghi.com
 *The type of filter may vary.

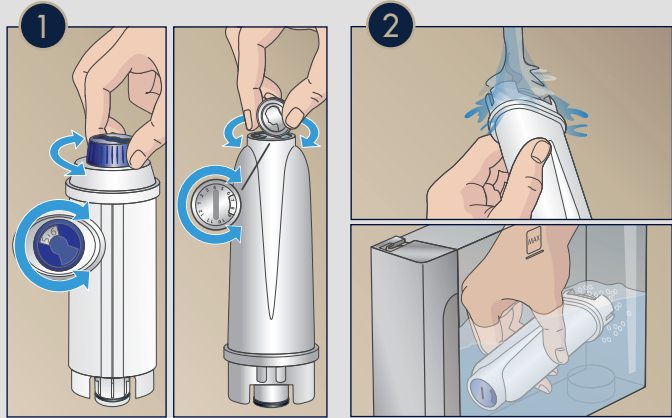

1 Turn the date indicator disk until the next two months are displayed.

2 Fill the filter with water submerge it inside the filled water tank, until all air bubbles have escaped.

3 Place the filter in the filter housing on the tank and cover with the lid. Put the water tank back in the machine.

4 Insert the Hot Water Spout.

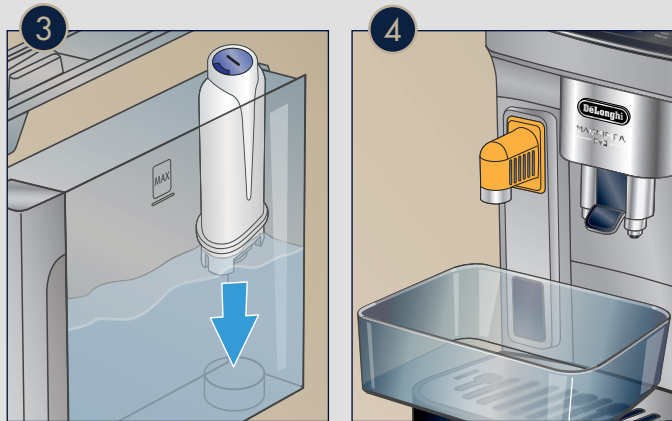

5 Now you have to tell the machine you installed a new filter. Proceed by pressing the button sequence shown in the picture.

6 Water will be delivered and will stop automatically. The filter is now successfully installed.

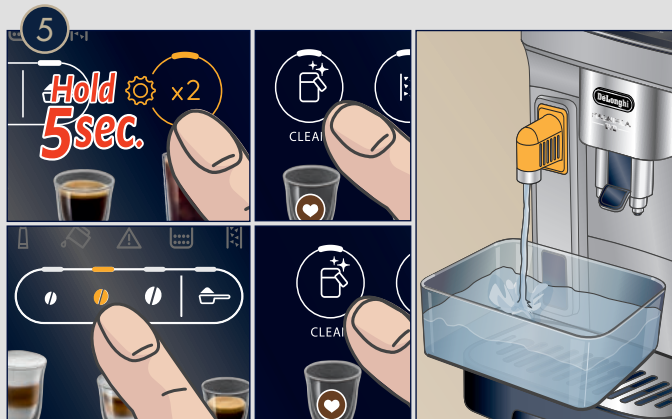

Note the machine will let you know when it's time to substitute the filter when the  light will turn on.

SET WATER HARDNESS

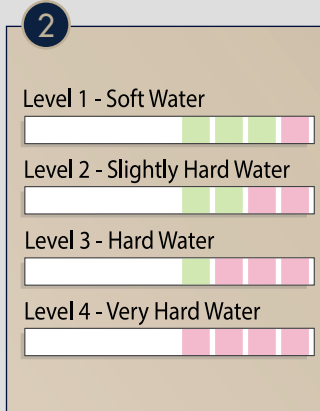

Analyze the hardness of your water to set your machine accordingly.

1 Dip the provided Total Hardness Indicator in a glass of water for one second and shake it.

2 Wait a couple of minutes. Read the Indicator paper colors and compare with this table.

3 Set Water Hardness on your machine by accessing the setting menu pressing for 5 seconds and then pressing .

4 Use the Strength selector to choose the water level, based on the water hardness test results.

5 Confirm Selection by pressing Coffee . Exit the setting menu by pressing .





ACCESSORIES

Enjoy our full line of drinkware:
an exclusive line of Espresso, Cappuccino and Latte glasses.



Coffee Care & Maintenance

Experience the De'Longhi Care Kit Line to improve
the performance of your fully automatic machine.



Descaler



Descaler mini



Water Filter



Coffee Care Kit



Multi-Clean

... to learn more about the De'Longhi accessories visit: delonghi.com

